

B215HT046, 1/2", High Temperature CCV Stainless Steel Ball and Stem



Technical Data

Service	high temperature hot water/low pressure steam, up to 60% glycol
Flow Characteristic	A-port equal percentage
Controllable Flow Range	75°
Size [mm]	0.5" [15]
End Fitting	NPT female ends
Body	nickel plated brass (DZR) P-CuZn35Pb2
Ball	stainless steel
Stem	stainless steel
Stem Packing	Viton O-ring
Seat	ETFE
Seat O-ring	EPDM (lubricated)
Characterized Disc	ETFE
Body Pressure Rating [psi]	600
Max Inlet Pressure (Steam)	15 psi
Media Temperature Range (Water)	60°F to 266°F [16°C to 130°C]
Media Temperature Range (Steam)	250°F [120°C]
Maximum Differential Pressure (Steam)	15 psi
Max Differential Pressure (Water)	60 psi partially open ball, 116 psi full open
Close-Off Pressure	200 psi
Cv	0.46
Weight	0.7 lb [0.3 kg]
Leakage	0%
Servicing	maintenance free

Flow Pattern

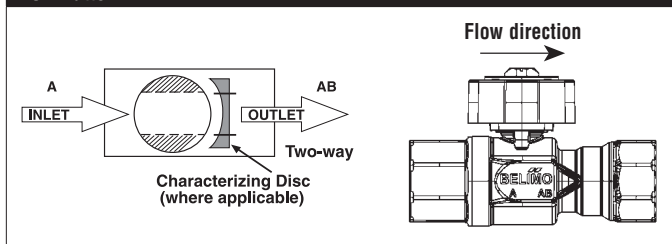

Application

This valve is typically used in air handling units on heating or cooling coils, and fan coil unit heating or cooling coils. Some other common applications include unit ventilators, VAV box re-heat coils and bypass loops. This valve is suitable for use in a hydronic system with variable flow. This valve is designed to fit in compact areas where on/off, floating point and modulating control is required using 24 VAC.

Suitable Actuators

	Non-Spring	Spring
B215HT046	TR, LR	TFR

Dimensions (Inches [mm])

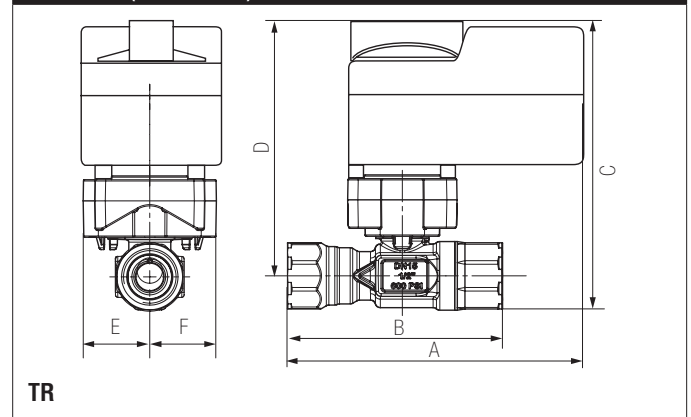

A	B	C	D	E	F
4.16" [106]	3.33" [85]	5.44" [138]	4.91" [125]	1.48" [38]	

Date created, 06/30/2017 - Subject to change. © Belimo Aircontrols (USA), Inc.

Dimensions (Inches [mm])

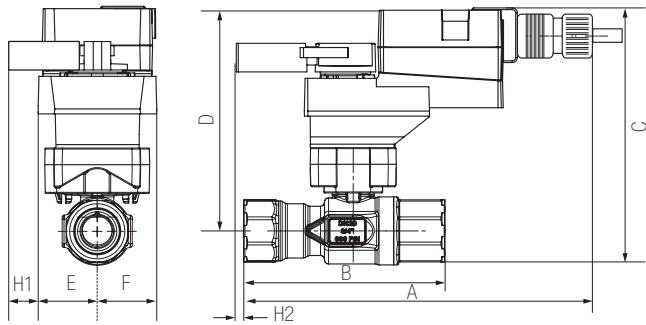

LRB, LRX

A	B	C	D	E	F	H1	H2
8.32" [211]	3.33" [85]	5.8" [147]	5.3" [135]	1.3" [33]		1.18" [30]	0.5" [15]

Dimensions (Inches [mm])

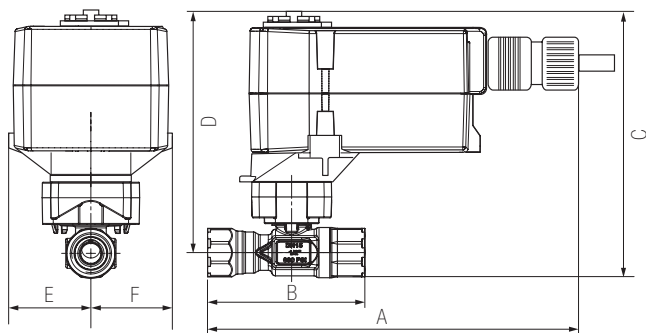

TFRB, TFRX

A	B	C	D	E	F
7.32" [186]	3.33" [85]	5.8" [147]	5.3" [135]	1.52" [39]	1.52" [38.5]

TFRX24-MFT

Modulating, Spring Return, Multi-Function Technology®



Technical Data	
Power Supply	24 VAC ± 20%, 50/60 Hz, 24 VDC ± 10%
Power Consumption Running	2.5 W
Power Consumption Holding	1 W
Transformer Sizing	4 VA (class 2 power source)
Electrical Connection	3ft [1m], 10ft [3m] or 16ft [5m] 18 GA appliance or plenum cables, with or without 1/2" conduit connector
Overload Protection	electronic throughout 0° to 95° rotation
Operating Range Y	2 to 10 VDC, 4 to 20 mA w/ ZG-R01 (500 Ω, 1/4 W resistor)
Input Impedance	100 k Ω for 2 to 10 VDC (0.1 mA), 500 Ω for 4 to 20 mA, 1500 Ω for PWM, floating point and On/Off
Feedback Output U	2 to 10 VDC, 0.5 mA max, VDC variable
Angle of Rotation	Max. 95°, 90°
Direction of Rotation (Motor)	reversible with built-in switch
Direction of Rotation (Fail-Safe)	reversible with CW/CCW mounting
Position Indication	visual indicator, 0° to 95° (0° is full spring return position)
Running Time (Motor)	150 sec (default), variable (75 to 300 sec)
Running Time (Fail-Safe)	<25 sec
Ambient Humidity	max. 95% RH non-condensing
Ambient Temperature Range	-22°F to 122°F [-30°C to 50°C]
Storage Temperature Range	-40°F to 176°F [-40°C to 80°C]
Housing	NEMA 2, IP42, UL enclosure type 2
Housing Material	UL94-5VA
Agency Listings†	cULus acc. to UL60730-1A/-2-14, CAN/CSA E60730-1:02, CE acc. to 2004/108/EC and 2006/95/EC
Noise Level (Motor)	<35 dB (A)
Noise Level (Fail-Safe)	<62 dB (A)
Servicing	maintenance free
Quality Standard	ISO 9001
Weight	1.8 lb [0.8 kg]

*Variable when configured with MFT options.

†Rated Impulse Voltage 800V, Type of action 1.AA, Control Pollution Degree 3

Date created, 08/04/2017 - Subject to change. © Belimo Aircontrols (USA), Inc.

Wiring Diagrams
INSTALLATION NOTES

- Actuators with appliance cables are numbered.
- Provide overload protection and disconnect as required.
- Actuators may be connected in parallel. Power consumption and input impedance must be observed.
- Actuators may also be powered by 24 VDC.
- Two built-in auxiliary switches (2x SPDT), for end position indication, interlock control, fan startup, etc.
- Only connect common to negative (-) leg of control circuits.
- A 500 Ω resistor (ZG-R01) converts the 4 to 20 mA control signal to 10 VDC.
- Control signal may be pulsed from either the Hot (Source) or Common (Sink) 24 VAC line.
- For triac sink the Common connection from the actuator must be connected to the Hot connection of the controller. Position feedback cannot be used with a triac sink controller; the actuator internal common reference is not compatible.
- IN4004 or IN4007 diode. (IN4007 supplied, Belimo part number 40155).
- Actuators with plenum cable do not have numbers; use color codes instead.
- Meets cULus requirements without the need of an electrical ground connection.

WARNING! LIVE ELECTRICAL COMPONENTS!
 During installation, testing, servicing and troubleshooting of this product, it may be necessary to work with live electrical components. Have a qualified licensed electrician or other individual who has been properly trained in handling live electrical components perform these tasks. Failure to follow all electrical safety precautions when exposed to live electrical components could result in death or serious injury.

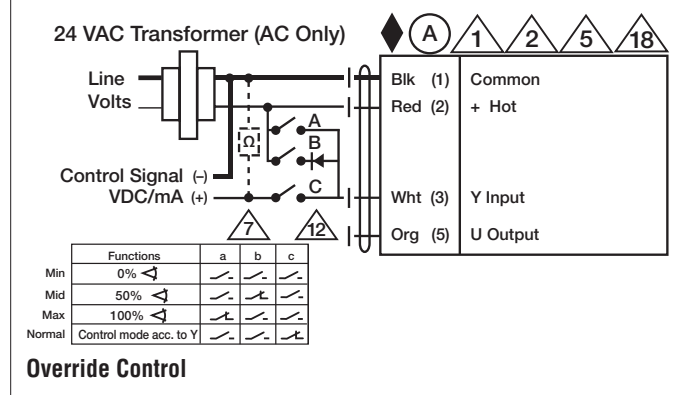
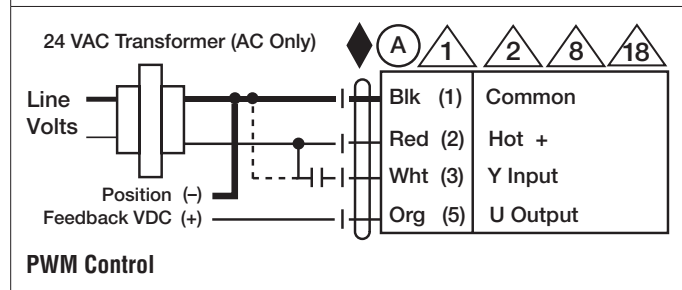
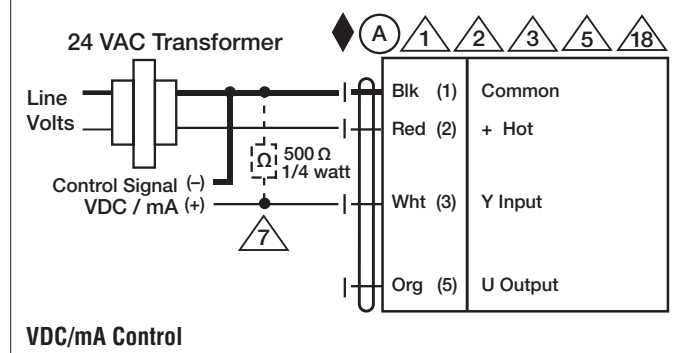
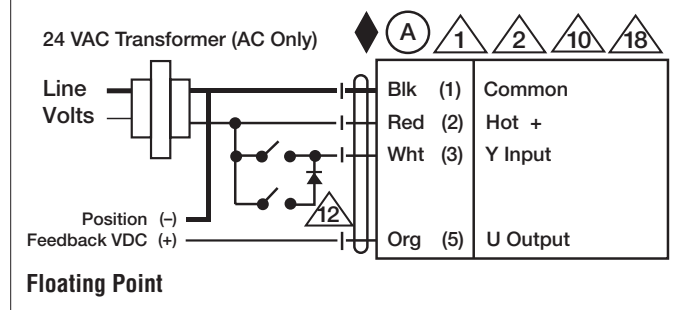
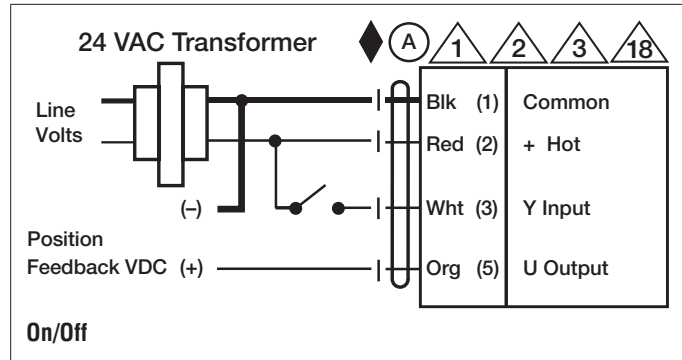

Date created, 08/04/2017 - Subject to change. © Belimo Aircontrols (USA), Inc.