

B215HT116, 1/2", High Temperature CCV Stainless Steel Ball and Stem



Technical Data

Service	high temperature hot water/low pressure steam, up to 60% glycol
Flow Characteristic	A-port equal percentage
Controllable Flow Range	75°
Size [mm]	0.5" [15]
End Fitting	NPT female ends
Body	nickel plated brass (DZR) P-CuZn35Pb2
Ball	stainless steel
Stem	stainless steel
Stem Packing	Viton O-ring
Seat	ETFE
Seat O-ring	EPDM (lubricated)
Characterized Disc	ETFE
Body Pressure Rating [psi]	600
Max Inlet Pressure (Steam)	15 psi
Media Temperature Range (Water)	60°F to 266°F [16°C to 130°C]
Media Temperature Range (Steam)	250°F [120°C]
Maximum Differential Pressure (Steam)	15 psi
Max Differential Pressure (Water)	60 psi partially open ball, 116 psi full open
Close-Off Pressure	200 psi
Cv	1.16
Weight	0.7 lb [0.3 kg]
Leakage	0%
Servicing	maintenance free

Flow Pattern

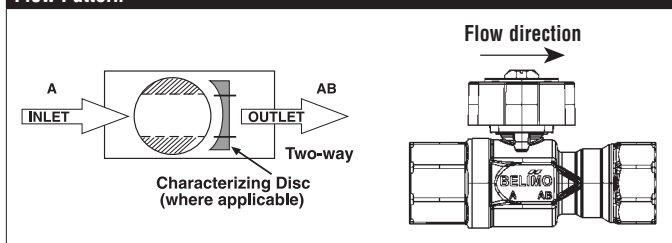

Application

This valve is typically used in air handling units on heating or cooling coils, and fan coil unit heating or cooling coils. Some other common applications include unit ventilators, VAV box re-heat coils and bypass loops. This valve is suitable for use in a hydronic system with variable flow. This valve is designed to fit in compact areas where on/off, floating point and modulating control is required using 24 VAC.

Suitable Actuators

	Non-Spring	Spring
B215HT116	TR, LR	TFR

Dimensions (Inches [mm])

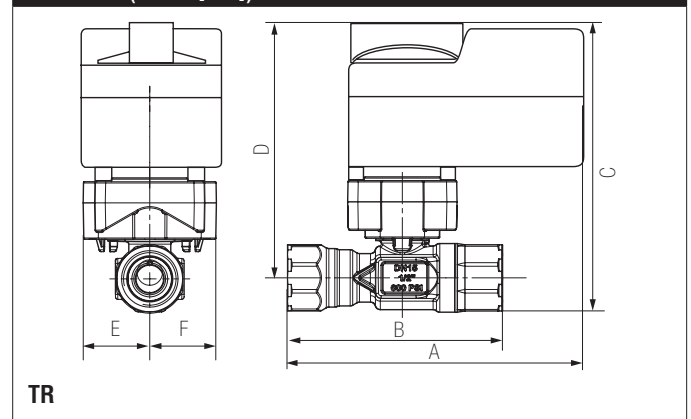

A	B	C	D	E	F
4.16" [106]	3.33" [85]	5.44" [138]	4.91" [125]	1.48" [38]	

Date created, 06/30/2017 - Subject to change. © Belimo Aircontrols (USA), Inc.

Dimensions (Inches [mm])

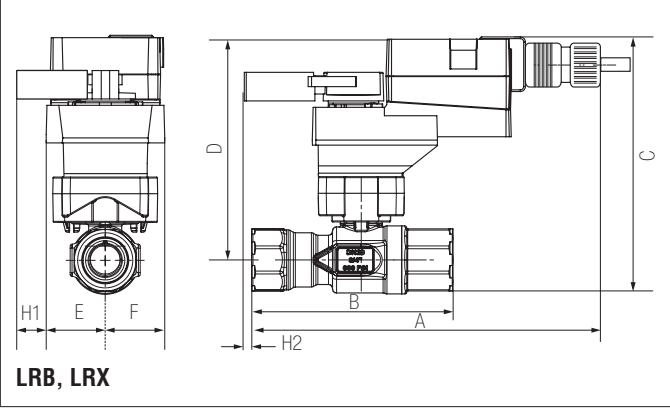

A	B	C	D	E	F	H1	H2
8.32" [211]	3.33" [85]	5.8" [147]	5.3" [135]	1.3" [33]		1.18" [30]	0.5" [15]

Dimensions (Inches [mm])

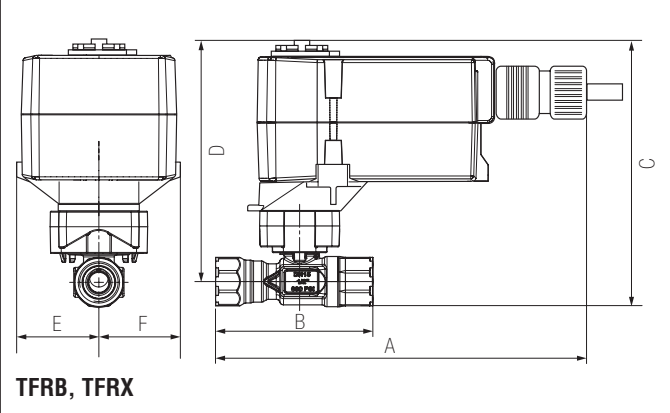

A	B	C	D	E	F
7.32" [186]	3.33" [85]	5.8" [147]	5.3" [135]	1.52" [39]	1.52" [38.5]

TR24-SR US

Modulating, Non-Spring Return, 24 V, for 2 to 10 VDC or 4 to 20 mA



Technical Data	
Power Supply	24 VAC \pm 20%, 50/60 Hz, 24 VDC \pm 10%
Power Consumption Running	0.5 W
Transformer Sizing	1 VA (class 2 power source)
Electrical Connection	3ft [1m], 18 GA plenum rated cable
Overload Protection	electronic throughout full rotation
Operating Range Y	2 to 10 VDC, 4 to 20 mA w/ ZG-R01 (500 Ω , 1/4 W resistor)
Input Impedance	100 k Ω for 2 to 10 VDC (0.1 mA), 500 Ω for 4 to 20 mA
Angle of Rotation	90°
Direction of Rotation (Motor)	reversible with protected switch
Position Indication	integrated into handle
Manual Override	push down handle
Running Time (Motor)	90 sec
Ambient Temperature Range	-22°F to 122°F [-30°C to 50°C]
Storage Temperature Range	-40°F to 176°F [-40°C to 80°C]
Housing	NEMA type 1 / IP40
Agency Listings†	cULus acc. to UL60730-1A/-2-14, CAN/CSA E60730-1:02, CE acc. to 2004/108/EC and 2006/95/EC
Noise Level (Motor)	<35 dB (A)
Servicing	maintenance free
Quality Standard	ISO 9001

† Rated impulse voltage 500V, Control pollution degree 2, Type of action 1.
NOTE: Response Sensitivity is 75 mV

Wiring Diagrams
INSTALLATION NOTES

- Provide overload protection and disconnect as required.
- Actuators may also be powered by 24 VDC.
- Only connect common to negative (-) leg of control circuits.
- A 500 Ω resistor (ZG-R01) converts the 4 to 20 mA control signal to 2 to 10 VDC.
- Actuators may be connected in parallel if not mechanically linked. Power consumption and input impedance must be observed.
- Meets cULus requirements without the need of an electrical ground connection.

WARNING! LIVE ELECTRICAL COMPONENTS!
 During installation, testing, servicing and troubleshooting of this product, it may be necessary to work with live electrical components. Have a qualified licensed electrician or other individual who has been properly trained in handling live electrical components perform these tasks. Failure to follow all electrical safety precautions when exposed to live electrical components could result in death or serious injury.

