

# B219, 2-Way, Characterized Control Valve

## Stainless Steel Ball and Stem



### Technical Data

Service	chilled, hot water, up to 60% glycol
Flow Characteristic	equal percentage
Controllable Flow Range	75°
Size [mm]	0.75" [20]
End Fitting	NPT female ends
Body	forged brass, nickel plated
Ball	stainless steel
Stem	stainless steel
Stem Packing	EPDM (lubricated)
Seat	Teflon® PTFE
Seat O-ring	EPDM (lubricated)
Characterized Disc	TEFZEL®
Body Pressure Rating [psi]	600
Media Temperature Range (Water)	0°F to 250°F [-18°C to 120°C]
Max Differential Pressure (Water)	50 psi (345 kPa)
Close-Off Pressure	200 psi
Cv	10
Weight	0.7 lb [0.3 kg]
Leakage	0% for A to AB
Servicing	maintenance free

### Flow Pattern



### Application

This valve is typically used in air handling units on heating or cooling coils, and fan coil unit heating or cooling coils. Some other common applications include Unit Ventilators, VAV box re-heat coils and bypass loops. This valve is suitable for use in a hydronic system with variable flow.

### Suitable Actuators

	Non-Spring	Spring
B219	TR, LR, NR	TFR, LF

### Dimensions (Inches [mm])



A	B	C	D	E	F	H1	H2
9.4" [239]	2.73" [69]	5.79" [147]	5.09" [129]	1.3" [33]		1.18" [30]	1" [25]

Date created, 10/27/2017 - Subject to change. © Belimo Aircontrols (USA), Inc.

## B219, 2-Way, Characterized Control Valve Stainless Steel Ball and Stem

Dimensions (Inches [mm])



TR

A	B	C	D	E	F
4" [101]	2.73" [69]	5.39" [137]	5.09" [129]	1.3" [33]	

Dimensions (Inches [mm])

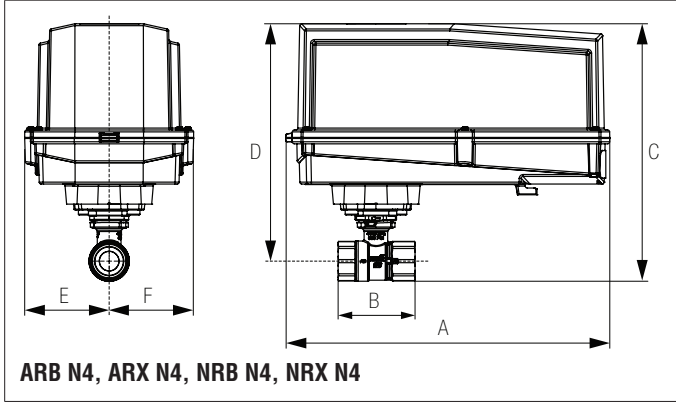

ARB N4, ARX N4, NRB N4, NRX N4

A	B	C	D	E	F
11.36" [289]	2.73" [69]	7.85" [199]	7.15" [181]	3.15" [80]	

Dimensions (Inches [mm])

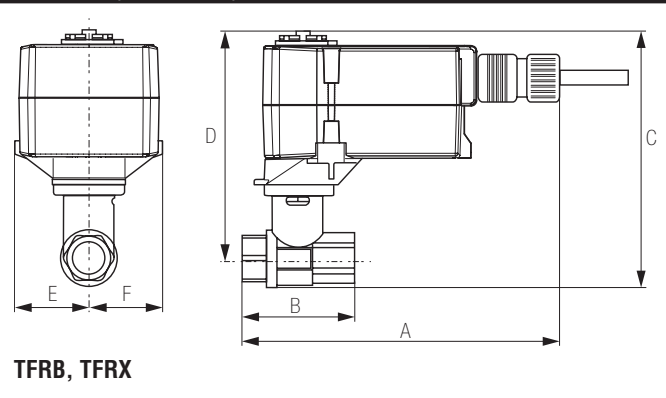

TFRB, TFRX

A	B	C	D	E	F
6.95" [177]	2.73" [69]	5.5" [140]	4.8" [122]	1.53" [38]	

Dimensions (Inches [mm])

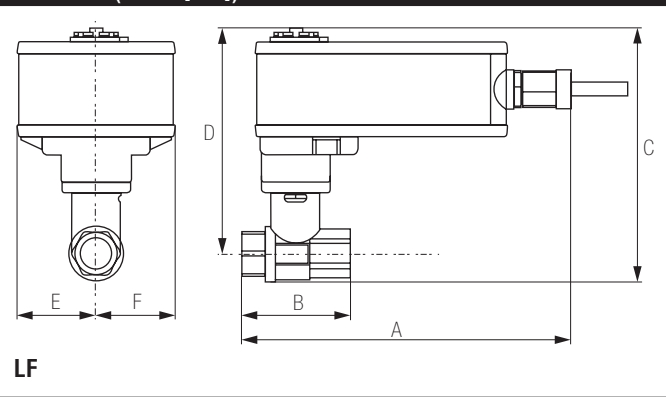

LF

A	B	C	D	E	F
8.58" [218]	2.73" [69]	6.27" [159]	5.57" [141]	1.82" [46]	

# LRX24-PC



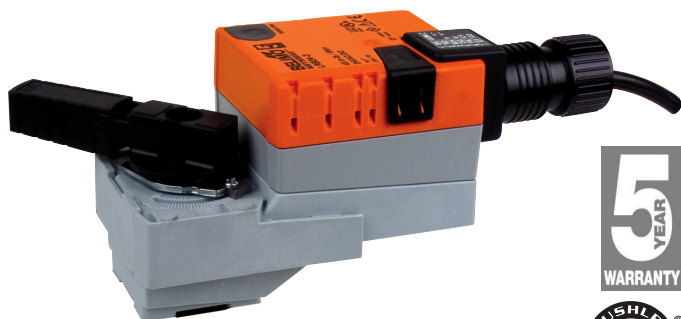

## Modulating, Non-Spring Return, 24 V, 0 to 20 V Phasecut



Technical Data	
Power Supply	24 VAC ± 20%, 50/60 Hz, 24 VDC ± 10%
Power Consumption Running	2.5 W
Power Consumption Holding	1.2 W
Transformer Sizing	5 VA (class 2 power source)
Electrical Connection	18 GA plenum rated cable with 1/2" conduit connector protected NEMA 2 (IP54) 3ft [1m] 10ft [3m] and 16ft [5m]
Overload Protection	electronic throughout 0° to 90° rotation
Operating Range Y	0 TO 20 V phasecut control is only for the positive part of the sine wave (max. of 10 volts)
Input Impedance	8000 Ω (50mW)
Feedback Output U	2 to 10 VDC, 0.5 mA max
Angle of Rotation	90°
Direction of Rotation (Motor)	reversible with built-in switch
Position Indication	integrated into handle
Manual Override	external push button
Running Time (Motor)	90 sec (default), Optional (90 or 150 sec)
Ambient Temperature Range	-22°F to 122°F [-30°C to 50°C]
Storage Temperature Range	-40°F to 176°F [-40°C to 80°C]
Housing	NEMA 2, IP54, UL enclosure type 2
Agency Listings†	cULus acc. to UL60730-1A/-2-14, CAN/CSA E60730-1:02, CE acc. to 2004/108/EC
Noise Level (Motor)	<35 dB (A)
Servicing	maintenance free
Quality Standard	ISO 9001

†Rated Impulse Voltage 800V, Type of Action 1, Control Pollution Degree 2.

**Wiring Diagrams**

-  Provide overload protection and disconnect as required.
-  Actuators may be connected in parallel. Power consumption and input impedance must be observed.
-  Actuators may also be powered by 24 VDC.
-  Only connect common to negative (-) leg of control circuits.

