

B261, 2-Way, Characterized Control Valve

Stainless Steel Ball and Stem



Technical Data	
Service	chilled, hot water, up to 60% glycol
Flow Characteristic	equal percentage
Controllable Flow Range	75°
Size [mm]	2.5" [65]
End Fitting	NPT female ends
Body	forged brass, nickel plated
Ball	stainless steel
Stem	stainless steel
Stem Packing	EPDM (lubricated)
Seat	Teflon® PTFE
Seat O-ring	EPDM (lubricated)
Characterized Disc	TEFZEL®
Body Pressure Rating [psi]	400
Media Temperature Range (Water)	0°F to 212°F [-18°C to 100°C]
Max Differential Pressure (Water)	30 psi
Close-Off Pressure	100 psi
Cv	60
Weight	8.2 lb [3.7 kg]
Leakage	0% for A to AB
Servicing	maintenance free



Application

This valve is typically used in air handling units on heating or cooling coils, and fan coil unit heating or cooling coils. Some other common applications include Unit Ventilators, VAV box re-heat coils and bypass loops. This valve is suitable for use in a hydronic system with variable flow.

Suitable Actuators

	Non-Spring	Spring
B261	ARB(X)	AFRB(X)

Dimensions (Inches [mm])



A	B	C	D	E	F	H1
10.1" [257]	5.55" [141]	7.98" [202]	5.98" [152]	2.78" [71]		1.88" [48]

Date created, 10/27/2017 - Subject to change. © Belimo Aircontrols (USA), Inc.

B261, 2-Way, Characterized Control Valve

Stainless Steel Ball and Stem

Dimensions (Inches [mm])



AFRB, AFRX

A	B	C	D	E	F
11.52" [293]	5.55" [141]	8.61" [220]	6.61" [168]	2.02" [51]	

Dimensions (Inches [mm])

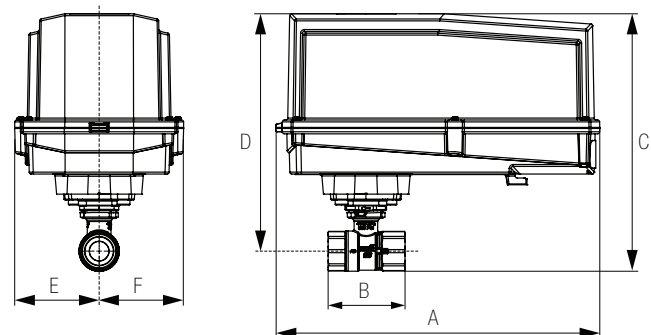

ARB N4, ARX N4, NRB N4, NRX N4

A	B	C	D	E	F
11.36" [289]	5.55" [141]	10.74" [274]	8.01" [204]	3.15" [80]	

Dimensions (Inches [mm])



ARQB, ARQX

A	B	C	D	E	F	H1	H2
9.9" [251]	4.21" [107]	8.11" [195]	6.11" [155]	2.28" [58]		0.75" [20]	0.5" [15]

Dimensions (Inches [mm])

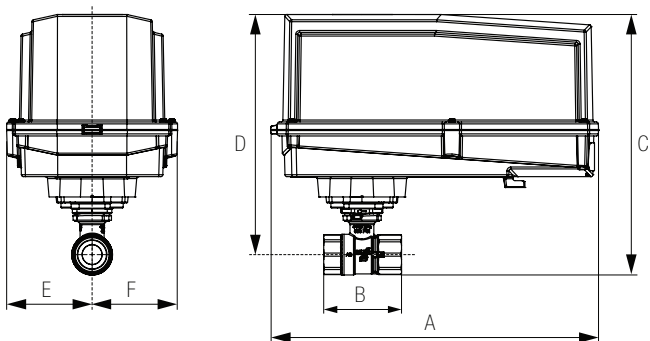

AFRB N4, AFRX N4

A	B	C	D	E	F
11.36" [289]	5.55" [141]	10.74" [274]	8.01" [204]	2.44" [62]	

ARX24-MFT95

Modulating, Non-Spring Return, 24 V, 0 to 135 Ω Input



Technical Data	
Power Supply	24 VAC, ±20%, 50/60 Hz, 24 VDC, ±10%
Power Consumption Running	3.5 W
Power Consumption Holding	1.3 W
Transformer Sizing	6 VA (class 2 power source)
Electrical Connection	18 GA plenum rated cable with 1/2" conduit connector protected NEMA 2 (IP54) 3ft [1m] 10ft [3m] and 16ft [5m]
Overload Protection	electronic throughout 0° to 90° rotation
Operating Range Y	0 to 135 Ω Honeywell Electronic Series 90, 0 to 135 Ω input
Input Impedance	100 k Ω
Feedback Output U	2 to 10 VDC, 0.5 mA max, VDC variable
Angle of Rotation	90°
Direction of Rotation (Motor)	reversible with built-in switch
Position Indication	integrated into handle
Manual Override	external push button
Running Time (Motor)	150 sec
Ambient Temperature Range	-22°F to 122°F [-30°C to 50°C]
Storage Temperature Range	-40°F to 176°F [-40°C to 80°C]
Housing	NEMA 2, IP54
Agency Listings†	cULus acc. to UL60730-1A/-2-14, CAN/CSA E60730-1:02, CE acc. to 2004/108/EC and 2006/95/EC
Noise Level (Motor)	<45 dB (A)
Servicing	maintenance free
Quality Standard	ISO 9001

†Rated Impulse Voltage 800V, Type action 1, Control Pollution Degree 3.

Date created, 11/30/2017 - Subject to change. © Belimo Aircontrols (USA), Inc.

Wiring Diagrams

INSTALLATION NOTES

- Provide overload protection and disconnect as required.
- Actuators may also be powered by 24 VDC.
- Actuators with plenum cable do not have numbers; use color codes instead.
- Actuators and controller must have separate transformers.
- Consult controller instruction data for more detailed information.
- Resistor value depends on the type of controller and the number of actuators. No resistor is used for one actuator. Honeywell® resistor kits may also be used.
- To reverse control rotation, use the reversing switch.
- Actuators may be controlled in parallel. Current draw and input impedance must be observed.
- Meets cULus requirements without the need of an electrical ground connection.

WARNING! LIVE ELECTRICAL COMPONENTS!
 During installation, testing, servicing and troubleshooting of this product, it may be necessary to work with live electrical components. Have a qualified licensed electrician or other individual who has been properly trained in handling live electrical components perform these tasks. Failure to follow all electrical safety precautions when exposed to live electrical components could result in death or serious injury.

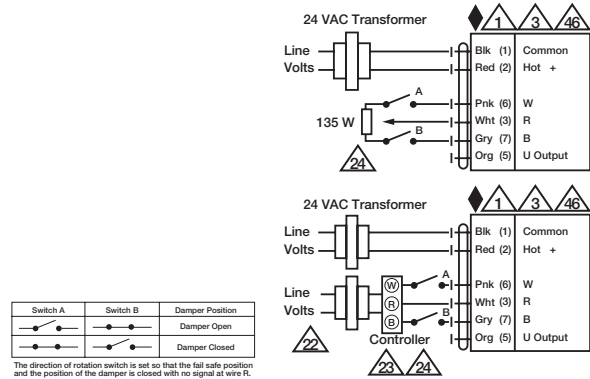

Typical and Override Control

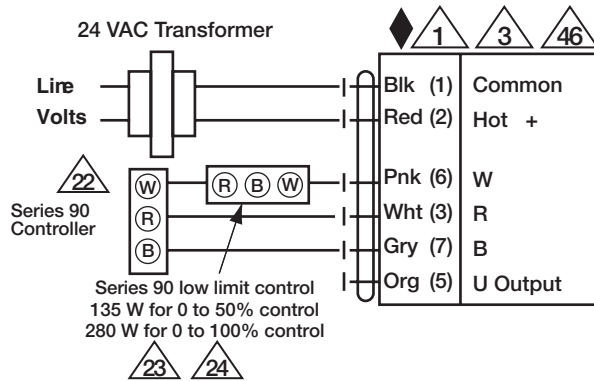

Low Limit Control

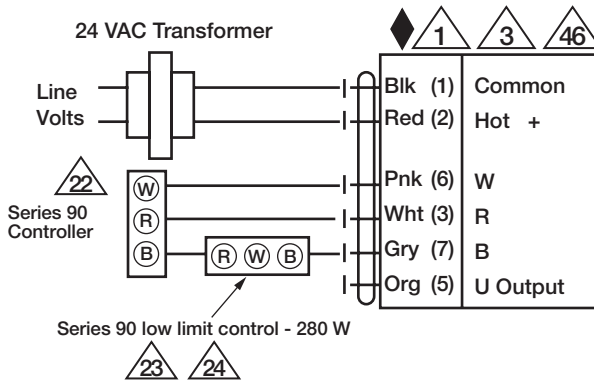

High Limit Control

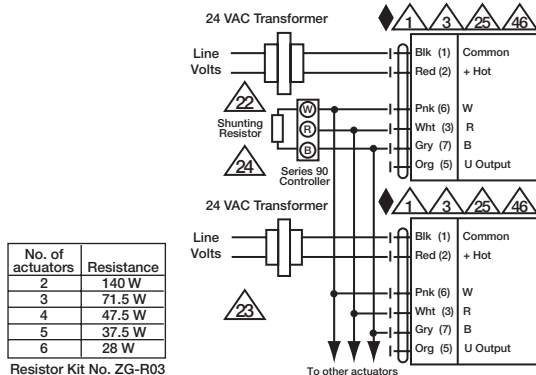

Multiple Actuators

No. of actuators	Resistance
2	140 W
3	71.5 W
4	47.5 W
5	37.5 W
6	28 W

Resistor Kit No. ZG-R03

ARX24-MFT95

Modulating, Non-Spring Return, 24 V, 0 to 135 Ω Input



Date created, 11/30/2017 - Subject to change. © Belimo Aircontrols (USA), Inc.



Multiple Actuators with Minimum Position Potentiometer



Multiple Actuators Used with W973, W7100 and T775