

# B262, 2-Way, Characterized Control Valve

## Stainless Steel Ball and Stem

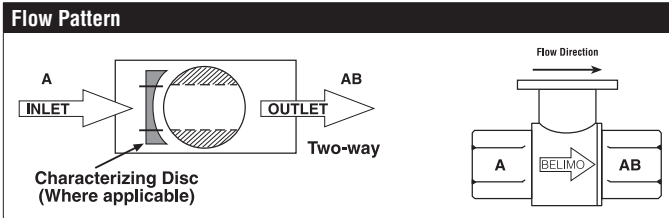

Technical Data	
Service	chilled, hot water, up to 60% glycol
Flow Characteristic	equal percentage
Controllable Flow Range	75°
Size [mm]	2.5" [65]
End Fitting	NPT female ends
Body	forged brass, nickel plated
Ball	stainless steel
Stem	stainless steel
Stem Packing	EPDM (lubricated)
Seat	Teflon® PTFE
Seat O-ring	EPDM (lubricated)
Characterized Disc	TEFZEL®
Body Pressure Rating [psi]	400
Media Temperature Range (Water)	0°F to 212°F [-18°C to 100°C]
Max Differential Pressure (Water)	30 psi
Close-Off Pressure	100 psi
Cv	75
Weight	8.2 lb [3.7 kg]
Leakage	0% for A to AB
Servicing	maintenance free



### Application

This valve is typically used in air handling units on heating or cooling coils, and fan coil unit heating or cooling coils. Some other common applications include Unit Ventilators, VAV box re-heat coils and bypass loops. This valve is suitable for use in a hydronic system with variable flow.

### Suitable Actuators

	Non-Spring	Spring
B262	ARB(X)	AFRB(X)

### Dimensions (Inches [mm])

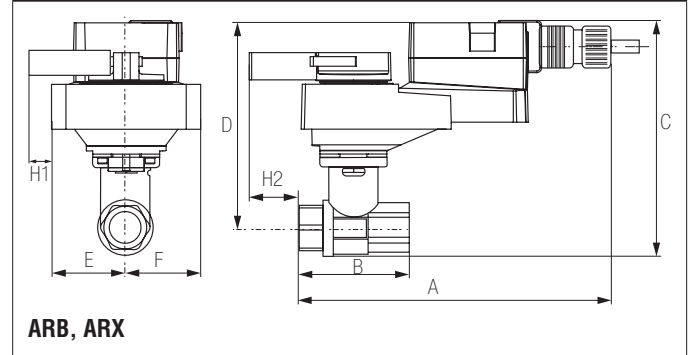

A	B	C	D	E	F	H1
10.1" [257]	5.55" [141]	7.98" [202]	5.98" [152]	2.78" [71]		1.88" [48]

Date created, 10/27/2017 - Subject to change. © Belimo Aircontrols (USA), Inc.

## B262, 2-Way, Characterized Control Valve Stainless Steel Ball and Stem

### Dimensions (Inches [mm])

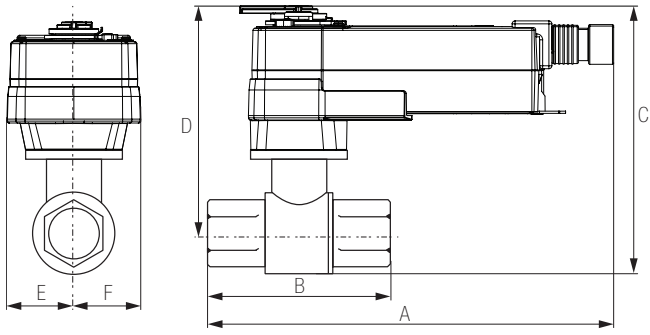

**AFRB, AFRX**

A	B	C	D	E	F
11.52" [293]	5.55" [141]	8.61" [220]	6.61" [168]	2.02" [51]	

### Dimensions (Inches [mm])

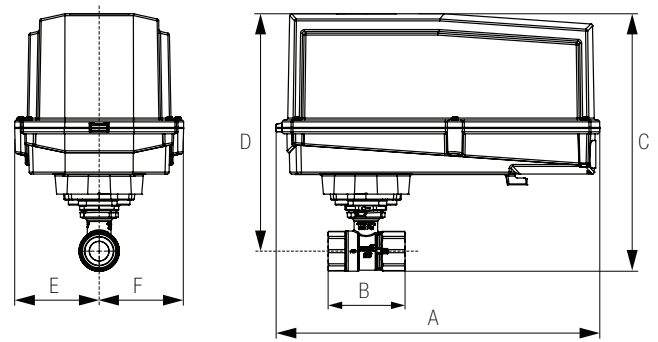

**ARB N4, ARX N4, NRB N4, NRX N4**

A	B	C	D	E	F
11.36" [289]	5.55" [141]	10.74" [274]	8.01" [204]	3.15" [80]	

### Dimensions (Inches [mm])

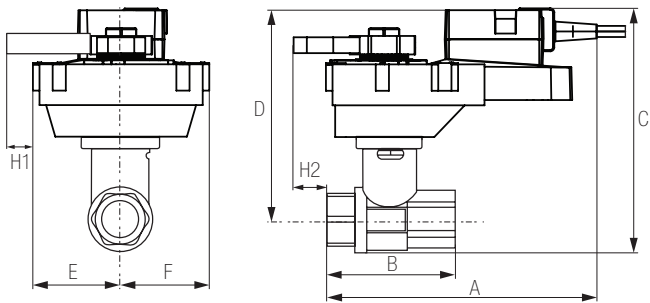

**ARQB, ARQX**

A	B	C	D	E	F	H1	H2
9.9" [251]	4.21" [107]	8.11" [195]	6.11" [155]	2.28" [58]		0.75" [20]	0.5" [15]

### Dimensions (Inches [mm])

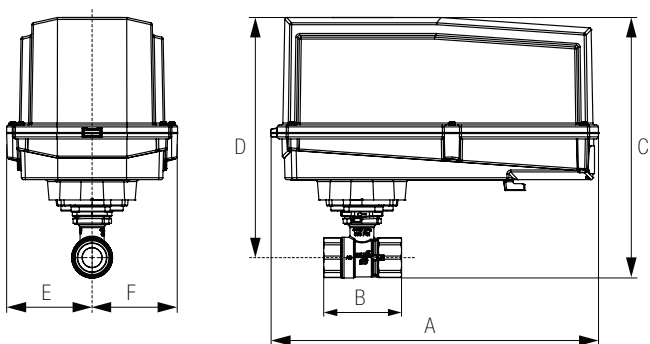

**AFRB N4, AFRX N4**

A	B	C	D	E	F
11.36" [289]	5.55" [141]	10.74" [274]	8.01" [204]	2.44" [62]	

# AFRXUP-S

On/Off, Spring Return, 24 to 240 VAC



Technical Data	
Power Supply	24...240 VAC -20% / +10%, 50/60 Hz, 24...125 VDC ±10%
Power Consumption Running	7 W
Power Consumption Holding	3.5 W
Transformer Sizing	7 VA @ 24 VAC (class 2 power source), 8.5 VA @ 120 VAC, 18 VA @ 240 VAC
Electrical Connection	(2) 3ft [1m], 18 GA appliance cables with 1/2" conduit connectors
Overload Protection	electronic throughout 0° to 95° rotation
Operating Range Y	on/off
Angle of Rotation	90°
Direction of Rotation (Motor)	reversible with CW/CCW mounting
Direction of Rotation (Fail-Safe)	reversible with CW/CCW mounting
Position Indication	visual indicator, 0° to 95° (0° is full spring return position)
Manual Override	5 mm hex crank (3/16" Allen), supplied
Running Time (Motor)	<75 sec
Running Time (Fail-Safe)	<20 sec
Ambient Temperature Range	-22°F to 122°F [-30°C to 50°C]
Storage Temperature Range	-40°F to 176°F [-40°C to 80°C]
Housing	NEMA 2, IP54, UL enclosure type 2
Agency Listings†	cULus acc. to UL60730-1A/-2-14, CAN/CSA E60730-1:02, CE acc. to 2004/108/EC and 2006/95/EC
Noise Level (Motor)	<45 dB (A)
Noise Level (Fail-Safe)	<62 dB (A)
Servicing	maintenance free
Quality Standard	ISO 9001
Auxiliary Switch	2 x SPDT, 3A resistive (0.5A inductive) @ 250 VAC, one set at +10°, one adjustable 10° to 90°

†Rated Impulse Voltage 800V, Type of action 1.AA, Control Pollution Degree 3

Date created, 08/14/2017 - Subject to change. © Belimo Aircontrols (USA), Inc.

**Wiring Diagrams**

**INSTALLATION NOTES**

- Actuators with appliance cables are numbered.
- Universal Power Supply (UP) models can be supplied with 24 VAC up to 240 VAC, or 24 VDC up to 125 VDC.
- Provide overload protection and disconnect as required.
- Actuators may be powered in parallel. Power consumption must be observed.
- Parallel wiring required for piggy-back applications.
- Meets cULus requirements without the need of an electrical ground connection.

**WARNING! LIVE ELECTRICAL COMPONENTS!**  
During installation, testing, servicing and troubleshooting of this product, it may be necessary to work with live electrical components. Have a qualified licensed electrician or other individual who has been properly trained in handling live electrical components perform these tasks. Failure to follow all electrical safety precautions when exposed to live electrical components could result in death or serious injury.

