

B307B, 3-Way, Characterized Control Valve

Chrome Plated Brass Ball and Nickel Plated Brass Stem



Technical Data	
Service	chilled, hot water, up to 60% glycol
Flow Characteristic	A-port Equal percentage; B-port modified linear for constant flow
Controllable Flow Range	75°
Size [mm]	0.5" [15]
End Fitting	npt female ends
Body	forged brass, nickel plated
Ball	chrome plated brass
Stem	nickel plated brass
Stem Packing	EPDM (lubricated)
Seat	Teflon® PTFE
Seat O-ring	EPDM (lubricated)
Characterized Disc	TEFZEL®
Body Pressure Rating [psi]	600
Media Temperature Range (Water)	0°F to 250°F [-18°C to 120°C]
Max Differential Pressure (Water)	50 psi (345 kPa)
Close-Off Pressure	200 psi
Cv	0.3
Weight	0.7 lb [0.3 kg]
Leakage	0% for A to AB, <2.0% for B to AB
Servicing	maintenance free

Application

This valve is typically used in air handling units on heating or cooling coils, and fan coil unit heating or cooling coils. Some other common applications include Unit Ventilators, VAV box re-heat coils and bypass loops. This valve is suitable for use in a hydronic system with variable or constant flow.

Suitable Actuators

	Non-Spring	Spring
B307B	TR, LR	TFR, LF

Dimensions (Inches [mm])



A	B	C	D	E	F	H1	H2
8.5" [216]	2.38" [60]	5.19" [132]	4.61" [117]	1.3" [33]		1.18" [30]	1.1" [28]

Flow Pattern



Date created, 08/14/2017 - Subject to change. © Belimo Aircontrols (USA), Inc.

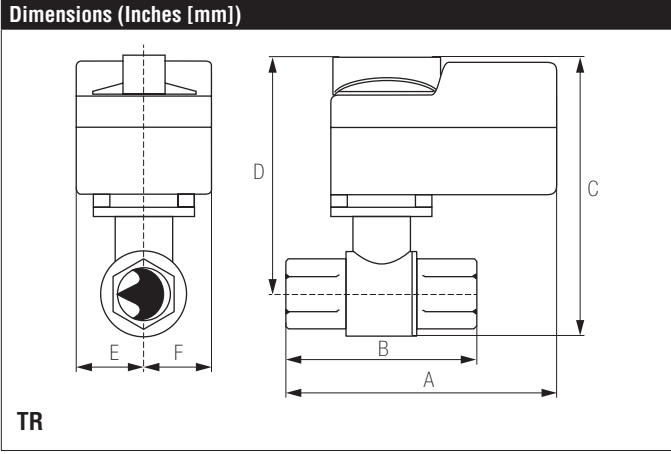

A	B	C	D	E	F
3.72" [95]	2.38" [60]	4.79" [122]	4.21" [107]	1.25" [32]	1.2" [31]

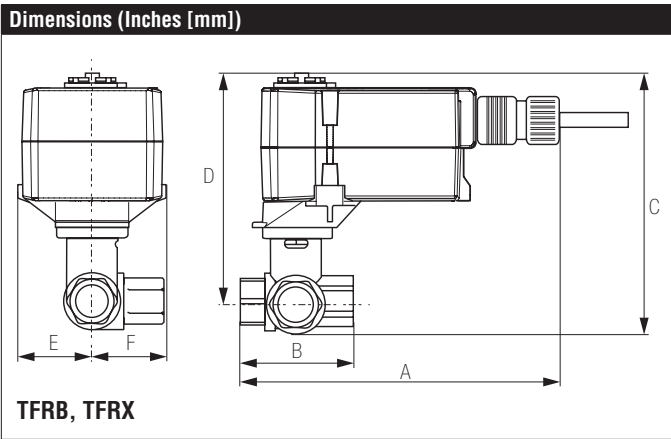

A	B	C	D	E	F
6.59" [167]	2.38" [60]	4.9" [124]	4.32" [110]	1.53" [38]	1.2" [31]



A	B	C	D	E	F
7.92" [201]	2.38" [60]	5.67" [144]	5.09" [129]	1.82" [46]	1.89" [48]

TR24-SR/300 US

Modulating, Non-Spring Return, 24 V, for 2 to 10 VDC or 4 to 20 mA



Technical Data	
Power Supply	24 VAC \pm 20%, 50/60 Hz, 24 VDC \pm 10%
Power Consumption Running	0.5 W
Transformer Sizing	1 VA (class 2 power source)
Electrical Connection	10ft [3m], 18 GA plenum rated cable
Overload Protection	electronic throughout full rotation
Operating Range Y	2 to 10 VDC, 4 to 20 mA w/ ZG-R01 (500 Ω , 1/4 W resistor)
Input Impedance	100 k Ω for 2 to 10 VDC (0.1 mA), 500 Ω for 4 to 20 mA
Angle of Rotation	90°
Direction of Rotation (Motor)	reversible with protected switch
Position Indication	integrated into handle
Manual Override	push down handle
Running Time (Motor)	90 sec
Ambient Temperature Range	-22°F to 122°F [-30°C to 50°C]
Storage Temperature Range	-40°F to 176°F [-40°C to 80°C]
Housing	NEMA type 1 / IP40
Agency Listings†	cULus acc. to UL60730-1A/-2-14, CAN/CSA E60730-1:02, CE acc. to 2004/108/EC and 2006/95/EC
Noise Level (Motor)	<35 dB (A)
Servicing	maintenance free
Quality Standard	ISO 9001

Date created, 08/14/2017 - Subject to change. © Belimo Aircontrols (USA), Inc.

Wiring Diagrams
INSTALLATION NOTES

- Provide overload protection and disconnect as required.
- Actuators may also be powered by 24 VDC.
- Only connect common to negative (-) leg of control circuits.
- A 500 Ω resistor (ZG-R01) converts the 4 to 20 mA control signal to 2 to 10 VDC.
- Actuators may be connected in parallel if not mechanically linked. Power consumption and input impedance must be observed.
- Meets cULus requirements without the need of an electrical ground connection.

WARNING! LIVE ELECTRICAL COMPONENTS!
 During installation, testing, servicing and troubleshooting of this product, it may be necessary to work with live electrical components. Have a qualified licensed electrician or other individual who has been properly trained in handling live electrical components perform these tasks. Failure to follow all electrical safety precautions when exposed to live electrical components could result in death or serious injury.

