

# B312, 3-Way, Characterized Control Valve

## Stainless Steel Ball and Stem



Technical Data	
Service	chilled, hot water, up to 60% glycol
Flow Characteristic	A-port equal percentage, B-port modified for constant common port flow
Controllable Flow Range	75°
Size [mm]	0.5" [15]
End Fitting	NPT female ends
Body	forged brass, nickel plated
Ball	stainless steel
Stem	stainless steel
Stem Packing	EPDM (lubricated)
Seat	Teflon® PTFE
Seat O-ring	EPDM (lubricated)
Characterized Disc	TEFZEL®
Body Pressure Rating [psi]	600
Media Temperature Range (Water)	0°F to 250°F [-18°C to 120°C]
Max Differential Pressure (Water)	50 psi (345 kPa)
Close-Off Pressure	200 psi
Cv	3
Weight	0.7 lb [0.3 kg]
Leakage	0% for A to AB, <2.0% for B to AB
Servicing	maintenance free

### Application

This valve is typically used in air handling units on heating or cooling coils, and fan coil unit heating or cooling coils. Some other common applications include Unit Ventilators, VAV box re-heat coils and bypass loops. This valve is suitable for use in a hydronic system with variable or constant flow.

### Suitable Actuators

	Non-Spring	Spring
B312	TR, LR, NRB(X)	TFB(X), LF

### Dimensions (Inches [mm])



A	B	C	D	E	F	H1	H2
8.5" [216]	2.4" [61]	5.19" [132]	5" [127]	1.3" [33]		1.18" [30]	1.1" [28]

### Flow Pattern

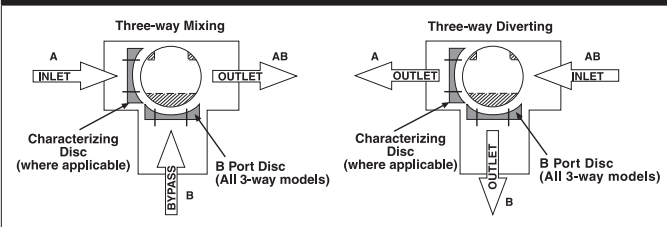

Date created, 10/27/2017 - Subject to change. © Belimo Aircontrols (USA), Inc.

# B312, 3-Way, Characterized Control Valve

## Stainless Steel Ball and Stem

### Dimensions (Inches [mm])



A	B	C	D	E	F	H1	H2
8.9"	2.4"	5.74"	5.16"	1.58"	[40]	1.18"	1.3"
[226]	[61]	[146]	[131]			[30]	[33]

### Dimensions (Inches [mm])



A	B	C	D	E	F
7.9"	2.4"	5.67"	5.09"	1.82"	[46]
[201]	[61]	[144]	[129]		

### Dimensions (Inches [mm])



A	B	C	D	E	F
3.72"	2.4"	4.79"	4.21"	1.25"	[31]
[95]	[61]	[122]	[107]	[32]	

### Dimensions (Inches [mm])

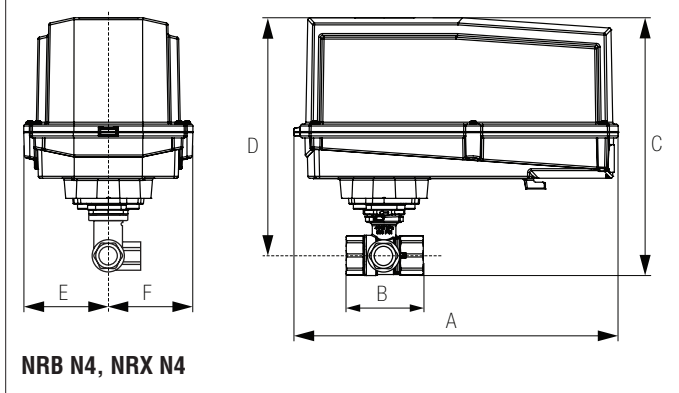

A	B	C	D	E	F
11.36"	2.4"	7.25"	6.67"	3.15"	[80]
[289]	[61]	[184]	[169]		

### Dimensions (Inches [mm])



A	B	C	D	E	F
6.59"	2.4"	4.9"	4.32"	1.53"	[38]
[167]	[61]	[124]	[110]	[38]	

# TFRB120

## On/Off, Spring Return, 100 to 240 VAC







Technical Data	
Power Supply	100...240 VAC, -15% / +10%, 50/60 Hz
Power Consumption Running	2.5 W
Power Consumption Holding	1.3 W
Transformer Sizing	5 VA (class 2 power source)
Electrical Connection	3ft [1m], 18 GA appliance cable with 1/2" conduit connector
Overload Protection	electronic throughout 0° to 95° rotation
Operating Range Y	on/off
Feedback Output U	No Feedback
Angle of Rotation	Max. 95°, 90°
Direction of Rotation (Motor)	reversible with CW/CCW mounting
Direction of Rotation (Fail-Safe)	reversible with CW/CCW mounting
Position Indication	visual indicator, 0° to 95° (0° is full spring return position)
Running Time (Motor)	<75 sec
Running Time (Fail-Safe)	<75 sec
Ambient Humidity	max. 95% RH non-condensing
Ambient Temperature Range	-22°F to 122°F [-30°C to 50°C]
Storage Temperature Range	-40°F to 176°F [-40°C to 80°C]
Housing	NEMA 2, IP42, UL Enclosure Type 2
Housing Material	UL94-5VA
Agency Listings†	cULus acc. to UL60730-1A/-2-14, CAN/CSA E60730-1:02, CE acc. to 2004/108/EC
Noise Level (Motor)	<50 dB (A)
Noise Level (Fail-Safe)	<63 dB (A)
Servicing	maintenance free
Quality Standard	ISO 9001
Weight	1.8 lb [0.8 kg]

†Rated Impulse Voltage 800V, Type of action 1.AA, Control Pollution Degree 3

**Wiring Diagrams**

**✂ INSTALLATION NOTES**

-  Actuators with appliance cables are numbered.
-  Provide overload protection and disconnect as required.
-  Actuators may be connected in parallel. Power consumption and input impedance must be observed.
-  Meets cULus requirements without the need of an electrical ground connection.

** WARNING! LIVE ELECTRICAL COMPONENTS!**  
During installation, testing, servicing and troubleshooting of this product, it may be necessary to work with live electrical components. Have a qualified licensed electrician or other individual who has been properly trained in handling live electrical components perform these tasks. Failure to follow all electrical safety precautions when exposed to live electrical components could result in death or serious injury.

