

B348, 3-Way, Characterized Control Valve

Stainless Steel Ball and Stem



| Technical Data | |
|-----------------------------------|------------------------------------------------------------------------|
| Service | chilled, hot water, up to 60% glycol |
| Flow Characteristic | A-port equal percentage, B-port modified for constant common port flow |
| Controllable Flow Range | 75° |
| Size [mm] | 2" [50] |
| End Fitting | NPT female ends |
| Body | forged brass, nickel plated |
| Ball | stainless steel |
| Stem | stainless steel |
| Stem Packing | EPDM (lubricated) |
| Seat | Teflon® PTFE |
| Seat O-ring | EPDM (lubricated) |
| Characterized Disc | TEFZEL® |
| Body Pressure Rating [psi] | 400 |
| Media Temperature Range (Water) | 0°F to 250°F [-18°C to 120°C] |
| Max Differential Pressure (Water) | 50 psi (345 kPa) |
| Close-Off Pressure | 200 psi |
| Cv | 37 |
| Weight | 5.5 lb [2.5 kg] |
| Leakage | 0% for A to AB, <2.0% for B to AB |
| Servicing | maintenance free |

Application

This valve is typically used in air handling units on heating or cooling coils, and fan coil unit heating or cooling coils. Some other common applications include Unit Ventilators, VAV box re-heat coils and bypass loops. This valve is suitable for use in a hydronic system with variable or constant flow.

Suitable Actuators

| | Non-Spring | Spring |
|------|------------|--------|
| B348 | ARB(X) | AFB(X) |

Dimensions (Inches [mm])

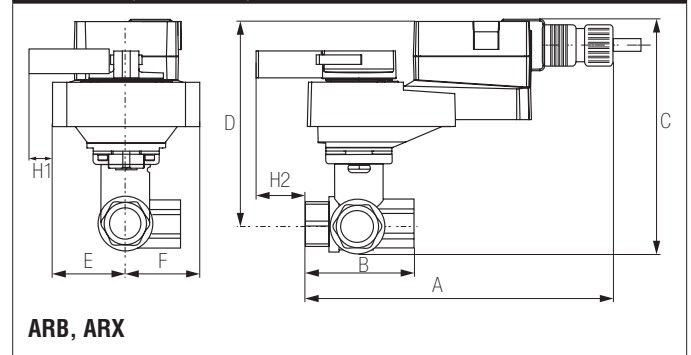

| A | B | C | D | E | F | H1 |
|----------------|------------------|----------------|----------------|------------|-----------|------------|
| 10.5" [267] | 4.90" [124.5] | 7.73" [196] | 5.98" [152] | 1.73" [44] | 2.6" [66] | 0.75" [20] |

Flow Pattern



Date created, 01/26/2018 - Subject to change. © Belimo Aircontrols (USA), Inc.

Dimensions (Inches [mm])



NRB N4, NRX N4

| A | B | C | D | E | F |
|-----------------|------------------|-------------|-------------|------------|---|
| 11.36" [289] | 4.90" [124.5] | 9.76" [248] | 8.01" [203] | 3.15" [80] | |

Dimensions (Inches [mm])



ARQB, ARQX

| A | B | C | D | E | F | H1 | H2 |
|---------------|------------------|----------------|----------------|---------------|--------------|---------------|-----------|
| 9.9" [251] | 4.90" [124.5] | 8.32" [211] | 6.57" [167] | 2.28" [58] | 2.6" [66] | 0.75" [20] | 0.5" [15] |

Dimensions (Inches [mm])



AFRB, AFRX

| A | B | C | D | E | F |
|-----------------|------------------|-------------|-------------|-----------|---|
| 11.27" [286] | 4.90" [124.5] | 8.36" [212] | 6.61" [168] | 2.6" [66] | |

AFRX24

On/Off, Spring Return Fail-Safe, 24 VAC







| Technical Data | |
|-----------------------------------|--------------------------------------------------------------------------------------------|
| Power Supply | 24 VAC ± 20%, 50/60 Hz, 24 VDC ± 10% |
| Power Consumption Running | 5 W |
| Power Consumption Holding | 2.5 W |
| Transformer Sizing | 7.5 VA (class 2 power source) |
| Electrical Connection | 3ft [1m], 18 GA appliance cable with 1/2" conduit connector |
| Overload Protection | electronic throughout 0° to 95° rotation |
| Operating Range Y | on/off |
| Angle of Rotation | 90° |
| Direction of Rotation (Motor) | reversible with CW/CCW mounting |
| Direction of Rotation (Fail-Safe) | reversible with CW/CCW mounting |
| Position Indication | visual indicator, 0° to 95° (0° is full spring return position) |
| Manual Override | 5 mm hex crank (3/16" Allen), supplied |
| Running Time (Motor) | <75 sec |
| Running Time (Fail-Safe) | <20 sec |
| Ambient Temperature Range | -22°F to 122°F [-30°C to 50°C] |
| Storage Temperature Range | -40°F to 176°F [-40°C to 80°C] |
| Housing | NEMA 2, IP54, UL enclosure type 2 |
| Agency Listings† | cULus acc. to UL60730-1A/-2-14, CAN/CSA E60730-1-02, CE acc. to 2004/108/EC and 2006/95/EC |
| Noise Level (Motor) | <45 dB (A) |
| Noise Level (Fail-Safe) | <62 dB (A) |
| Servicing | maintenance free |
| Quality Standard | ISO 9001 |

†Rated Impulse Voltage 800V, Type of action 1.AA, Control Pollution Degree 3

Date created, 08/14/2017 - Subject to change. © Belimo Aircontrols (USA), Inc.

Wiring Diagrams

✂ INSTALLATION NOTES

-  Actuators with appliance cables are numbered.
-  Provide overload protection and disconnect as required.
-  Actuators may also be powered by 24 VDC.
-  Actuators may be powered in parallel. Power consumption must be observed.
-  Parallel wiring required for piggy-back applications.

 Meets cULus requirements without the need of an electrical ground connection.

 **WARNING! LIVE ELECTRICAL COMPONENTS!**
 During installation, testing, servicing and troubleshooting of this product, it may be necessary to work with live electrical components. Have a qualified licensed electrician or other individual who has been properly trained in handling live electrical components perform these tasks. Failure to follow all electrical safety precautions when exposed to live electrical components could result in death or serious injury.

