

# UFLK1444 Retrofit Linkage for Centerline Butterfly Valves

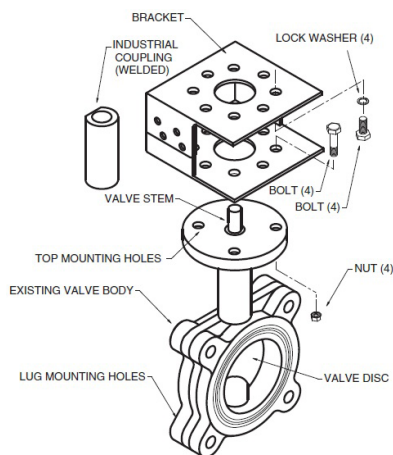

Technical Data	
Applicable Valve Size	6" [150]
Hardware	zinc plated steel
Frame, plate, base	stainless steel
Shaft	stainless steel
Coupling	steel
Mounting Position	360°
Weight	17 lb [7.3 kg]

For close-off pressure reference Select Pro or Retrofit Technical Documentation.

## Application

The UFLK retrofit kit is designed to easily attach to the valve mounting pad on select competitor valves utilizing Belimo SY industrial series actuators. This kit will help to restore service without removal of the valve, saving down time. The UFLK retrofit kits are available in various configurations for use with both 2-way and 3-way valves where applicable.

## Operation

The UFLK and mounted actuator(s) are capable of rotating 90° in both CW and CCW directions. This allows the disc to fully open or close. When directional needs vary, the actuator's directional switch can be flipped to change the rotation. The SY/PR is NEMA 4X rated and can be used outdoors.

## Default/Configuration

The actuator is sold separately from the linkage. This allows users to select the specified actuator with the desired control signal. Since the linkage utilizes standard SY actuators, they can be purchased at any time and mounted in the field.

## Suitable Actuators

	Non-Spring
UFLK1444	SY4

## Dimensions (Inches [mm])

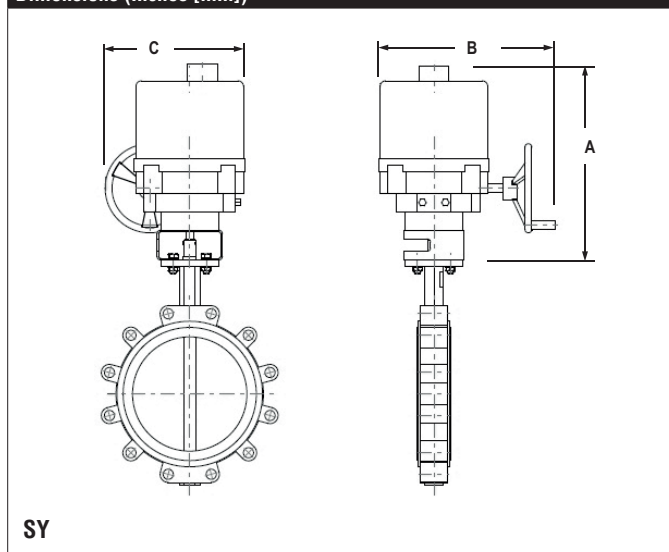

A	B	C
25.2" [640]	15.01" [381.2]	11.8" [300]