

UFLK1709 Retrofit Linkage for Flowseal Butterfly Valves

For Use with Belimo Rotary Actuators

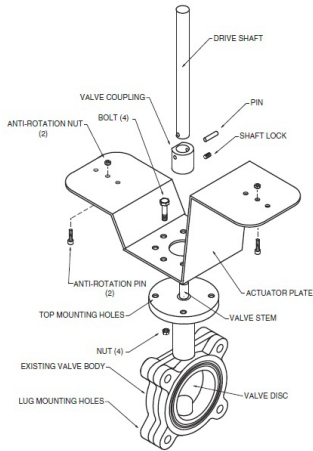

Technical Data	
Applicable Valve Size	3" [80], 4" [100]
Hardware	zinc plated steel
Frame, plate, base	stainless steel
Shaft	stainless steel
Coupling	stainless steel
Mounting Position	360°
Weight	6.0 lb [2.8 kg]

For close-off pressure reference Select Pro or Retrofit Technical Documentation.

Application

The UFLK/UBLK retrofit kit is designed to easily attach to the valve mounting pad on select competitor butterfly valves utilizing Belimo actuators. This kit will help to restore service without removal of the valve, saving down time. The retrofit kit is available in various configurations for use with both 2-way and 3-way valves utilizing single or dual actuation where applicable.

Operation

The UFLK/UBLK kit and mounted actuator(s) are capable of rotating 95° in both CW and CCW directions. This allows the disc/ball to fully open or close. When directional needs vary, the actuators can be flipped or directional switch turned to a new rotation. Refer to the actuator wiring guides on Master/Slave wiring for dual mounted actuators.

Default/Configuration

The actuator is sold separately from the linkage. This allows users to select any actuator with the desired control signal. Since the linkage utilizes standard airside actuators, they can be purchased at any time and mounted in the field.

Suitable Actuators

	Non-Spring	Spring	US only
UFLK1709	2*GMB(X)	2*AFB(X)	2*GKB(X)

Dimensions (Inches [mm])

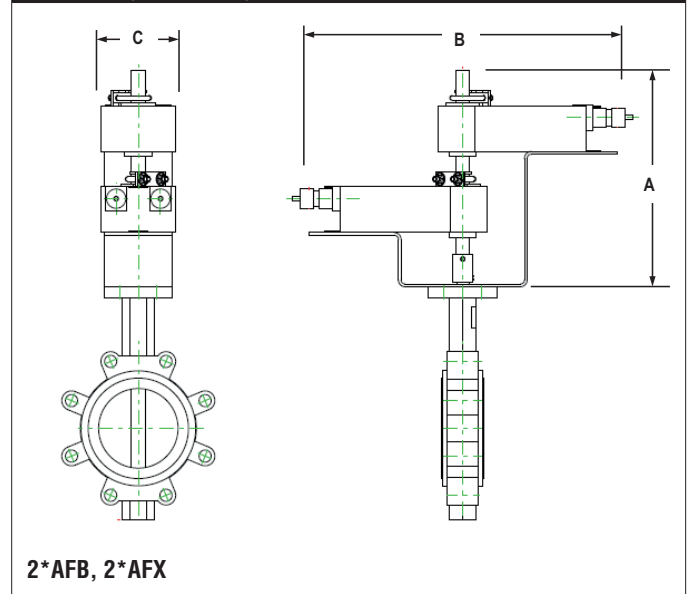

A	B	C
11.50" [292.1]	16.13" [410]	4.5" [114.3]

Date created, 09/26/2018 - Subject to change. © Belimo Aircontrols (USA), Inc.

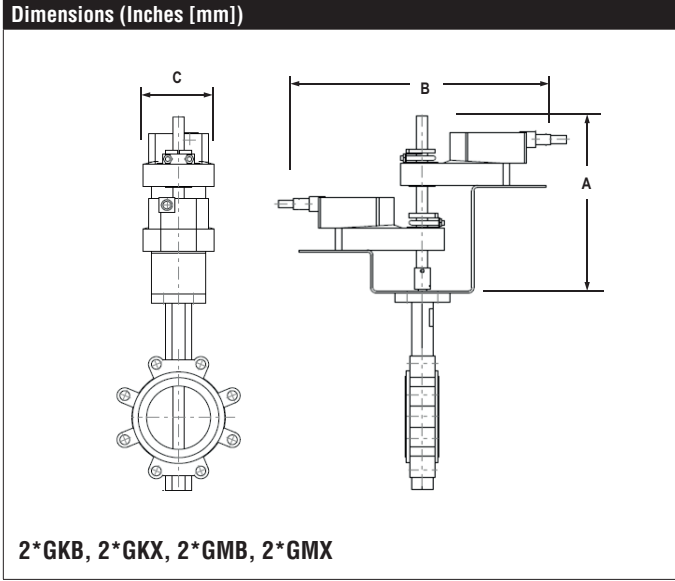

A	B	C
11.50" [292.1]	16.13" [410]	4.5" [114.3]