

ZONE220S-35, 3/4", Electronic Zone Valve



Technical Data	
Service	chilled or hot water, up to 50% glycol
Flow Characteristic	on/off
Size [mm]	0.75" [20]
End Fitting	sweat
Body	forged brass
Body Seal	EPDM
Stem	stainless steel
Seat	EPDM
Body Pressure Rating [psi]	300
Media Temperature Range (Water)	32°F to 212°F [0°C to 100°C]
Close-Off Pressure	30 psi
Cv	3.5
Weight	0.7 lb [0.3 kg]
Leakage	ANSI Class III 0.1%

Application

This valve is typically used on fan coil units, baseboards or other hydronic applications where fail safe operation on 2-wire control is required. This valve is suitable for use in a hydronic system with variable or constant flow.

This valve is designed to fit in compact areas where on/off or control is required using 24 VAC or 120 VAC.

Suitable Actuators

	Spring
ZONE220S-35	ZONE

Dimensions (Inches [mm])

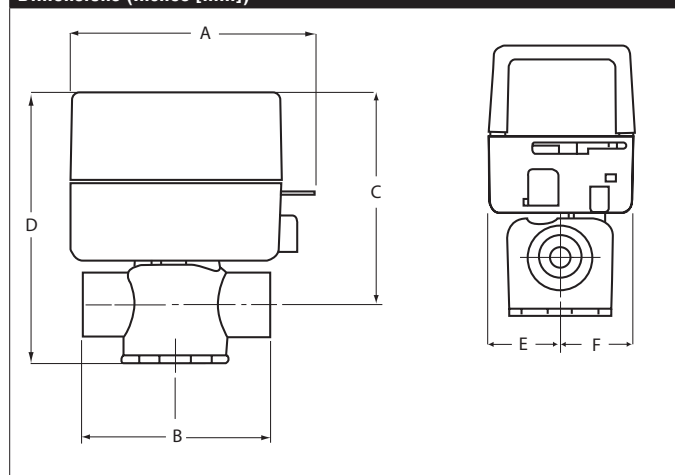

A	B	C	D	E	F
4" [102]	2.83" [72]	3.5" [89]	4.45" [113]	1.18" [30]	

ZONE230NO-S



Technical Data	
Power Supply	230 VAC \pm 10%, 50/60 Hz
Power Consumption Running	6.5 W
Transformer Sizing	7 VA (class 2 power source)
Electrical Connection	6" wire leads
Running Time (Motor)	20 to 40 sec
Humidity	5 to 95% RH non-condensing
Ambient Temperature Range	32°F to 104°F [0°C to 40°C]
Storage Temperature Range	-40°F to 176°F [-40°C to 80°C]
Housing	NEMA type 1 / IP20
Housing Material	UL94-5VB
Agency Listings†	CE, cULus
Noise Level (Motor)	<35 dB (A)
Servicing	maintenance free
Quality Standard	ISO 9001

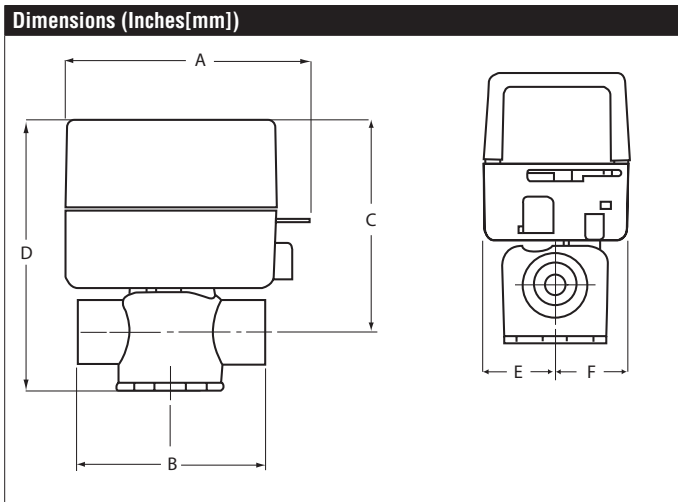

Wiring Diagrams

INSTALLATION NOTES



Meets cULus requirements without the need of an electrical ground connection.



One built-in auxiliary switch, 1x SPST 0.4A @ 24 VAC (resistive and inductive loads).

