

ZONE315S-35, 1/2", Electronic Zone Valve



Technical Data	
Service	chilled or hot water, up to 50% glycol
Flow Characteristic	on/off, diverting
Size [mm]	0.5" [15]
End Fitting	sweat
Body	forged brass
Body Seal	EPDM
Stem	stainless steel
Seat	EPDM
Body Pressure Rating [psi]	300
Media Temperature Range (Water)	32°F to 212°F [0°C to 100°C]
Close-Off Pressure	30 psi
Cv	3.5
Weight	0.9 lb [0.4 kg]
Leakage	ANSI Class III 0.1%

Application

This valve is typically used on fan coil units, baseboards or other hydronic applications where fail safe operation on 2-wire control is required. This valve is suitable for use in a hydronic system with variable or constant flow.

This valve is designed to fit in compact areas where on/off or control is required using 24 VAC or 120 VAC.

Suitable Actuators

	Spring
ZONE315S-35	ZONE

Dimensions (Inches [mm])



A	B	C	D	E	F
4" [102]	2.75" [70]	3.5" [89]	4.76" [121]	1.18" [30]	

ZONE24NC-S



Technical Data	
Power Supply	24 VAC ± 10%, 50/60 Hz
Power Consumption Running	6.5 W
Transformer Sizing	7 VA (class 2 power source)
Electrical Connection	18" wire leads
Angle of Rotation	90°
Position Indication	integrated into lever (NC only)
Manual Override	manual lever
Running Time (Motor)	20 to 40 sec
Running Time (Fail-Safe)	5 sec (default), variable 2.5 to 10 sec
Humidity	5 to 95% RH non-condensing
Ambient Temperature Range	32°F to 104°F [0°C to 40°C]
Storage Temperature Range	-40°F to 176°F [-40°C to 80°C]
Housing	NEMA type 1 / IP20
Housing Material	UL94-5VB
Agency Listings†	CE, cULus
Noise Level (Motor)	<35 dB (A)
Servicing	maintenance free
Quality Standard	ISO 9001
Weight	0.9 lb [0.4 kg]
Auxiliary Switch	1 x SPST, .4A resistive (.4A inductive) @ 24 VAC

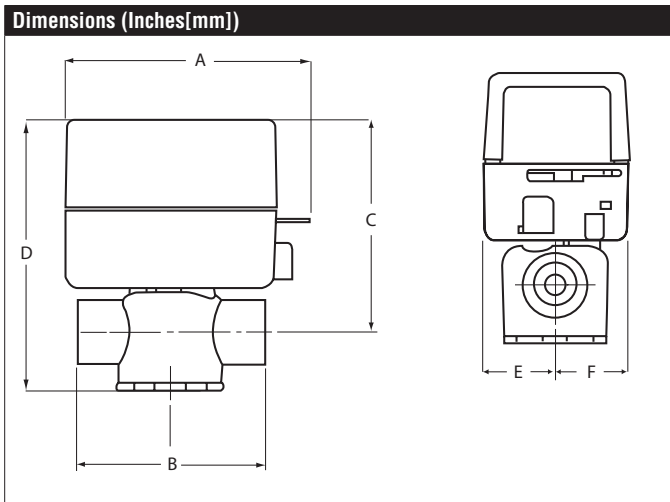

Wiring Diagrams**INSTALLATION NOTES**

Meets cULus requirements without the need of an electrical ground connection.



One built-in auxiliary switch, 1x SPST 0.4A @ 24 VAC (resistive and inductive loads).

