

TR20VA007

TRANSFORMER

Transformer 20 VA, 277 to 24 Vac, Foot and Single Threaded Hub Mount



SPECIFICATIONS

- VA Rating:** 20
- Frequency:** 50/60 Hz
- Mounting:** Foot & Single Threaded Hub
- Over Current Protection:** Inherently Limited
- Dimensions:** 2.600" x 1.900" x 2.125"
(w/ .500" NPT Hub)
- Wire Length:** 8" Typical w/ .5" Strip
- Operating Temperature:** -30 to 140° F
- MTBF:** 100,000 Hours @ 77° F
- Construction:** Split-Bobbin
- Weight:** 1.38 lbs.
- Approvals:** Class II UL1585 Listed, C-UL, CE, RoHS

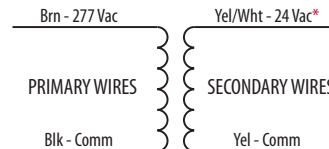
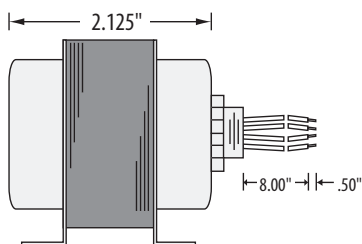
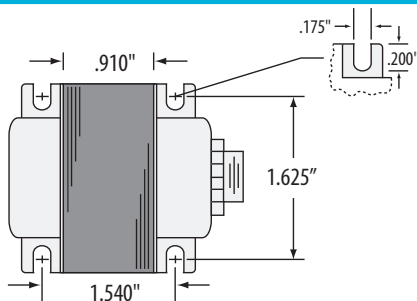

*Secondary Yel/Wht wire in phase with Primary Blk wire.

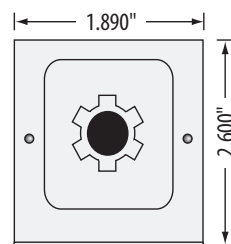

NOTES