

T775P Series 2000 Electronic Stand-Alone Controller

INSTALLATION INSTRUCTIONS



PRODUCT DESCRIPTION

The T775 electronic stand-alone controllers are the next generation of commercial and agricultural controls capable of remote sensing of temperature and providing switched and/or proportional outputs to various types of loads. A built-in time clock is standard.

The T775P can be configured with or without Reset control from a single heat or cool setpoint.

Three sensors are configurable. In normal installations, Sensor A is the supply controlled temperature, Sensor B is the outdoor controlling (reset) temperature, and Sensor C is the return controlled temperature, which can be used for the Differential alarm and/or as the controlled setpoint sensor.

The T775P can be configured with up to two T775S Expansion Modules for a maximum of up to 12 stages with the last stage being an option for a pump stage.

IMPORTANT

The T775P is an operating control, not a limit or safety control. If used in applications requiring safety or limit controls, a separate safety or limit control device is required.

Table 1. T775P Controller Configuration.

Controller Model	Description	Output Reset	SPDT Relay Outputs	Digital Output	Digital Input	Sensor Inputs	Number of Sensors Included	Stage Control	Addable T775S	Enclosure
T775P2003 ^a	Boiler Model with Reset	Yes	4 ^b	1	1 ^c	3	3	Yes	Yes	NEMA 1

^a The T775P model can be used to stage multiple relays from a single heat or cool setpoint. The number of stages can be freely chosen, limited by the number of relays available (up to 12 stages [11 if using the pump output] using two T775S expansion modules).

^b The T775P provides a pump output using the last of the four SPDT relay outputs on the T775P controller. When T775S Expansion Modules are used, the configurable pump output is the last relay output of the last expansion module. The pump output will be either stage 4, 8, or 12, depending on whether T775S Expansion module(s) are used.

^c The T775P includes a digital input for use with the disable or setback option.



Temperature Sensors

The controller accepts 1,097 Ohms PTC at 77°F (25°C):

- 50021579-001 – Standard sensor (included with all models except NEMA 4X models)
- T775-SENS-WR – Water resistant with 5 foot leads (included with NEMA 4X models)
- T775-SENS-WT – Watertight with 6 foot lead
- T775-SENS-OAT – Outdoor air temperature sensor
- C7031D2003 – 5 inch immersion sensor with wiring box (use immersion well; P/N 50001774-001)
- C7031J2009 – 12 foot duct averaging sensor with wiring box
- C7046D1008 – 8 inch duct probe with mounting flange
- C7100D1001 – 12 inch fast response, duct averaging sensor with flange
- C7130B1009 – Room mount sensor

Accessories

- 107324A – Bulb Holder, duct insertion
- 107408 – Heat Conductive Compound, 4 ounce
- 50001774-001 – Immersion Well, stainless steel 304, 1/2 in. threading

Controller Dimensions

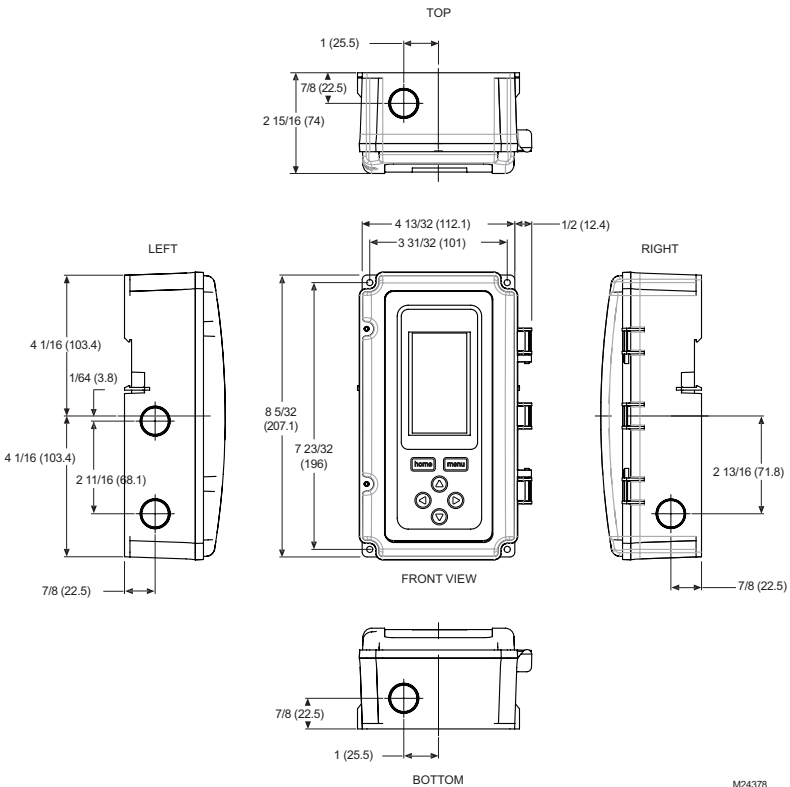

M24378

Fig. 1. T775P Dimensions in inches (mm).

BEFORE INSTALLATION

Review the “Specifications” on page 36 before installing the controller.

When Installing This Product

1. Read these instructions carefully. Failure to follow them could damage the product or cause a hazardous condition.
2. Check ratings given in instructions and on the product to ensure the product is suitable for your application.
3. Installer must be a trained, experienced service technician.
4. After installation is complete, check out product operation as provided in these instructions.

INSTALLATION AND SETUP

The following installation procedures are typically performed in the order listed:

1. Mounting — see “Mounting” below.
2. Wiring — see “Wiring” on this page.
3. Checkout — see page 8.
4. Interface and Programming overview – see page 9.
5. Setup – see page 12.
6. Programming the Controller with no Reset – see page 26 or
Programming the Controller with Reset – page 29.
7. Scheduling (optional) — see page 31.

Additional topics are:

- Temperature sensor calibration begins on page 8.
- Interface overview begins on page 9.
- Summary menu begins on page 35.
- Troubleshooting begins on page 35.

MOUNTING

This section describes the mounting procedures for the controller and temperature sensor(s).

Controller Mounting

IMPORTANT

Avoid mounting in areas where acid fumes or other deteriorating vapors can attack the metal parts of the controller circuit board, or in areas where escaping gas or other explosive vapors are present.

IMPORTANT

The controller must be mounted in a position that allows clearance for wiring, servicing, and removal.

Use a screwdriver to pop out only the knockouts that you will use.

If mounting on DIN rail, be sure to remove the knockouts before mounting. See “Controller Wiring” on page 5 and Fig. 7 on page 6 for recommended knockout usage and locations. If you do not use an opened knockout be sure to cover it.

Mount the controller on any convenient interior location using the four mounting holes provided on the back of the enclosure using #6 or #8 screws (screws are not provided and must be obtained separately). Use controller dimensions in Fig. 1 on page 2 as a guide.

The controller may be mounted in any orientation. However, mounting in the orientation shown in Fig. 1 permits proper viewing of the LCD display and use of the keypad.

Temperature Sensor(s) Mounting and Location

Temperature sensors may be located up to 1,000 feet (304 m) from the T775P controller. See Table 3 on page 8 for calibration guidelines.

The sensors may be mounted on a wall or panel for sensing space temperature, strapped to a pipe or inserted in an immersion well (see Fig. 2) for hot or cold water sensing, or taped to a standard cap or bulb holder for duct air sensing. To prevent moisture or condensation entering the sensor through the lead wire holes, mount the sensor with the lead wires exiting the bottom of the sensor.

NOTES:

1. The included sensor is not designed for very wet applications. For immersion applications, an immersion well is used.
2. Heat conductive compound must be used in immersion wells.
3. See “Temperature Sensors” on page 2 for this type of installation.

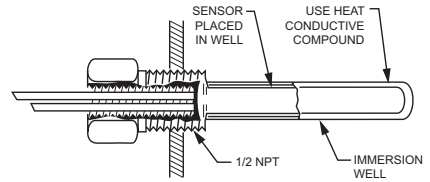

M24388

Fig. 2. Sensor inserted in immersion well.

NOTE: Multiple sensors may be parallel-series wired to sense average temperatures in large spaces. See Fig. 3 on page 4.

WIRING

All wiring must comply with applicable electrical codes and ordinances, or as specified on installation wiring diagrams. Controller wiring is terminated to the screw terminal blocks located inside the device.

The remainder of this section describes the temperature sensor wiring and the T775P controller wiring.

Wiring Connections Access

To access the wiring connections, remove the two screws on the left side of the enclosure and gently swing open the top. Be careful to not stress the ribbon cables that connect the keypad and LCD display to the controller circuit board.

Temperature Sensor Wiring

⚠ CAUTION

Electrical Shock Hazard.
Can short equipment circuitry.
 Make sure that metal tube of sensor does not short against T terminals in wall-mounted case.

IMPORTANT

Poor wiring practices can cause erratic readings from the sensor. Avoid the following to ensure proper operation:

- Do not route the temperature sensor wiring with building power wiring.
- Do not locate the temperature sensor wiring next to control contactors.
- Do not locate the temperature sensor wiring near electrical motors.
- Do not locate the temperature sensor wiring near welding equipment.
- Make sure good mechanical connections are made to both the sensor and the controller.
- Do not mount the sensor with the lead wire end pointing up in an area where condensation can occur.

If any of the above conditions cannot be avoided, use shielded cable.

NOTE: Each temperature sensor must be wired to a single T775 controller. However, a benefit of the T775 controller's accuracy is that there is no more than a 2°F differential between any two T775 controllers.

Reset Temperature Control

If you are implementing two-sensor reset control, Sensor A or C must always be the controlled temperature and Sensor B must always be the controlling temperature.

For example, in a reset control based on outside temperature, Sensor A or C must be the inside sensor (supply, boiler, chiller, or return) and Sensor B must be the outside sensor.

Multiple Parallel Sensors

Multiple sensors can be parallel-series wired to sense average temperatures in large spaces. To maintain control accuracy, the number of sensors to be parallel-series wired must be of the n^2 power (for example, 4, 9, 16, etc.). See Fig. 3.

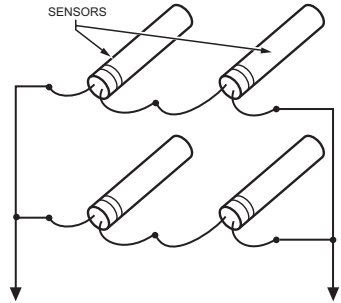

TO T775 CONNECTIONS (SENSOR A) OR (SENSOR B).

M24380

Fig. 3. Parallel-series wiring of sensors.

Temperature Sensor Wire Type and Size

Temperature sensors use standard AWG 18/2 unshielded wire. For cable runs greater than 25 feet or where electrical interference may be a problem, shielded cable is recommended. See Fig. 4.

Refer to "Temperature Sensor Calibration" on page 8 for wire size selection where cable runs are longer than 25 feet.

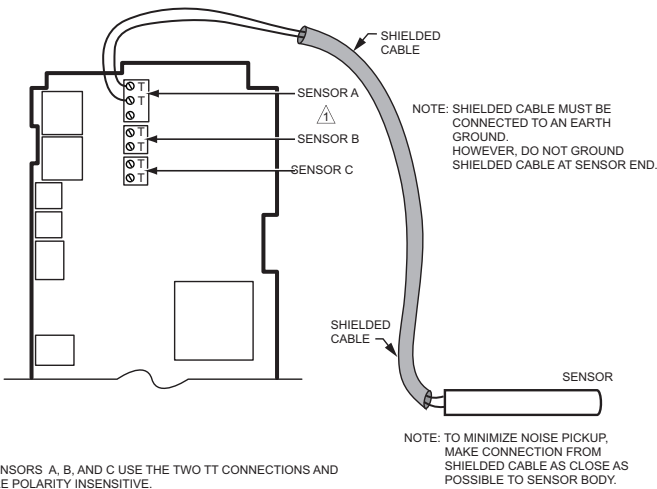

⚠ SENSORS A, B, AND C USE THE TWO TT CONNECTIONS AND ARE POLARITY INSENSITIVE.

M24374

Fig. 4. Sensor Wiring — Showing shielded cable connection to Sensor A.

Controller Wiring

! WARNING

Electrical Shock Hazard.
Can cause severe injury, death or property damage.

Disconnect power supply before beginning wiring, or making wiring connections, to prevent electrical shock or equipment damage.

! CAUTION

Do not use 24 Vac power to power any external loads if 120 Vac or 240 Vac is used to power the T775P.

! CAUTION

A separate earth ground is required. Equipment damage can result if the earth ground is not connected. See Fig. 7 and Table 2 on page 6.

! CAUTION

Equipment Damage Hazard. Electrostatic discharge can short equipment circuitry. Ensure that you are properly grounded before handling the unit.

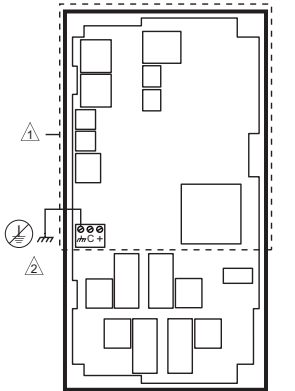

! NO HIGH VOLTAGE. CLASS 2 WIRING ONLY.
! EARTH GROUND TERMINAL MUST BE CONNECTED TO CONDUIT CLAMP LOCALLY.
M24296

Fig. 5. Earth Ground.

IMPORTANT

Poor wiring practices can cause erratic readings from the sensor. To ensure proper operation, ensure that good mechanical connections are made to both the sensor and the controller.

IMPORTANT

When wiring the input power, only one source of power can be applied to the T775P (24, 120, or 240 Vac).

See Fig. 7 on page 6 for locating the appropriate power input, remote sensors input, low voltage, contact closure, and load output terminals.

Access to the terminals can be gained through standard conduit knockouts (A through E in Fig. 7 on page 6) located around the perimeter of the enclosure:

- Knockouts A and B should be used only for sensor and low-voltage wiring.
- Knockouts C, D, and E can be used to gain access to the load relay output terminals and 120/240 Vac power wiring.

Controller Wiring Method

Wire the sensors and outputs, then wire the power connection.

Each terminal can accommodate the following gauges of wire:

- Single wire – from 14 AWG to 22 AWG solid or stranded
- Multiple wires – up to two 22 AWG stranded

For 24, 120, or 240 Vac power connections:

Single wire – from 14 to 18 AWG solid or stranded

Prepare wiring for the terminal blocks, as follows:

1. Strip 1/2 in. (13 mm) insulation from the conductor.
2. Cut a single wire to 3/16 in. (5 mm). Insert the wire in the required terminal location and tighten the screw.
3. If two or more wires are being inserted into one terminal location, twist the wires together a minimum of three turns before inserting them to ensure proper electrical contact.
4. Cut the twisted end of the wires to 3/16 in. (5 mm) before inserting them into the terminal and tightening the screw.
5. Pull on each wire in all terminals to check for good mechanical connection.

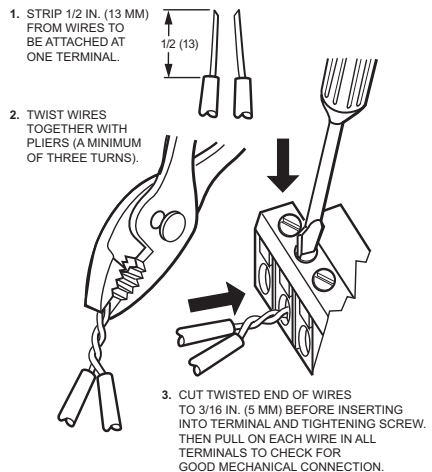

Fig. 6. Attaching two or more wires at terminal blocks.

M24382

Controller Wiring Details

The wiring connection terminals are shown in Fig. 7 and are described in Table 2.

See Fig. 8 – Fig. 12 beginning on page 7 for typical T775P wiring applications.

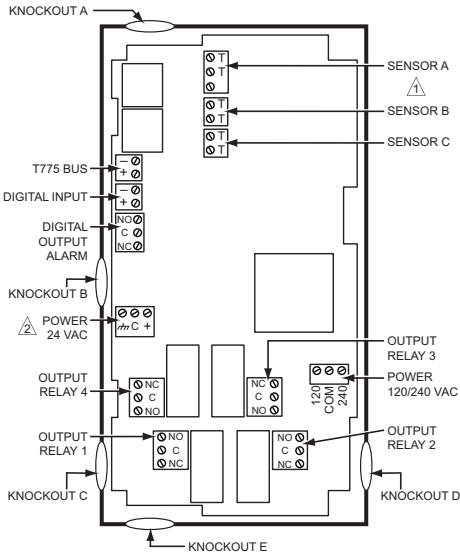

▲ SENSORS A, B, AND C (WHEN USED FOR TEMPERATURE SENSING) USE THE TWO TT CONNECTIONS AND ARE POLARITY INSENSITIVE.
 ▲ A SEPARATE EARTH GROUND IS REQUIRED FOR ANY POWER SOURCE (24, 120, OR 240 VAC).

M24375

Fig. 7. T775P Terminal and Feature Locations.

Table 2. Description of Wiring Terminal Connections.

Connection	Terminal	Description
Sensors		
Sensor A	T T	Temperature Sensor; polarity insensitive: A - This sensor can be the controlled temperature sensor
Sensor B	T T	B - The control always uses this sensor for Reset only
Sensor C	T T	C - This sensor can be used for differential and/or the controlled temperature sensor
Outputs		
Relay 1	NO COM NC	120-240 Vac Relay Output
Relay 2		
Relay 3		
Relay 4 ^a		
DO		Digital Alarm Output
Input		
DI	+ -	Digital Input (dry contact)
Interconnect		
T775 BUS	+ -	Terminal Connection to/from T775S
24 Vac Power		
24V +	+	24 Vac Hot
Common	-	24 Vac Common
Ground	⏏	Earth Ground ^b
120 or 240 Vac Power		
120 Vac	120	120 Vac Power
Common	COM	Common
240 Vac	240	240 Vac Power

^a Relay 4 can be used for pump output. The pump output is always the last relay output.

^b A separate earth ground is required for all installations regardless of the power source (24, 120, or 240 Vac).

NOTES:

- Relays 5–8 are assigned to the first T775S Expansion Module, if connected. Relays 9–12 are assigned to the second T775S, if connected.
- If Expansion Modules are used, the pump output is always the last relay output, 8 or 12 respectively.

WIRING APPLICATION EXAMPLES

Fig. 8 — 12 illustrate typical controller wiring for various applications.

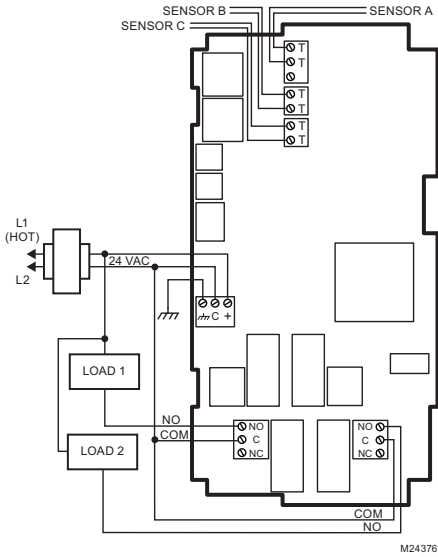

Fig. 8. Wiring for Two-stage Control – 24 Vac Input and 24 Vac Load.

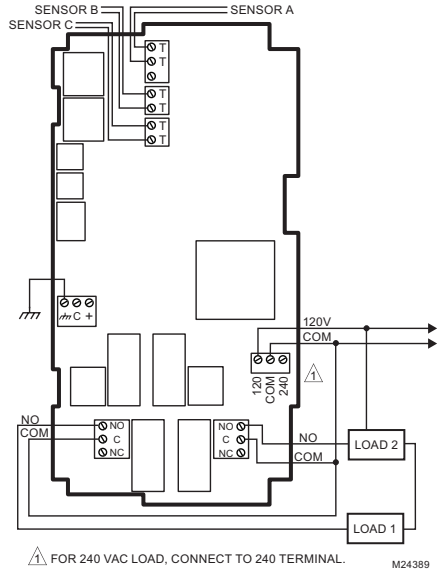

Fig. 10. Wiring for Two-stage Control with 120 or 240 Vac (120 Vac Input and 120 Vac Load shown).

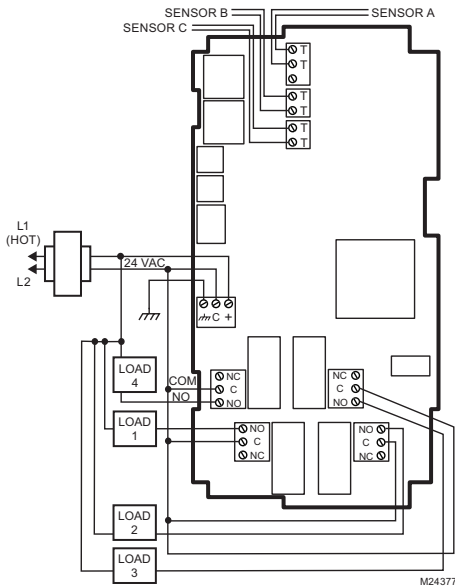

Fig. 9. Wiring for Four-stage Control – 24 Vac Input and 24 Vac Load.

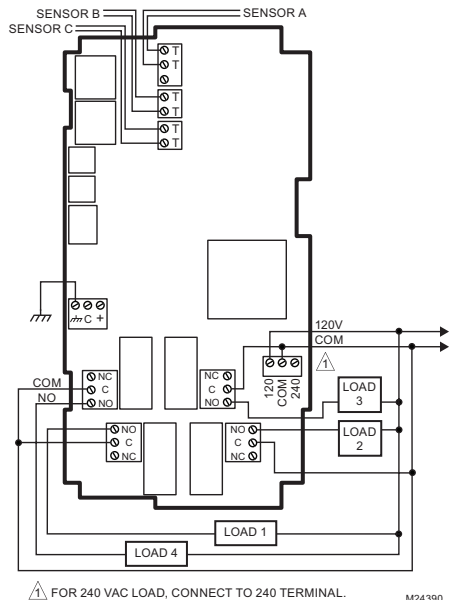

Fig. 11. Wiring for Four-stage Control with 120 or 240 Vac (120 Vac Input and 120 Vac Load shown).

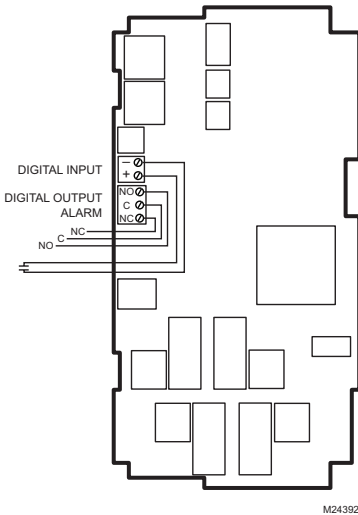

Fig. 12. Wiring for Digital Input (dry contact) and Digital Output.

IMPORTANT

If the calibration value in the table exceeds the controller's calibration limits of +/-10°F (+/-6°C), you must use a heavier gauge wire. For example, with a wire run of 1,000 feet you must use 20 AWG wire or heavier to calibrate for wire loss within the limits of the controller.

See "1.2.2.2. CALIBRATE (the sensor)" on page 14 for the instructions to enter the calibration value.

Table 3. Temperature Sensor Calibration for Resistance Loss due to Wire Length.

AWG Rating	mΩ/ft	Temperature Offset in °F (Foot) ^a		
		200 ft	500 ft	1,000 ft
14	2.5	0.46	1.14	2.28
16	4.0	0.72	1.82	3.64
18	6.4	1.16	2.90	5.82
20	10.2	1.86	4.64	9.28
22	16.1	2.92	7.32	14.64

AWG Rating	mΩ/m	Temperature Offset in °C (Meter) ^a		
		100 m	200 m	300 m
14	8.3	0.44	0.86	1.30
16	13.2	0.68	1.38	2.06
18	21.0	1.10	2.18	3.28
20	33.5	1.74	3.48	5.22
22	52.8	2.74	5.48	8.22

^a This is the distance from the controller to the sensor (already accounts for round trip distance).

Fig. 13 shows how sensor resistance varies with temperature for a sensor having a positive temperature coefficient (PTC) of 2.1 Ohms per degree F (3.85 Ohms per degree C).

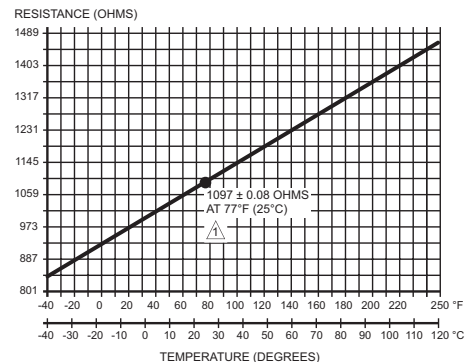

▲ POSITIVE TEMPERATURE COEFFICIENT (PTC) OF 2.1 OHMS PER °F
M24304

Fig. 13. Sensor Resistance vs. Temperature.

CHECKOUT

Inspect all wiring connections at the controller terminals, and verify compliance with the installation wiring diagrams.

⚠ WARNING

Electrical Shock Hazard.
Can cause severe injury, death or property damage.

Disconnect power supply before beginning wiring or making wiring connections, to prevent electrical shock or equipment damage.

If any wiring changes are required, *first* be sure to remove power from the controller *before* starting work. Pay particular attention to verifying the power connection (24, 120, or 240 Vac).

After the controller is mounted and wired, apply power.

Power Loss

The date and time settings are retained for 24 hours after a power outage. After a power loss of more than 24 hours, the date and time settings may need to be reentered. All other settings are stored permanently.

Temperature Sensor Calibration

As wire length increases, resistance increases and thus the temperature reading increases. If necessary, calibrate the sensor input by reducing the value by the amount shown in the Table 3. For example, a wire run with 18 gauge wire of 1,000 feet, requires a calibration offset of -6.0°F.

INTERFACE OVERVIEW

The T775P controller uses an LCD panel and 6-button keypad to provide status information and permit user input of the programming, setup, and scheduling parameters.

The following figure describes the display areas of the LCD and the keypad.

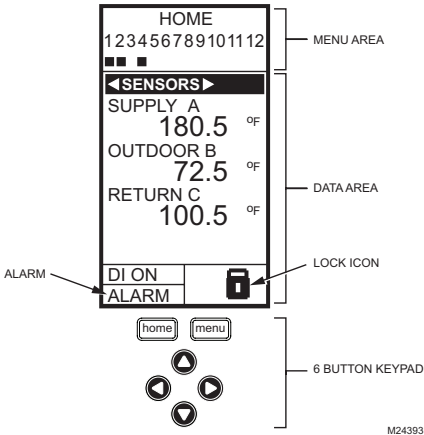

Fig. 14. LCD Display - Home Screen And Keypad.

Menu Area – On the home screen, the LCD displays the configured relays and whether they are active. In Program, Setup, or Schedule mode, the LCD displays the current menu selection and its order within the menu hierarchy.

Data Area – On the home screen, the LCD displays the sensors and outputs status. In Setup or Program mode, the LCD displays menu choices, parameter selections, and data values.

Lock Icon – The icon indicates the MENU button is locked and prevents access to the Setup and Program menus.

NOTE: Pressing and holding the HOME and MENU buttons simultaneously for five seconds locks/unlocks the MENU button.

Alarm – If enabled in Setup, this label displays when a limit is exceeded. The alarm label applies to either HIGH LIMIT, LOW LIMIT, or DIFFERENTIAL alarms.

6-Button Keypad – The keypad is used to access the menus and enter values (see “Using the LCD Panel Interface”).

Using the LCD Panel Interface

The 6-button keypad is used to move through the menus and enter or change parameter values.

Home Button

Pressing the HOME button at any time exits the current Programming or Setup display screen and returns to the home screen as shown in Fig. 14 and Fig. 15 on page 10.

Menu Button

1. Pressing the MENU button always displays the Program menu. If you are in Setup mode, you exit setup and return to the Program menu.
2. **Pressing and holding the MENU button for five seconds leaves the current screen and displays the Setup menu.**

Left and Right Arrow Buttons (◀ and ▶)

Use these buttons to move backward (◀) and forward (▶) through the Program and Setup menus.

Up and Down Arrow Buttons (▲ and ▼)

1. Use these buttons to move your selection up and down through a menu or list. When the desired item is highlighted, you press the ▶ arrow button to display that item’s content.
2. When a value is displayed (e.g. 70°F), the up and down arrows increase and decrease the value.

Home Screen

In the normal run state, the LCD home screen displays the current sensed temperatures, the active status of the output relays (stages), and error and status codes.

Active relays are indicated by the small black square (■) just below the relay number. Fig. 15 on page 10 shows the home screen with relays 1, 2, and 4 energized.

When using Reset, the Heat/Cool setpoint displays on the home screen for the first four (4) staged outputs.

Pressing the ◀ and ▶ buttons from the home screen cycles through the sensor and stage displays (Fig. 15).

NOTE: Only the first four (4) stages can be displayed.

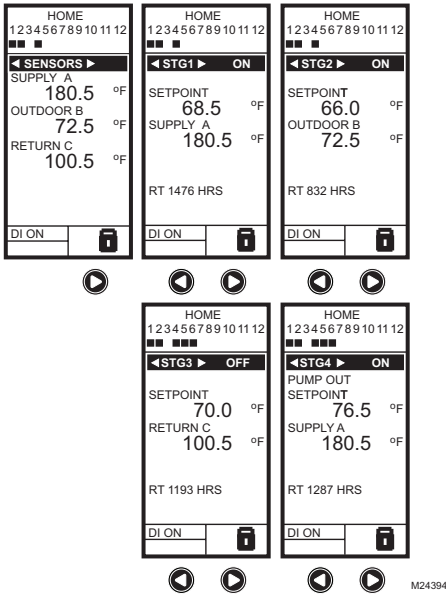

Fig. 15. LCD Display - Home Screen Displaying Sensors, Stages, and Pump Out.

NOTES:

1. The stage home screens do not dynamically update the active relay status and sensor values. The information is a snapshot taken when you press the ◀ or ▶ button to display the screen.
2. In Reset mode, the home screen displays the effective setpoint.

IMPORTANT

After four minutes of inactivity (no buttons pressed), the LCD display reverts to the home screen display.

Accessing the Menus

Menus are used for programming, scheduling, viewing the summary settings, and setup of advanced options.

Program, Schedule, and Summary Menus

To access these menus from the home screen, press the MENU button. See Fig. 16.

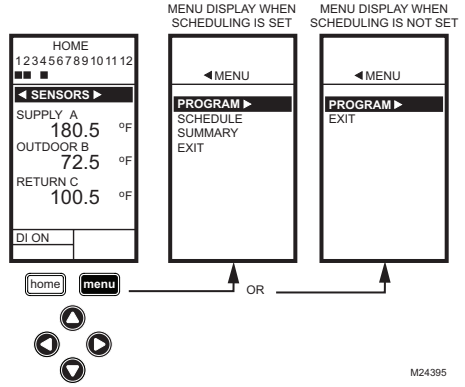

Fig. 16. Menus.

Depending on whether scheduling is enabled or not, the LCD displays one of two menus as shown in Fig. 16. Scheduling is enabled from the Setup menu's Output settings. See "1.3.2. SCHEDULE" on page 16.

Setup Menu

To access the Setup menu for advanced options, press and hold the MENU button for five seconds. See Fig. 17.

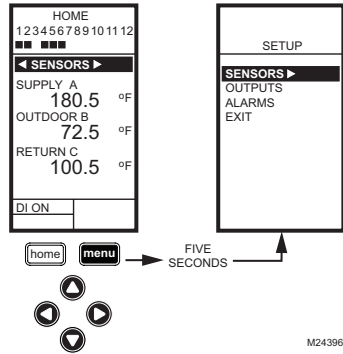

Fig. 17. Setup Menu.

Using the Menus

When you are working with the menus, use the:

- **Left arrow button (◀)** to scroll backward through the menu
- **Right arrow button (▶)** to select the highlighted menu item and display its content
- **Up and Down arrow buttons (▲ and ▼)** to scroll up and down through a list of items or to increase or decrease the value of a displayed parameter

NOTE: If you press the HOME button or there is no keypad activity for four minutes, you exit Setup mode and return to the home screen.

If you press the MENU button, you exit Setup mode and go to the Program menu.

PROGRAMMING OVERVIEW

The controller must be programmed before being placed into service.

IMPORTANT

During programming, the controller is live at all times. For example, the contacts may open and close when adjusting the setpoint.

The programming process uses a hierarchical menu structure that is easy to use. You press the ◀ and ▶ arrow buttons to move forward and backward through the menus.

NOTES:

1. The T775P controller interface is intuitive. You may want to use these procedures simply as a reference to locate the particular option or parameter of interest.
2. The menus can display only those relays that are defined in Setup (see "1.3.1. Number of STAGES" on page 15). For example, if you configure only one relay, then only one relay displays on the appropriate menus.
3. If you press the HOME button or there is no keypad activity for four minutes, you exit Program mode and return to the home screen.
4. If you press the MENU button, you exit Program mode and return to the menu.

Setpoint

The following describes the function of the setpoint for heating and cooling. One setpoint is programmed and is used by all the outputs (stages).

Heating Mode Setpoint

In heating mode, the relay de-energizes when the temperature rises to the setpoint. When the temperature drops to the setpoint, the relay energizes.

Cooling Mode Setpoint

In cooling mode, the relay de-energizes when the temperature falls to the setpoint. When the temperature rises to the setpoint, the relay energizes.

Setpoint High Limit

You can set an irreversible setpoint high limit maximum value for the displayed setpoint value.

Adjust the setpoint to the desired maximum setpoint. Then, simultaneously press the HOME, ◀, and ▶ buttons and continue to press all three buttons for five seconds to set the setpoint high limit maximum to this value.

NOTE: You must press all three buttons at exactly the same time for this action to occur.

IMPORTANT

1. This action sets the maximum setpoint value for all outputs to the setpoint high limit maximum.
2. Setting the high limit setpoint maximum is irreversible. If you perform the action inadvertently and this setpoint adversely affects the control of your system, you must replace the controller.

Stages (Relays) and Pump Output

The T775P model can be used to stage multiple relays from a single heat or cool setpoint. The number of stages can be freely chosen, limited by the number of relays available (up to 12 relays [11 if using the pump output] using two T775S expansion modules).

The T775P provides a pump output using the last of the four SPDT relay outputs on the T775P controller. When T775S Expansion Modules are used, the configurable pump output is the last relay output of the last expansion module. See Table 4.

Table 4. T775 Stages and Pump Output.

	Maximum Stages with No Pump Output	Maximum Stages with Pump Output	Relay # Used for Pump Output
T775P	4	3	4
T775P & one T775S	8	7	8
T775P & two T775S	12	11	12

IMPORTANT

If the stage configuration is changed (e.g., the number of stages [relays] changes) then you must re-select the pump stage. See "1. Setup" on page 12.

Staged Operation

Staging occurs as illustrated in Fig. 18 for a Heat setpoint of 200°F and a throttling range of 20°F when the Integral value is zero (0). When the Integral is not zero, then the actual temperatures at which stages energize and de-energize will vary from this example; see "1.3.3.2. INTEGRAL" on page 17.

NOTE: A non-zero integral causes the control to move toward the setpoint value.

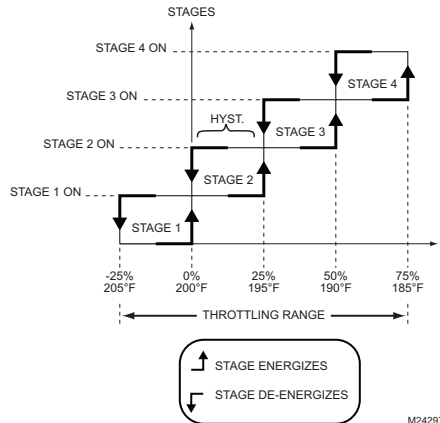

Fig. 18. Staging Behavior.

Sensor Control

Sensor A (supply) or Sensor C (return) must always be the controlled temperature. In Reset applications, Sensor B must always be the controlling temperature (e.g. the outside temperature), and is used only to reset the controlled setpoint. In Non-reset applications, Sensor B can be used to monitor some third temperature.

Programming the T775P Controller

To program the controller, perform the setup configuration (see "1. Setup") and then select one of the following procedures depending on whether the Reset function is to be used:

- Program the Outputs for Reset — see "2. Programming Output Stage(s) with Reset".

- Program the Outputs for No Reset — see "3. Programming Output Stage(s) with No Reset" on page 29.

When programming is complete, you may continue with "4. Scheduling" on page 31.

1. SETUP

Setup provides the ability to change the factory default settings for the temperature sensors and outputs, to enable/disable reset control, and to enable/disable scheduling.

IMPORTANT

If the stage configuration is changed (e.g., the number of stages [relays] changes) then you must re-select the pump stage in Setup.

NOTE: The T775P controller interface is intuitive. You may want to use this procedure simply as a reference to locate the particular option or parameter of interest.

NOTES:

1. If you press the **HOME** button or there is no keypad activity for four minutes, you exit Setup mode and return to the home screen.
2. If you press the **MENU** button, you exit Setup mode and go to the Program menu.

Once in Setup mode, you use the —

- **Left arrow button**(◀) to scroll backward through the Setup menus
- **Right arrow button**(▶) to select the highlighted menu item and display its content
- **Up and Down arrow buttons**(▲ and ▼) to scroll up and down through a list of items or to increase or decrease the value of a displayed setup parameter

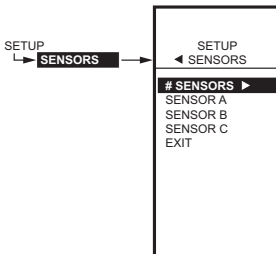

M24646

Fig. 19. Setup - Sensors Menu.

Setup Procedure

The Setup process uses a hierarchical menu structure that is easy to use. You press the ◀ and ▶ arrow buttons to move forward and backward through the menus.

NOTE: The menus can display only those relays that are defined in Setup (see "1.3.1. Number of STAGES" on page 15). For example, if you configure only two relays, then only two relays (stages) display on the appropriate menus.

To change the controller's sensors and output setup parameters, perform the following procedures in the order listed:

1. Enter Setup mode — see "1.1. Entering Setup Mode".
2. Setup Sensors — see "1.2. Setting up the Sensors".
3. Setup Outputs — see "1.3. Setting up the Outputs" on page 15.
4. Setup Alarms — see "1.4. Setup Alarms" on page 23.
5. Exit Setup Mode — see "1.5. Exiting Setup" on page 25.

1.1. Entering Setup Mode

To enter Setup mode, press and hold the MENU button for five seconds to display the Setup menu. See Fig. 17 on page 10.

1.2. Setting up the Sensors

1. From the Setup menu, use the ▲ and ▼ buttons to highlight SENSORS.
2. Press the ▶ button to display the Sensors menu.

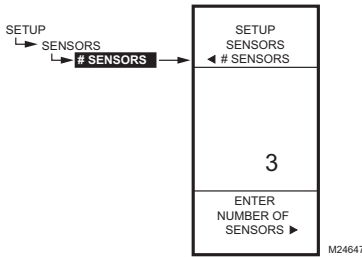

Fig. 20. Setup - Sensors - Number of Sensors.

1.2.1. Number of SENSORS

The value entered here determines the number of sensors displayed on the home screen.

NOTES:

- Three (3) sensors – if three sensors are selected, Sensor A (supply) or Sensor C (return) can be the controlled temperature. Sensor B must always be the controlling temperature (e.g. the outside temperature) in Reset applications. Sensors A, B, and C display on the home screen.
 - Two (2) sensors – If two sensors are selected, Sensors A & C display if NOT Resetting, and Sensors A (or C) & B display if Resetting. Sensor B is used only to reset the controlled setpoint.
 - One (1) sensor – If one sensor is selected, Sensor A or C displays on the home screen.
- From the Sensors menu, highlight # SENSORS then press the ▶ button to display the number of sensors.
 - Use the ▲ and ▼ buttons to enter the number of sensors (1, 2, or 3).
Default: 3
 - Press the ▶ button to accept the value and display the SENSOR A selection.

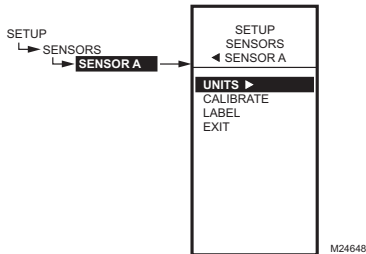

Fig. 21. Setup - Sensors - Sensor A Menu.

1.2.2. SENSOR A

If you are implementing two-sensor reset control, Sensor A (supply) or Sensor C (return) must always be the controlled temperature. Normally, Sensor A is used to sense the Supply temperature.

For example, in a reset control based on outside temperature, Sensor A or C must be the inside sensor and Sensor B must be the outside sensor.

- From the Sensors menu, highlight SENSOR A.
- Press the ▶ button to display the Sensor A selections.

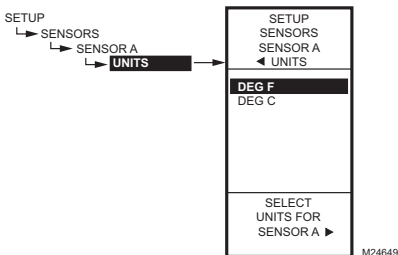

Fig. 22. Setup - Sensors - Sensor A - Units.

1.2.2.1. UNITS (°F or °C)

IMPORTANT

This is a global change and affects the unit values for all temperature parameters on all displays.

This UNITS screen displays only for Sensor A.

- From the Sensor A selections, use the ▲ and ▼ buttons to highlight UNITS.
- Press the ▶ button to display the temperature units.
- Use the ▲ and ▼ buttons to highlight DEG F or DEG C.
Default: F (Fahrenheit)
- Press the ▶ button to accept the units and return to the Sensor A selections.

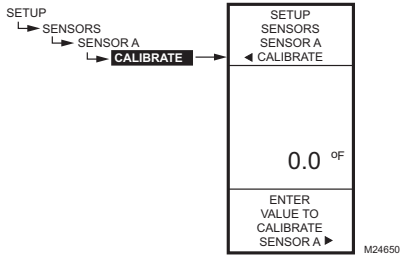

Fig. 23. Setup - Sensors - Sensor A - Calibrate.

1.2.2.2. CALIBRATE (the sensor)

Ensure that the wire size calibration value is within the limits. See "Temperature Sensor Calibration" on page 8.

1. From the Sensor selections, use the ▲ and ▼ buttons to highlight CALIBRATE.
2. Press the ► button to display the calibration degree value.
3. Use the ▲ and ▼ buttons to increase/decrease the desired calibration degrees.
Default: 0
Range: +/-10°F (+/-6°C)
4. Press the ► button to accept the value and return to the Sensor A selections.

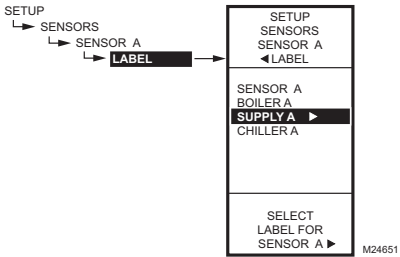

Fig. 24. Setup - Sensors - Sensor A - Label.

1.2.2.3. LABEL (the sensor input)

For a sensor already labeled, the display positions to and highlights that label.

1. From the Sensor selections, use the ▲ and ▼ buttons to highlight LABEL.
2. Press the ► button to display the label list.
3. Use the ▲ and ▼ buttons to scroll through list and highlight the desired label.
— For Sensor A, the label names are Sensor, Boiler, Supply, and Chiller. Supply is the default.
— For Sensor B, the label names are Sensor and Outdoor. Outdoor is the default.
— For Sensor C, the label names are Sensor, Boiler, Return, and Chiller. Return is the default.
4. Use the ► button to accept the highlighted label and exit the list.

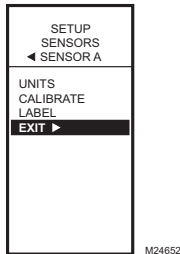

Fig. 25. Setup - Sensors - Exit.

1.2.2.4. Exit Sensor A Setup

Press the ◀ button to exit the Sensor A selections and return to the Sensors menu.

or
Use the ▲ and ▼ buttons to highlight EXIT and press the ► button.

Continue with "1.2.3. SENSOR B".

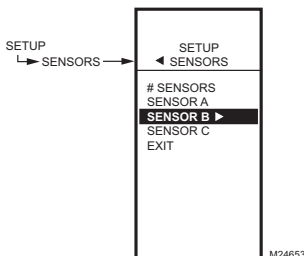

Fig. 26. Setup - Sensors - Sensor B Menu.

1.2.3. SENSOR B

For two-sensor reset control, Sensor B must always be the controlling temperature.

For example, in a reset control based on outside temperature, Sensor B must be the outside sensor.

1. From the Sensors menu, use the ▼ button to highlight SENSOR B.
2. Press the ► button to display the Sensor B menu.
3. Repeat the selections described in "1.2.2.2. CALIBRATE (the sensor)" through "1.2.2.4. Exit Sensor A Setup" beginning on page 14.

Continue with "1.2.4. SENSOR C".

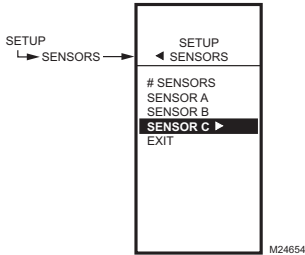

Fig. 27. Setup - Sensors - Sensor C Menu.

1.2.4. SENSOR C

Normally, Sensor C is used to sense the Return temperature and is used to activate the Differential alarm (the difference between Sensors A and C) and/or can be the controlled temperature sensor.

If you are implementing two-sensor reset control, Sensor A (supply) or Sensor C (return) must always be the controlled temperature.

1. From the Sensors menu, use the ▼ button to highlight SENSOR C.
2. Press the ► button to display the Sensor C menu.
3. Repeat the selections described in "1.2.2.2. CALIBRATE (the sensor)" through "1.2.2.4. Exit Sensor A Setup" beginning on page 14.

Continue with "1.3. Setting up the Outputs".

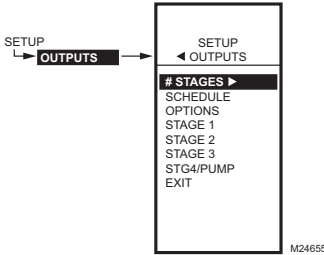

Fig. 28. Setup - Outputs Menu.

1.3. Setting up the Outputs

1. From the Setup menu, use the ▲ and ▼ buttons to highlight OUTPUTS.
2. Press the ► button to display the Outputs menu

Continue with "1.3.1. Number of STAGES".

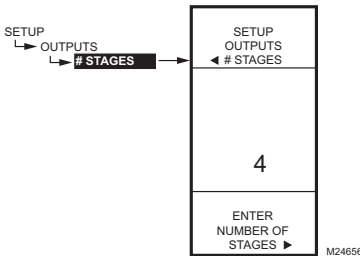

Fig. 29. Setup - Outputs - Number of Stages.

1.3.1. Number of STAGES

1. From the Outputs menu, use the ▲ and ▼ buttons to highlight # STAGES.
2. Press the ► button to display the number of stages.
3. Use the ▲ and ▼ buttons to select the number of stages depending on setup. (See note below.)
Default: 4
4. Press the ► button to accept the value and display the Outputs menu.

NOTE: Up to two T775S Expansion Modules can be connected to a T775P, making the following outputs (stages) available:
T775P: 4 relay outputs (4 stages).
T775P with one T775S module: 8 relay outputs (8 stages).
T775P with two T775S modules: 12 relay outputs (12 stages).

NOTE: The last output is available to be used as the pump output. For example, a T775P with one expansion module provides 8 outputs, and the last output (#8) is available for use as the pump output. See "1.3.5. Setup Last Output" on page 21.

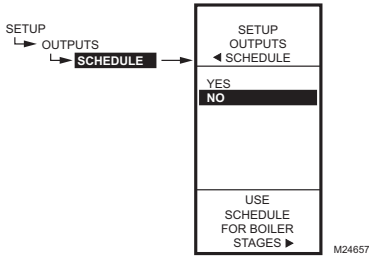

Fig. 30. Setup - Outputs - Schedule.

1.3.2. SCHEDULE

1. From the Outputs menu, use the ▲ and ▼ buttons to highlight SCHEDULE.
 2. Press the ► button to display the value.
 3. Use the ▲ and ▼ buttons to select YES or NO. Default: NO
 4. Press the ► button to accept the value and display the Outputs menu.
- Selecting NO disables scheduling for **all** outputs (stages).
 - Selecting YES enables scheduling for the setpoint.

With Scheduling enabled, when you return to Program mode, the new option for Scheduling displays. You can press the HOME button and then the MENU button to view the Schedule options in the menu.

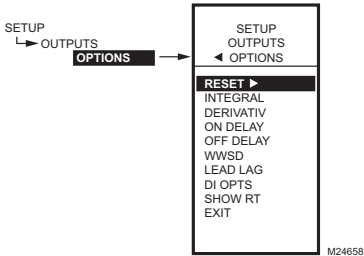

Fig. 31. Setup - Outputs - Options Menu.

1.3.3. OPTIONS

1. From the Outputs menu, use the ▲ and ▼ buttons to highlight OPTIONS.
2. Press the ► button to display the Options menu.

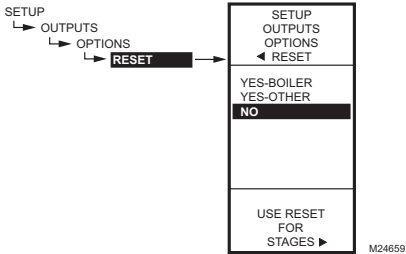

Fig. 32. Setup - Outputs - Options - Reset.

1.3.3.1. RESET

1. From the Options menu, use the ▲ and ▼ buttons to highlight RESET.
2. Press the ► button to display the value. Default: NO
3. Use the ▲ and ▼ buttons to select the value.
4. Press the ► button to accept the value and display the Options menu.

If you select NO, then No Reset is configured.

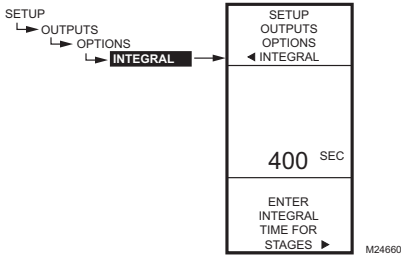

Fig. 33. Setup - Outputs - Options - Integral.

NOTES:

1. The Integral time is factory set for 400 seconds. This is a good middle range and should satisfy many applications. The integral time can be increased for applications where sensed response is slow, and can be decreased for applications where sensed response is fast (e.g. discharge air control).
2. As a starting point, an optimal integral time for discharge air typically ranges from 12 to 200 seconds. An optimal integral time for room control typically ranges from 60 to 2,500 seconds. The purpose of integral action is to reduce or eliminate the offset from setpoint during steady state control that is often seen in proportional only control.

1.3.3.2. INTEGRAL

1. From the Options menu, use the ▲ and ▼ buttons to highlight INTEGRAL.
2. Press the ► button to display the integral value.
3. Use the ▲ and ▼ buttons to increase/decrease the integral time from 0 to 3,600 seconds in increments of 10 seconds.
Default: 400 seconds
Range: 0 to 3,600 seconds
4. Press the ► button to accept the value and display the Options menu.

3. Keep in mind that control is most sensitive to throttling range. Adjust the throttling range first before any adjustment to integral time. Adjust throttling range to be as wide as possible to start since this will provide the most stable control. Remember that the integral will eliminate the steady state error so you do not need to have a small throttling range to have accurate control. (Integral action means that even though your throttling range is 20 degrees you can still control to +/- 1 degree with the proper integral time).

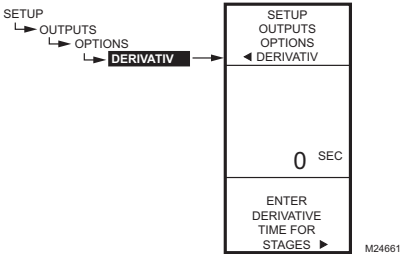

Fig. 34. Setup - Outputs - Options - Derivative.

1.3.3.3. DERIVATIVE

The Derivative default value is factory set to zero (no derivative control). It is strongly recommended that the derivative remain at zero (0) unless you have a very good reason to adjust it. Derivative control is not needed in the vast majority of HVAC applications.

1. From the Options menu, use the ▲ and ▼ buttons to highlight DERIVATIVE.
2. Press the ► button to display the derivative seconds.
3. Use the ▲ and ▼ buttons to increase/decrease the value.
Default: 0 (zero)
Range: 0 to 3,600 seconds
4. Press the ► button to accept the value and display the Options menu.

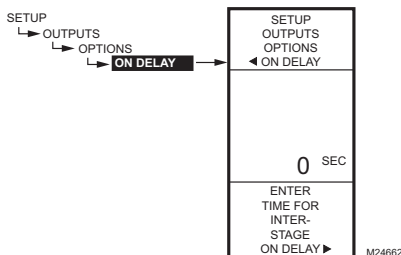

Fig. 35. Setup - Outputs - Options - On Delay.

1.3.3.4. ON DELAY

This is the minimum time delay between consecutive ON stages.

1. From the Options menu, use the ▲ and ▼ buttons to highlight ON DELAY, then press the ► button to display the interstage on delay.
2. Use the ▲ and ▼ buttons to increase/decrease the on delay time.
Default: 0 (zero) seconds
Range: 0 to 3,600 seconds in 10 second increments
There is a built-in minimum delay of 1 second between stages upon energizing.
3. Press the ► button to accept the value and display the Options menu.

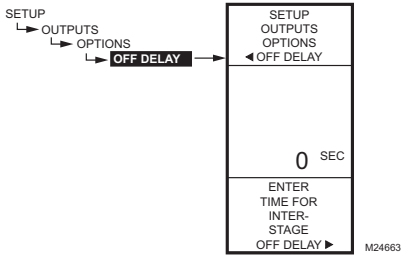

Fig. 36. Setup - Outputs - Options - Off Delay.

1.3.3.5. OFF DELAY

This is the minimum time delay between consecutive OFF stages.

1. From the Options menu, use the ▲ and ▼ buttons to highlight OFF DELAY, then press the ► button to display the interstage off delay.
2. Use the ▲ and ▼ buttons to increase/decrease the off delay time from 0 to 990 seconds in increments of 10 seconds.
 Default: 0 (zero) seconds
 Range: 0 to 3,600 seconds in 10 second increments
 There is a built-in minimum delay of 1 second between stages upon energizing.
3. Press the ► button to accept the value and display the Options menu.

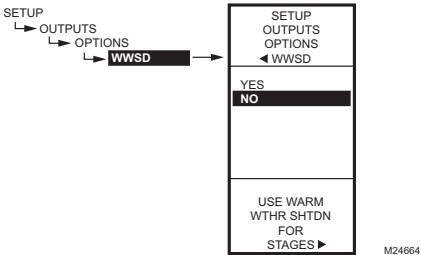

Fig. 37. Setup - Outputs - Options - WWSD.

1.3.3.6. WWSD

This option selects the warm weather shutdown for stages.

1. From the Options menu, use the ▲ and ▼ buttons to highlight WWSD, then press the ► button to display the value.
2. Use the ▲ and ▼ buttons to select the value.
 Default: NO
3. Press the ► button to accept the value and display the Options menu.

If YES is selected, the WWSD TEMP item appears in the Options menu.

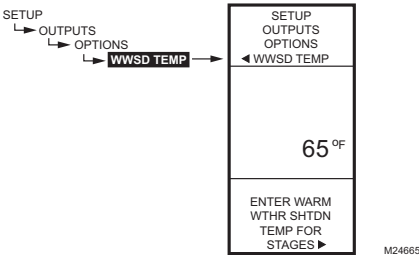

Fig. 38. Setup - Outputs - Options - WWSD.

1.3.3.7. WWSD TEMP

The option for the warm weather shutdown temperature for stages displays when the WWSD option is selected as YES.

1. From the Options menu, use the ▲ and ▼ buttons to highlight WWSD TEMP, then press the ► button to display the warm weather shutdown temperature.
2. Use the ▲ and ▼ buttons to increase/decrease the temperature.
 Default: 65°F (18°C)
 Range: 30 to 100°F (-1 to 38°C)
3. Press the ► button to accept the value and display the Options menu.

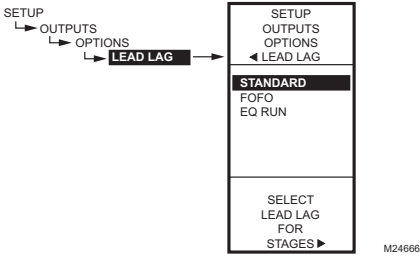

Fig. 39. Setup - Outputs - Options - Lead Lag.

1.3.3.8. LEAD LAG

- From the Options menu, use the ▲ and ▼ buttons to highlight LEAD LAG.
 - Press the ► button to display the values STANDARD, FOFO (First On / First Off), and EQ RUN (equal runtime).
 - Use the ▲ and ▼ buttons to select the value.
Default: STANDARD
 - Press the ► button to accept the value and display the Options menu.
- Standard** – The controller energizes the stages in order. For example, if there are four stages, they energize as 1, 2, 3, and finally 4. Stages de-energize in the opposite order, 4, 3, 2, and finally 1.
 - FOFO** (First On, First Off) – Serves to help equalize runtime between stages. The first stage to energize in a series is the first stage to de-energize. So if stages 1, 2, 3, and 4 energize in that order, then these stages de-energize in that same order, 1, 2, 3, and finally 4.
 - EQ RUN** (Equal Runtime) – The controller energizes the stages in the order of lowest run-time. If there are four stages and the runtime on each stage is as follows: stage 1=6 hours, stage 2=3 hours, stage 3=4 hours, stage 4=10 hours, then the stages energize 2, 3, 1, and finally 4. Stages de-energize in the order of highest runtime.

NOTE: FOFO and EQ RUN can be used for up to 12 stages. The run times are tracked for all stages, however only the run times for stages 1 through 4 display on the home screen.

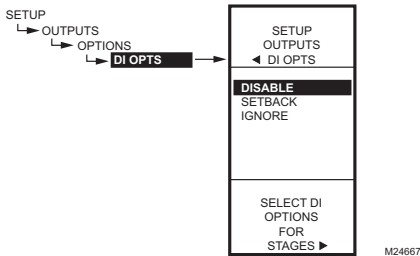

Fig. 40. Setup - Outputs - Options - DI Options.

1.3.3.9. DI OPTIONS (digital input options)

The DI Option that you select applies to **all** outputs. This option overrides any Setpoint/Setback values entered in the Schedule.

- Press the ► button to display the DI Option selections.
- Use the ▲ and ▼ buttons to highlight DISABLE, SETBACK, or IGNORE.
Default: DISABLE
- Press the ► button to accept the value and display the SHOW RT menu.

When the digital input (DI) closes, all outputs (stages) follow the DI option value (Disable, Setback, or Ignore):

- DISABLE** disables the outputs; relays return to their de-energized state.
- SETBACK** enables a single setback temperature value to be programmed for all outputs.
 - To program the Setback temperature with Reset, see Fig. 72 on page 29.
 - To program the Setback temperature without Reset, see Fig. 78 on page 31.
- IGNORE** causes the digital input to have no effect on the relay outputs.

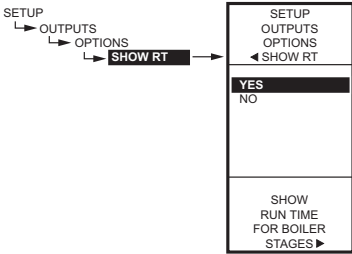

M24668

Fig. 41. Setup - Outputs - Options - Show Runtime.

1.3.3.10. SHOW RT (show run time hours)

1. Press the ▶ button to display the Show RT values.
2. Use the ▲ and ▼ buttons to select YES or NO. Default: YES
3. Press the ▶ button to accept the value and return to the Options menu.

Selecting YES shows the RT (run time) hours for the first four stages on the home screen displays. Stages 5-12 are not displayed.

NOTE: Run times can be reset to zero for the first four (4) stages. You must do this for each of the stages (1-4) that you want to reset to zero. See "1.3.4.1.1. RESET RT (run time)" on page 21.

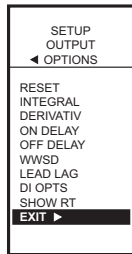

M24669

Fig. 42. Setup - Outputs - Options - Exit.

1.3.3.11. Exit Options Setup

Press the ◀ button (or highlight EXIT and press the ▶ button) to exit and return to the Outputs menu.

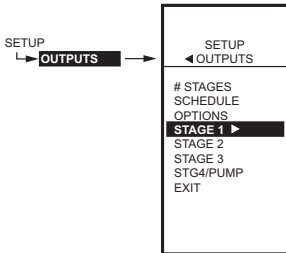

M24670

Fig. 43. Setup - Outputs - Stage Menu.

1.3.4. Setting up the Stages

1. From the Outputs menu, use the ▲ and ▼ buttons to highlight the desired Stage.
2. Press the ▶ button to display the selected Stage menu.

NOTES:

1. Only the first four (4) stages have run time reset options.
2. The relay outputs are used as stages with the last relay available to be configured as the pump output. See Table 4 on page 11.

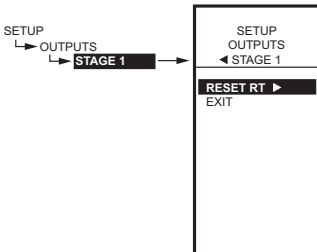

M24671

Fig. 44. Setup - Outputs - Stage.

1.3.4.1. STAGE

The first four (4) stages have one setup option, Reset Runtime. This option displays only if Show RT is configured in Setup (see Fig. 41).

1. From the Stage menu, use the ▲ and ▼ buttons to highlight the RESET RT option.
2. Press the ▶ button to display the option.

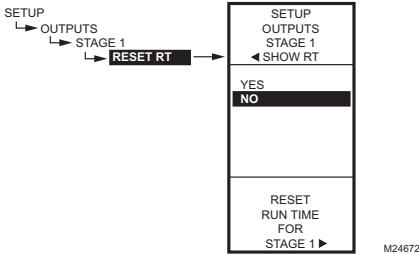

Fig. 45. Setup - Outputs - Stage - Reset Runtime.

1.3.4.1.1. RESET RT (run time)

This selection displays only if "Show RT = YES" is selected during Output Options setup (see Fig. 41).

1. Press the ▶ button to display the Reset RT values.
2. Use the ▲ and ▼ buttons to select YES or NO. Default: NO
3. Press the ▶ button to accept the value and return to the Stage menu.

Selecting YES immediately resets the relay output run time hours to zero for this stage. When you subsequently return to this screen, the RESET RT defaults to NO.

NOTE: Run times can be reset to zero for the first four (4) stages. You must do this for each of the stages (1-4) that you want to reset to zero.

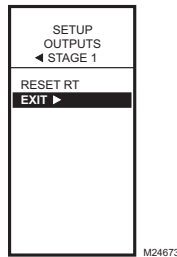

Fig. 46. Setup - Outputs - Stage - Exit.

1.3.4.1.2. Exit Stage Setup

Press the ◀ button (or highlight EXIT and press the ▶ button) to exit the current Stage setup and return to the Outputs menu.

To setup the next stage go to "1.3.4. Setting up the Stages" on page 20.

To setup the last stage, continue with "1.3.5. Setup Last Output".

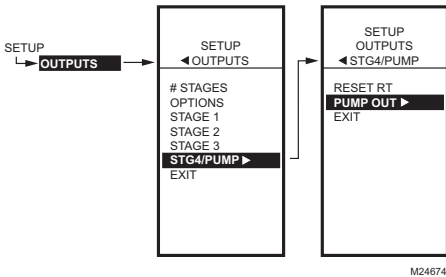

Fig. 47. Setup Last Output.

1.3.5. Setup Last Output

The last relay output is available to be configured as the pump output.

1. From the Outputs menu, use the ▲ and ▼ buttons to highlight the last Stage (Fig. 47 shows Stage 4 as the last relay output).
2. Press the ▶ button to display the Stage/Pump menu.

NOTE: Reset RT displays only if "Show RT = YES" is selected during Output Options setup (see Fig. 41).

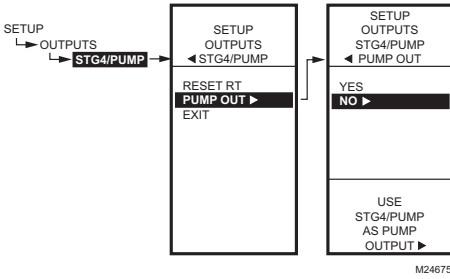

Fig. 48. Setup Pump Output.

1.3.6. Enable/Disable Pump Output

1. From the Stage/Pump menu, use the ▲ and ▼ buttons to highlight the PUMP OUT option.
2. Press the ► button to display the Pump Out menu.
3. Use the ▲ and ▼ buttons to select YES or NO.
Default: NO
4. Press the ► button to accept the value and return to the Stage/Pump menu.

If you do not have a pump output, select NO and press the ► button to exit this screen. Go to “1.3.7.4. Pump Exit” on page 23.

Selecting YES displays the pump options on the Pump menu once you exit this screen.

Continue with “1.3.7. Pump Output Options”.

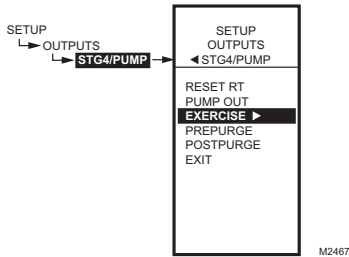

Fig. 49. Setup Pump Output Options.

1.3.7. Pump Output Options

The Pump Output options display on the Stage/Pump menu once you enable the pump output.

Reset RT displays only if “Show RT = YES” is selected during Output Options setup (see Fig. 41).

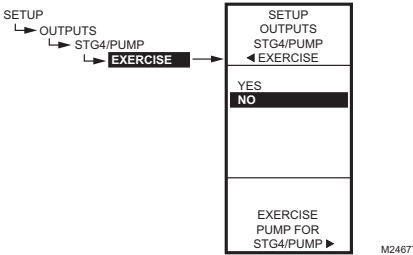

Fig. 50. Setup Pump Exercise.

1.3.7.1. EXERCISE

1. From the Stage/Pump menu, use the ▲ and ▼ buttons to select EXERCISE.
2. Press the ► button to display the Exercise option.
3. Use the ▲ and ▼ buttons to select YES or NO.
Default: NO
4. Press the ► button to accept the value and display the Stage/Pump menu.

If Exercise is selected and there is no pump activity, the controller energizes the pump output for 15 seconds every 48 hours.

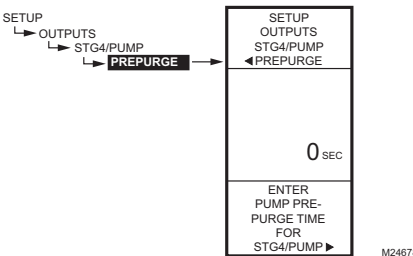
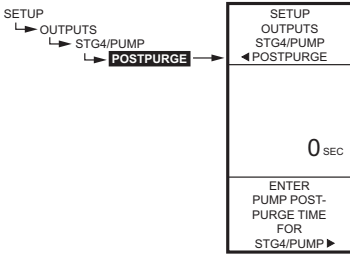

Fig. 51. Setup Pump Prepurge.

1.3.7.2. PREPURGE

1. From the Stage/Pump menu, use the ▲ and ▼ buttons to select PREPURGE.
2. Press the ► button to display the prepurge time.
3. Use the ▲ and ▼ buttons to increase/decrease the prepurge time.
Default: 0 (zero) seconds
Range: -300 to 300 seconds
4. Press the ► button to accept the value and display the Stage/Pump menu.



M24679

Fig. 52. Setup Pump Postpurge.

1.3.7.3. POSTPURGE

1. From the Stage/Pump menu, use the ▲ and ▼ buttons to select POSTPURGE.
2. Press the ► button to display the postpurge time.
3. Use the ▲ and ▼ buttons to increase/decrease the postpurge time.
Default: 0 (zero) seconds
Range: 0 to 300 seconds
4. Press the ► button to accept the value and display the Stage/Pump menu.

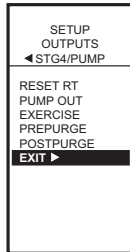

M24680

Fig. 53. Setup Pump Exit.

1.3.7.4. Pump Exit

Press the ◀ button (or highlight EXIT and press the ► button) to exit the current Stage/Pump menu and return to the Outputs menu.

This completes the pump setup. Continue with "1.4. Setup Alarms".

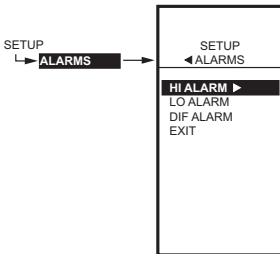

M24681

Fig. 54. Setup Alarms.

1.4. Setup Alarms

1. From the Setup menu, use the ▲ and ▼ buttons to highlight the Alarms.
2. Press the ► button to display the Alarms menu.

There are three alarms available, High, Low, and Differential. When an alarm is selected, its alarm limit selection displays on the Alarms menu.

When an alarm is active, the Digital Output (D.O.) closes and "ALARM" displays on the home screen.

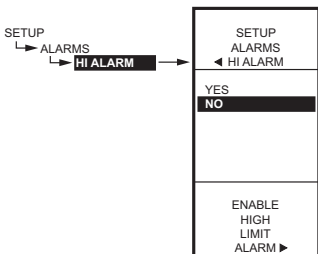

M24682

Fig. 55. Setup High Alarm.

1.4.1. HIGH ALARM

Only Sensor A can be used to sense the high alarm temperature. Sensor C cannot be used.

1. From the Alarms menu, use the ▲ and ▼ buttons to select HI ALARM.
2. Press the ► button to display the alarm options.
3. Use the ▲ and ▼ buttons to select YES or NO.
Default: NO
4. Press the ► button to accept the value and display the Alarms menu.

Selecting YES displays the HI LIMIT option on the Alarms menu once you exit this screen. Continue with "1.4.1.1. HIGH LIMIT" on page 24.

For systems with no high limit alarm, select NO, press the ► button, and continue with "1.4.2. LOW ALARM" on page 24.

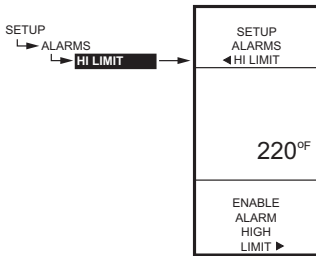

M24683

Fig. 56. Setup High Alarm Limit.

1.4.1.1. HIGH LIMIT

1. From the Alarms menu, use the ▲ and ▼ buttons to highlight HI LIMIT.
2. Press the ► button to display the high alarm limit temperature.
3. Use the ▲ and ▼ buttons to increase/decrease the temperature.
Default: 220°F (104°C)
Range: -10 to 248°F (-23 to 120°C)
4. Press the ► button to accept the value and display the Alarms menu.

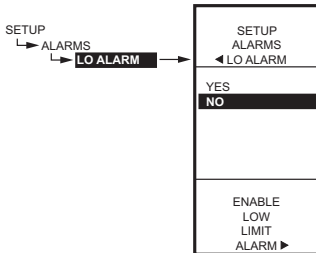

M24684

Fig. 57. Setup Low Alarm.

1.4.2. LOW ALARM

Only Sensor A can be used to sense the low alarm temperature. Sensor C cannot be used.

1. From the Alarms menu, use the ▲ and ▼ buttons to select LO ALARM.
2. Press the ► button to display the alarm options.
3. Use the ▲ and ▼ buttons to select YES or NO.
Default: NO
4. Press the ► button to accept the value and display the Alarms menu.

Selecting YES displays the LO LIMIT option on the Alarms menu once you exit this screen. Continue with "1.4.2.1. LO LIMIT".

For systems with no low limit alarm, select NO, press the ► button, and continue with "1.4.3. DIF ALARM" on page 25.

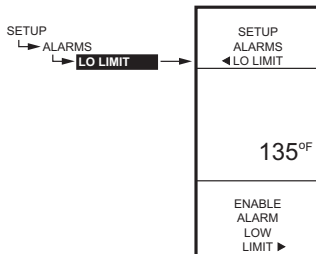

M24685

Fig. 58. Setup Low Alarm Limit.

1.4.2.1. LO LIMIT

1. From the Alarms menu, use the ▲ and ▼ buttons to highlight LO LIMIT.
2. Press the ► button to display the low alarm limit temperature.
3. Use the ▲ and ▼ buttons to increase/decrease the temperature.
Default: 135°F (57°C)
Range: -30 to 220°F (-34 to 104°C)
4. Press the ► button to accept the value and display the Alarms menu.

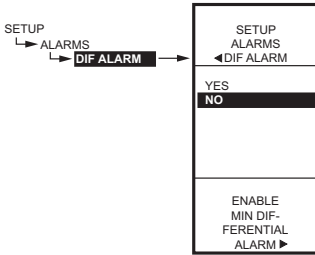

Fig. 59. Setup Differential Alarm.

M24686

1.4.3. DIF ALARM

The Differential Alarm activates when the difference between Sensors A and C drops below the DIF LIMIT.

1. From the Alarms menu, use the ▲ and ▼ buttons to select DIF ALARM.
2. Press the ► button to display the alarm options.
3. Use the ▲ and ▼ buttons to select YES or NO.
Default: NO
4. Press the ► button to accept the value and display the Alarms menu.

Selecting YES displays the DIF LIMIT option on the Alarms menu once you exit this screen. Continue with "1.4.3.1. DIF LIMIT".

For systems with no differential limit alarm, select NO, press the ► button, and continue with "1.5. Exiting Setup".

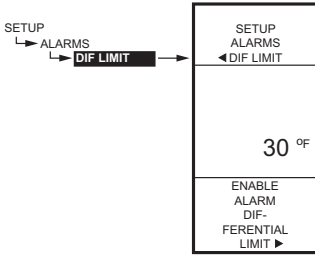

Fig. 60. Setup Differential Alarm Limit.

M24687

1.4.3.1. DIF LIMIT

The differential alarm limit is the minimum temperature difference between Sensors A and C that causes the alarm to activate.

1. From the Alarms menu, use the ▲ and ▼ buttons to highlight DIF LIMIT.
2. Press the ► button to display the differential alarm limit minimum temperature.
3. Use the ▲ and ▼ buttons to increase/decrease the temperature.
Default: 30°F (°C)
Range: 0 to 200°F (- to °C)
4. Press the ► button to accept the value and display the Alarms menu.
5. Press the ◀ button to exit the Alarms menu and return to the Setup menu.

This completes the Alarm setup. Continue with "1.5. Exiting Setup".

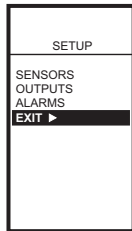

Fig. 61. Setup Exit.

M24688

1.5. Exiting Setup

Press the HOME button to exit Setup mode and return to the home screen display.

or
Use the ▲ and ▼ buttons to highlight EXIT from the Setup menu and press the ► button.

This completes the Setup procedure.

2. PROGRAMMING OUTPUT STAGE(S) WITH RESET

The T775P can be programmed for Reset or No Reset. From the factory, the T775P is programmed for No Reset. This section describes the steps necessary to program the controller for Reset.

To use the Reset feature, the Reset Option must be set to Reset=YES in Setup mode (see "2.1. Setting Up the Controller for Reset").

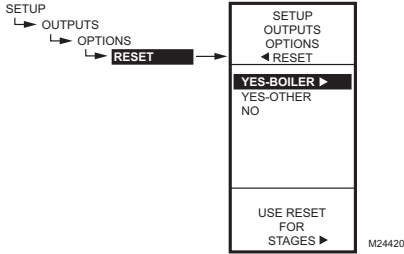

Fig. 62. Reset Setup.

2.1. Setting Up the Controller for Reset

1. Press and hold MENU for five seconds to enter Setup mode.
2. Then choose:
 - OUTPUTS ►
 - OPTIONS ►
 - RESET ►
 then select YES-BOILER or YES-OTHER as shown in Fig. 62.

You can now press the HOME button to exit Setup mode and continue with "Determining and Setting the Reset Values".

Determining and Setting the Reset Values

NOTE: When using the Reset feature, Sensor A must be sensing the controlled temperature (e.g. boiler), Sensor B must be sensing the resetting temperature (e.g. outdoor temp).

To program an output with Reset, refer to the values as shown in the examples below and in Fig. 63. Choose your own appropriate values for Sensor A maximum and minimum and Sensor B maximum and minimum.

Reset Example:

- Sensor A is the boiler sensor and Sensor B is the outdoor sensor.
- Maximum boiler temperature desired is 210°F when the outdoor temperature is 20°F.
- Minimum boiler temperature desired is 160°F when the outdoor temperature is 70°F.
- With the above settings example, when the outdoor temperature is 50°F, the effective setpoint is 180°F.

Setback Example (Optional):

- Setback of -10°F is used to drop the temperature at night by 10°F.
- With the above settings example, when the outdoor temperature is 50°F, the effective setback setpoint is 170°F (180°F setpoint minus the 10°F setback).

When Reset is programmed, the home screen conveniently displays the calculated Heat/Cool setpoint for the Stages based on the reset curve. See Fig. 15 on page 10.

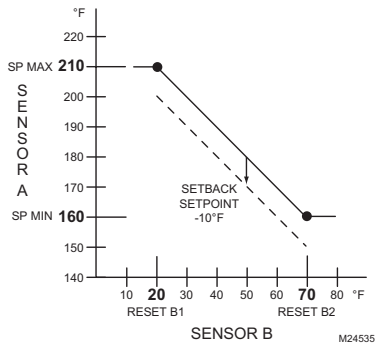

Fig. 63. Reset Curve with Setback Setpoint.

The remainder of this section beginning with "2.2. Program Menu for Reset" on page 27 describes the individual parameters for configuring the controller with Reset.

For your reference, the following Reset programming procedure uses the values in Fig. 63.

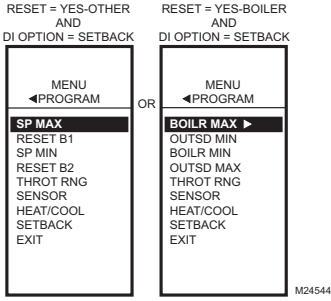

Fig. 64. Setpoint Values for Reset and Setback.

2.2. Program Menus for Reset

Press the MENU button, then select PROGRAM and press the ► button to view the Program menu.

Fig. 64 shows the menus for Reset-Other and Reset-Boiler. Your menu is the one chosen in "2.1. Setting Up the Controller for Reset" on page 26.

NOTE: The Setback parameter displays only if scheduling is enabled (see Fig. 30 on page 16) or the DI Option is set to Setback. (see Fig. 40 on page 19).

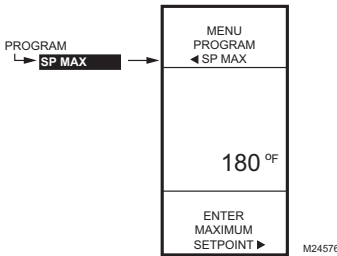

Fig. 65. Program - Sensor A - Max. Setpoint.

2.2.1. SP MAX or BOILER MAX

Setpoint maximum for Sensor A.

1. From the menu, use the ▲ and ▼ buttons to highlight SP MAX or BOILER MAX.
2. Press the ► button to display the maximum setpoint value.
3. Use the ▲ and ▼ buttons to increase/decrease the desired maximum setpoint temperature.
Default: 180°F (82°C)
Range: -40°F to 248°F (-40°C to 120°C)
4. Press the ► button to accept the setpoint temperature and display the next option.

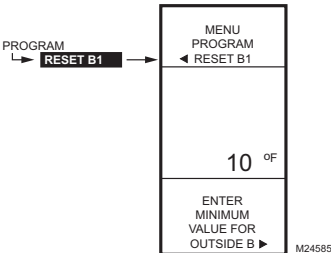

Fig. 66. Program - Sensor B - Min. Setpoint.

2.2.2. RESET B1 or OUTSD MIN

Sensor B value when Sensor A setpoint is at maximum.

1. From the menu, use the ▲ and ▼ buttons to highlight RESET B1 or OUTSD MIN.
2. Press the ► button to display the setpoint value.
3. Use the ▲ and ▼ buttons to increase/decrease the desired setpoint temperature.
Default: 10°F (-12°C)
Range: -40°F to 248°F (-40°C to 120°C)
4. Press the ► button to accept the value and display the next option.

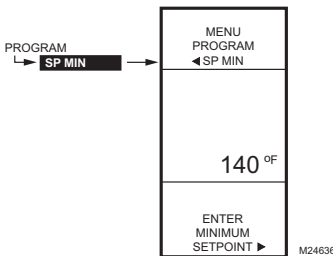

Fig. 67. Program - Sensor A - Min. Setpoint.

2.2.3. SP MIN or BOILER MIN

Setpoint minimum for Sensor A.

1. From the menu, use the ▲ and ▼ buttons to highlight SP MIN or BOILER MIN.
2. Press the ► button to display the setpoint value.
3. Use the ▲ and ▼ buttons to increase/decrease the desired minimum setpoint temperature.
Default: 140°F (60°C)
Range: -40°F to 248°F (-40°C to 120°C)
4. Press the ► button to accept the setpoint temperature and display the next option.

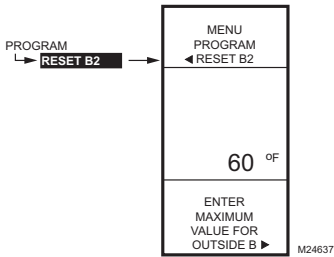

Fig. 68. Program - Sensor B - Max. Setpoint.

2.2.4. RESET B2 or OUTSD MAX

Sensor B value when Sensor A is at minimum.

1. From the menu, use the ▲ and ▼ buttons to highlight RESET B2 or OUTSD MAX.
2. Press the ► button to display the setpoint value.
3. Use the ▲ and ▼ buttons to increase/decrease the desired setpoint temperature.
Default: 60°F (16°C)
Range: -40°F to 248°F (-40°C to 120°C)
4. Press the ► button to accept the value and display the next option.

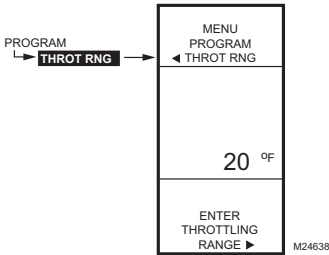

Fig. 69. Program - Throttling Range.

2.2.5. THROTTLING RANGE

The throttling range brackets the setpoint setting, e.g., if the setpoint is 72°F and the throttling range is 10°F, then the effective throttling temperature range is 67°F to 77°F.

1. From the menu, use the ▲ and ▼ buttons to highlight THROT RNG.
2. Press the ► button to display the throttling range value.
3. Use the ▲ and ▼ buttons to increase/decrease the desired value.
Default: 20°F (-6.6°C)
Range: 1°F to 150°F (1°C to 66°C)
4. Press the ► button to accept the value and display the next option.

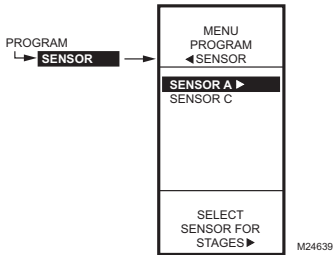

Fig. 70. Program - Sensor Selection.

2.2.6. SENSOR

Select Sensor A to use the Supply sensor as the controlled temperature.

Select Sensor C to use the Return sensor as the controlled temperature.

1. From the menu, use the ▲ and ▼ buttons to highlight SENSOR.
2. Press the ► button to display the sensor selections.
3. Use the ▲ and ▼ buttons to select Sensor A or C.
Default: Sensor A
4. Press the ► button to accept the highlighted sensor and display the next option.

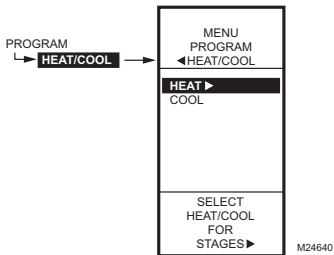

Fig. 71. Program - Heat/Cool Selection.

2.2.7. HEAT/COOL

1. From the menu, use the ▲ and ▼ buttons to highlight HEAT/COOL.
Default: HEAT
2. Press the ► button to display the heat and cool selections.
3. Use the ▲ and ▼ buttons to select Heat or Cool.
4. Press the ► button to accept the value and display the next option.

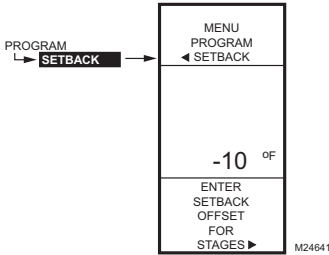

Fig. 72. Program - Setback Offset.

2.2.8. SETBACK OFFSET (if configured)

The Setback temperature option displays only if scheduling is enabled (see Fig. 30 on page 16) or the DI Option is set to Setback. (see Fig. 40 on page 19).

This value is the number of degrees plus (+) or minus (-) that you want the temperature to be offset from the setpoint.

For example, If you want the temperature to be 10°F less than the setpoint during setback mode, enter -10°F. In normal operations for heating, the offset will be negative. For cooling, the offset will be a positive value.

1. From the menu, use the ▲ and ▼ buttons to highlight SETBACK.
2. Use the ▲ and ▼ buttons to increase/decrease the desired setpoint temperature.
Default: 0°F
Range: -150°F to 150°F (-101°C to 66°C)
3. Press the ► button to accept the value and display the Program menu.

2.3. Exit Programming with Reset

Press the HOME button to leave programming mode and return to the home screen.

This completes the programming procedure for a T775P controller that uses Reset.

3. PROGRAMMING OUTPUT STAGE(S) WITH NO RESET

The T775P can be programmed for Reset or No Reset. From the factory, the T775P is programmed for No Reset. This section describes the steps necessary to program the controller for No Reset.

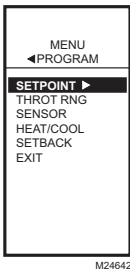

Fig. 73. Program Menu - No Reset.

3.1. Entering Program Mode

Press the MENU button, then select PROGRAM and press the ► button to view the Program menu.

NOTE: The Setback parameter displays only if scheduling is enabled (see Fig. 30 on page 16) or the DI Option is set to Setback (see Fig. 40 on page 19).

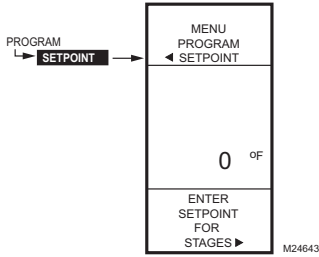

Fig. 74. Program - Setpoint.

3.1.1. SETPOINT

1. From the menu, use the ▲ and ▼ buttons to highlight SETPOINT.
2. Press the ► button to display the setpoint value.
3. Use the ▲ and ▼ buttons to increase/decrease the desired setpoint temperature.
Default: 0°F (-18°C)
Range: -40°F to 248°F (-40°C to 120°C)
4. Press the ► button to accept the setpoint temperature and display the next option.

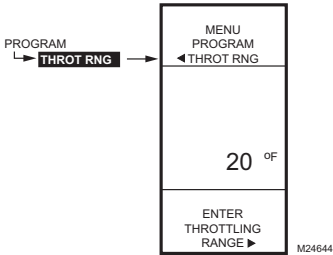

Fig. 75. Program - Throttling Range.

3.1.2. THROTTLING RANGE

The Throttling Range brackets the setpoint setting, e.g., if the setpoint is 72°F and the throttling range is 10°F, then the effective throttling temperature range is 67°F to 77°F.

1. From the menu, use the ▲ and ▼ buttons to highlight THROT RNG.
2. Press the ► button to display the throttling range value.
3. Use the ▲ and ▼ buttons to increase/decrease the desired value.
Default: 20°F (-6.6°C)
Range: 1°F to 150°F (1°C to 66°C)
4. Press the ► button to accept the value and display the next option.

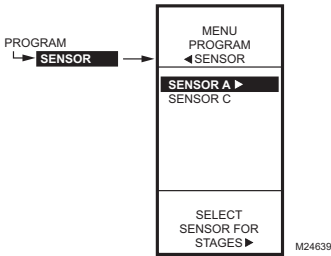

Fig. 76. Program - Sensor Selection.

3.1.3. SENSOR

Select Sensor A to use the Supply sensor as the controlled temperature.
Select Sensor C to use the Return sensor as the controlled temperature.

1. From the menu, use the ▲ and ▼ buttons to highlight SENSOR.
2. Press the ► button to display the sensor selections.
3. Use the ▲ and ▼ buttons to select Sensor A or C.
Default: Sensor A
4. Press the ► button to accept the highlighted sensor and display the next option.

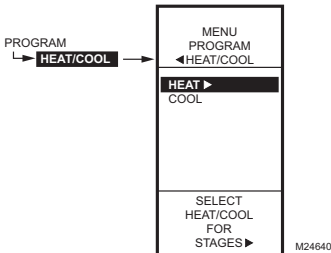

Fig. 77. Program - Heat/Cool Selection.

3.1.4. HEAT/COOL

1. From the menu, use the ▲ and ▼ buttons to highlight HEAT/COOL.
Default: HEAT
2. Press the ► button to display the heat and cool selections.
3. Use the ▲ and ▼ buttons to select Heat or Cool.
4. Press the ► button to accept the value and display the next option.

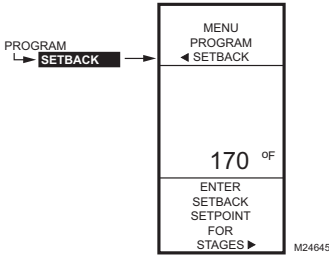

Fig. 78. Program - Setback Setpoint.

3.1.5. SETBACK SETPOINT (if configured)

The Setback temperature option displays only if scheduling is enabled (see Fig. 30 on page 16) or the DI Option is set to Setback (see Fig. 40 on page 19).

This is the desired setpoint temperature that you want to use during setback mode. For example, if your setpoint is 180°F and you want the temperature to drop 10°F during setback mode, enter 170°F as the setpoint.

1. From the menu, use the ▲ and ▼ buttons to highlight SETBACK.
2. Use the ▲ and ▼ buttons to increase/decrease the desired setpoint temperature.
Default: 0
Range: -40°F to 248°F (-40°C to 120°C)
3. Press the ► button to accept the value and display the Program menu.

3.2. Exit Programming without Reset

Press the HOME button to leave programming mode and return to the home screen.

This completes the programming procedure for a T775P controller that does not use Reset.

4. SCHEDULING

Scheduling provides the ability to set daily temperature settings for up to two events per day. Typically, these are the daytime (setpoint) and the nighttime (setback) settings.

IMPORTANT

To enable Scheduling, you must first enter Setup mode (press and hold the **MENU** button for 5 seconds), select **OUTPUTS**, select **SCHEDULE**, and then select **YES**. See “1.3.2. SCHEDULE” on page 16.

NOTE: The T775P controller interface is intuitive. You may want to use this procedure simply as a reference to locate the particular option or parameter of interest.

NOTES:

1. If you press the **HOME** button or there is no keypad activity for four minutes, you exit Schedule mode and return to the home screen.
2. If you press the **MENU** button, you exit Schedule mode and return to the menu.

To create or change a schedule, you use the —

- **Left arrow button (◀)** to scroll backward through the Schedule menus
- **Right arrow button (▶)** to select the highlighted menu item and display its content
- **Up and Down arrow buttons (▲ and ▼)** to scroll up and down through a list of items or to increase or decrease the value of a displayed schedule parameter

Creating a Schedule

To create a schedule, perform the following in the order listed:

1. Enable Scheduling in Setup mode — see “1.3.2. SCHEDULE” on page 16.
2. Enter Schedule mode — see “4.1. Entering Schedule Mode” on page 32
3. Set the Schedule Options — see “4.2. OPTIONS” on page 32
4. Set Individual Schedules — begin with “4.3. Setting Individual Schedules” on page 33
5. Exit Schedule Mode — see “4.4. Exiting Scheduling Mode” on page 34

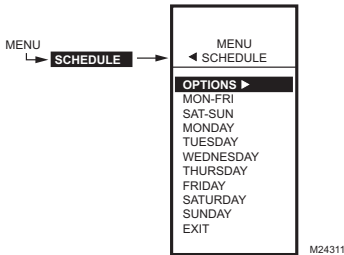

Fig. 79. Schedule - Menu.

4.1. Entering Schedule Mode

Press the MENU button, then select SCHEDULE and press the ▶ button to view the Schedule menu.

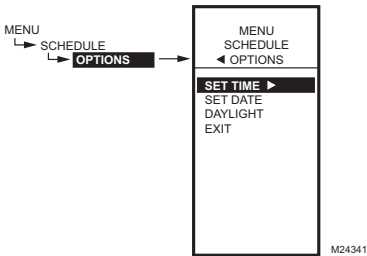

Fig. 80. Schedule - Options Menu.

4.2. OPTIONS

1. From the Schedule menu, use the ▲ and ▼ buttons to highlight OPTIONS.
2. Press the ▶ button to display the Options menu.

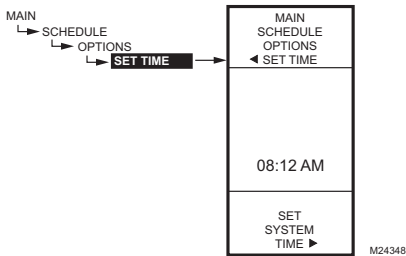

Fig. 81. Schedule - Options - System Time.

4.2.1. SET TIME

Setting the system time is required to enable the controller to follow daylight saving time.

1. From the Options menu, use the ▲ and ▼ buttons to highlight SET TIME.
2. Press the ▶ button to display the current system time setting.
3. Use the ▶ button to cycle between the hour, minute, and AM/PM values.
4. Use the ▲ and ▼ buttons to increase/decrease the desired value for the hour, minute, and AM/PM.
5. Press the ◀ button to accept the Time and return to the Options menu.

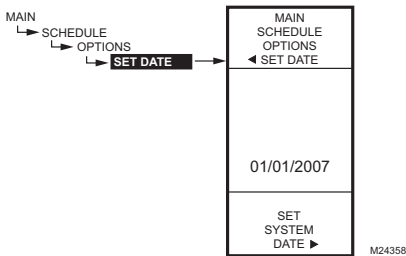

Fig. 82. Schedule - Options - System Date.

4.2.2. SET DATE

Setting the system date is required to enable the controller to follow daylight saving time.

1. From the Options menu, use the ▲ and ▼ buttons to highlight SET DATE.
2. Press the ▶ button to display the current system date setting.
3. Use the ▶ button to cycle between the month, day, and year values.
4. Use the ▲ and ▼ buttons to increase/decrease the desired value for the month, day, and year.
5. Press the ◀ button to accept the Date and return to the Options menu.

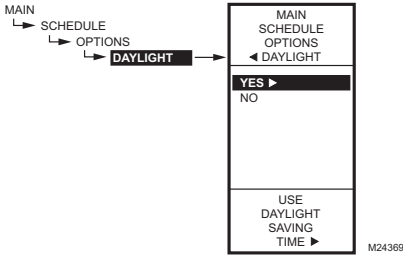

Fig. 83. Schedule - Options - Daylight Saving Time.

4.2.3. DAYLIGHT (daylight saving time)

1. From the Options menu, use the ▲ and ▼ buttons to highlight DAYLIGHT.
2. Press the ► button to display the current system setting for daylight saving time.
3. Use the ▲ and ▼ buttons to select YES or NO.
Default: YES
4. Press the ► button to accept the value and return to the Options menu.
5. From the Options menu, use the Use the ▲ and ▼ buttons to highlight EXIT.
6. Press the ► button to return to the Schedule menu.

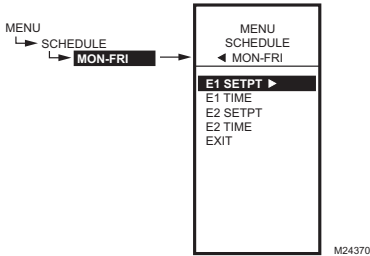

Fig. 84. Schedule Event Menu (Showing MON-FRI).

4.3. Setting Individual Schedules

As shown in the Schedule menu (Fig. 79 on page 32), schedules can be set for the following time periods:

- Monday through Friday
- Saturday and Sunday
- Individual days of the week

1. From the Schedule menu, use the ▲ and ▼ buttons to highlight the desired time period.
2. Press the ► button to display the Schedule menu for the selected time period.

For each selected time period, the schedule event (E1 and E2) parameters are exactly the same as shown in Fig. 84.

SCHEDULING EXAMPLE

Setting the schedule is independent of the temperature settings for the relay outputs. Table 5 illustrates a weekly schedule for daytime (setpoint) and night time (setback) use and shows the factory default settings.

Table 5. Mon-Fri Schedule Defaults

DAY	EVENT	SETPT ACTION	TIME
Mon-Fri	Event 1 (E1)	Setpoint	6:00 AM ^a
Mon-Fri	Event 2 (E2)	Setback	6:00 PM ^b
Sat-Sun	Not used; remains in Setback from the Mon-Fri E2 settings		

^a Setpoint time span is 6:00 AM until 5:59 PM because setback starts at 6:00 PM.

^b Setback time span is 6:00PM until 5:59 AM because setpoint starts at 6:00 AM.

To set a schedule, continue with “4.3.1. E1 SETPT (setpoint for event 1)”.

The remainder of this section shows the MON-FRI menu, but the menu selections are the same for any time period.

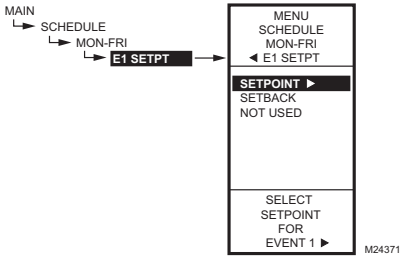

Fig. 85. Schedule - Event 1 Setpoint.

4.3.1. E1 SETPT (setpoint for event 1)

1. From the selected time period menu, use the ▲ and ▼ buttons to highlight E1 SETPT.
2. Press the ► button to display the setpoint options.
3. Use the ▲ and ▼ buttons to highlight the desired option.
4. Press the ► button to accept the value and return to the selected time period menu.

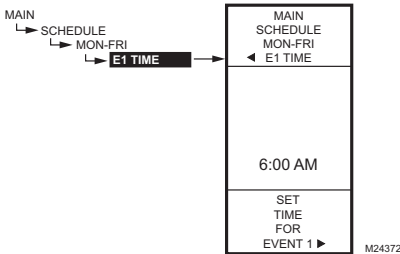

Fig. 86. Schedule - Event 1 Time.

4.3.2. E1 TIME (time for event 1)

1. From the selected time period menu, use the ▲ and ▼ buttons to highlight E1 TIME.
2. Press the ► button to display the current time setting for event 1.
3. Use the ► button to cycle between the hour, minute, and AM/PM values.
4. Use the ▲ and ▼ buttons to increase/decrease the desired value for the hour, minute, and AM/PM.
5. Press the ◀ button to accept the time and return to the selected time period menu.

4.3.3. E2 SETPOINT (setpoint for event 2)

Creating the setpoint for event 2 is accomplished the same way as the first event. See "4.3.1. E1 SETPT (setpoint for event 1)".

4.3.4. E2 TIME (time for event 2)

Creating the time for event 2 is accomplished the same way as the first event. See "4.3.2. E1 TIME (time for event 1)".

4.3.5. EXIT (exit from selected time period settings)

After entering the time for event 2, use the ◀ button to exit the schedule time period and return to the Schedule menu to select a different time period.

When you finish scheduling the time periods, continue with "4.4. Exiting Scheduling Mode".

4.4. Exiting Scheduling Mode

Press the HOME button to exit the Schedule menu and return to the home screen display.

This completes the Scheduling procedure.

SUMMARY MENU

The Summary menu provides the ability to view the schedule (E1 and E2 times) for each day of the week.

NOTE: Scheduling must be enabled for the Summary menu to display. Enabling scheduling is determined in the Setup process for the Output Options (see page 16).

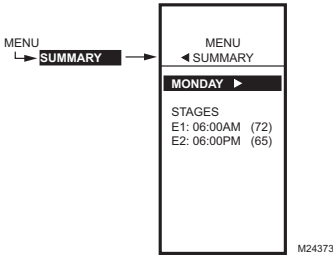

Fig. 87. Summary Example - Monday Settings.

The Summary display indicates the time and temperature (in parenthesis) for each of the two scheduled events E1 and E2, which apply to all stages.

1. Press the MENU button, then select SUMMARY and press the ► button to view the summary settings.
2. Use the ► button to scroll forward through each day of the week (Monday, Tuesday, Wednesday, Thursday, Friday, Saturday, and Sunday).

When finished, press the HOME button to return to the home display screen.

If programmed for Reset control, the Summary setpoints display as "RES" instead of a temperature value. For example, the display would show:

```

MONDAY
STAGES
E1: 06:00AM (RES) - indicating Reset
E2: 06:00PM (05) - setback/offset degrees
  
```

TROUBLESHOOTING

Power Loss

The date and time settings are retained for 24 hours after a power outage. After a power loss of more than 24 hours, the date and time settings may need to be reentered. All other settings are stored permanently.

Errors and Diagnostics

The controller provides an error message and diagnostic status as described below.

Error Message

There is a two-character error code that displays in response to controller software problems:

EE

EEPROM Failure— The values read back from the EEPROM are not the same as written into the EEPROM. This error cannot be field repaired. Replace the device.

Diagnostic Messages

There are two diagnostic messages that can display in response to sensor problems. The diagnostic codes that can flash on the display are:

--

Sensor Open or Shorted— Two dashes display when a sensor (typically temperature) is open or shorted. An open circuit is considered anything greater than 1570 ohms (greater than 300F), shorted anything less than 770 ohms (less than -73F). Which ever stages are operating with this sensor cease to control (meaning relays go to OFF and proportional outputs go to zero percent).

This message can also mean that the sensor is programmed, but not physically connected (open).

-60°F or 270°F (-51°C or 132°C) Blinking

Temperature Out of Range— The temperature display blinks when the sensed temperature range is outside of the display range, below -60°F (-51°C) or above 270°F (132°C). The displayed value remains at that displayed limit and control continues. Controller continues to function unless an open or shorted state is detected.

Blinking relay status

Relay Minimum Off Time is Active — On the home screen, each relay's indicator (■) blinks while the relay's minimum off time is active.

SPECIFICATIONS

Power: 24, 120, or 240 Vac; 50/60 Hz;
A separate earth ground is required for any power source.

Power Consumption:

- 8 VA maximum at 60 Hz
- 10 VA maximum at 50 Hz

Operating & Storage Temperature Ambient Rating:

- -40°F to 125°F (-40°C to 52°C) @ 50 Hz
- -40°F to 140°F (-40°C to 60°C) @ 60 Hz

Relative Humidity: 5% to 95% non-condensing

Digital Output (DO) Alarm:

- Alternating Current (AC):
 - 30 Vac RMS; 1.5 A steady 3 A inrush P.F. 0.45 NC
 - 20 Vac RMS; 100 mA minimum load on NO and NC contacts
- Direct Current (DC): 1 mA at 100 mV DC minimum load

NOTE: In applications requiring a gold contact signal relay, an external signal relay or additional load resistor may be needed for the digital output.

Relay Contact Output Ratings (N.O. and N.C.):

- 1/2 hp; 9.8 AFL, 58.8 ALR @ 120 Vac
- 1/2 hp; 4.9 AFL, 29.4 ALR @ 240 Vac
- 125 VA pilot duty @ 120/240 Vac
- 10A @ 24 Vac (resistive)

Automation and Control Solutions

Honeywell International Inc.
1985 Douglas Drive North
Golden Valley, MN 55422
customer.honeywell.com

Honeywell Limited-Honeywell Limitée
35 Dynamic Drive
Toronto, Ontario M1V 4Z9

® U.S. Registered Trademark
© 2007 Honeywell International Inc.
62-0256-01 M.S. 06-07



Printed in U.S.A. on recycled paper containing at least 10% post-consumer paper fibers.

DoC

Emissions Compliance

EN 55022: 2006
CISPR 22: 2006
VCCI V-3/2006.04
ICES-003, Issue 4: 2004
FCC PART 15 SUBPART B Class B Limit

Immunity Compliance

EN 61000-6-1: 2001 covering
EN 61000-4-2: 1995 + A1: 1998 + A2: 2001
EN 61000-4-3: 2002
EN 61000-4-4: 2004
EN 61000-4-5: 1995 + A1: 2001
EN 61000-4-6: 1996 + A1: 2001
EN 61000-4-8: 1993 + A1: 2001
EN 61000-4-11 2nd Ed.: 2004

Safety Compliance

UL 60730-1 and Part 2-9 for US and Canada

FCC Compliance Statement:

This equipment has been tested and found to comply with limits for a Class B digital device, pursuant to Part 15 of the FCC rules. These limits are designed to provide reasonable protection against harmful interference in residential installations. This equipment generates, uses, and can radiate radio frequency energy, and if not installed and used in accordance with the instructions, may cause harmful interference to radio communications.

However, there is no guarantee that interference will not occur in a particular installation. If this equipment does cause interference to radio or television equipment reception, which can be determined by turning the equipment off and on, the user is encouraged to try to correct the interference by one or more of the following measures:

- Reorient or relocate the receiving antenna
- Move the equipment away from the receiver
- Plug the equipment into an outlet on a circuit different from that to which the receiver is connected
- Consult the dealer or an experienced radio/television technician for additional suggestions

You are cautioned that any change or modifications to the equipment not expressly approved by the party responsible for compliance could void Your authority to operate such equipment.

This device complies with Part 15 of the FCC Rules. Operation is subjected to the following two conditions 1) this device may not cause harmful interference and 2) this device must accept any interference received, including interference that may cause undesired operation.

Honeywell