





## Advantages of TOSIBOX

- 
**Simple**  
 Build and manage secure OT infrastructure in minutes
- 
**Secure**  
 Tested & audited security
- 
**Modular**  
 Unlimited expandability and flexibility
- 
**Timeless**  
 Deals with legacy and future systems
- 
**Unique**  
 Globally patented point-to-point connection

## TOSIBOX® 670

### LTE enabled Plug & Go™ connectivity device

TOSIBOX® 670 is ideal as a main or backup internet source, where steady connection and high data throughput is necessary. The versatile connectivity options, utilized in conjunction with leading edge Cyber security technology from TOSIBOX enable diverse application scenarios. The durable aluminium alloy shell and small form factor is ideal for rugged mounting conditions.

Tosibox 600 series contains devices for all connectivity scenarios and meets the most demanding operating conditions. Bringing connectivity to those hard to reach locations has never been this easy. The node is compatible with all existing TOSIBOX products.

#### Main features

##### Performance

- High VPN throughput, end-to-end encryption between TOSIBOX devices, users and servers

##### Reliability

- Built-in global LTE modem – no external modem needed
- Cellular speeds up to 300Mbps
- Dual-SIM slots for operator redundancy allows for even more reliable connectivity
- TosiOnline™ automatic reconnection of dropped connections

##### Industrial design

- Durable aluminium alloy shell, DIN rail attachment
- Extended IP30 rating
- Operating temperature -40 °C ... +75 °C / -40 °F ... +167 °F

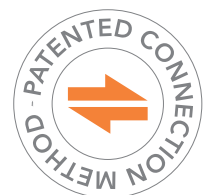

# TOSIBOX® 670 Technical Data

## Product codes

TBL670EU, TBL670UK, TBL670AU, TBL670US

## Ports

- 1 x RJ-45 WAN connection, 10/100/1000 Mb/s, auto-negotiation (MDI / MDI-X)
- 3 x RJ-45 LAN connection, 10/100/1000 Mb/s, auto-negotiation (MDI / MDI-X)
- 1 x USB 2.0, type A

## Connections

- 4 pin industrial DC power socket
- 9-50V DC, reverse polarity protection, voltage surge/transient protection
- 2 x SMA for LTE
- 1 x GNSS
- DIN rail mounting slot in the back and on both sides
- Maximum power consumption 9W

## Connection features

- 3-way WAN priority
- Proxy server support
- WAN access with static addressing or DHCP
- Network Time Protocol (NTP) server
- Automatic LAN network discovery
- LAN access with mixed static addressing and DHCP server
- Static routes
- GNSS coordinates display on UI via GPS, GLONASS, BeiDou, Galileo and QZSS
- Works in all Internet connections (operator independent)
- Firewall friendly
- Works with dynamic, static and private IP addresses
- Built-in firewall, NAT
- Up to 50 concurrent VPN connections
- VPN throughput up to 70 Mbit/s
- TosiOnline™ Automatic network recovery that recovers from most mobile operator and modem problems

## 4G Module

### TBL670US

- Region: North America and Mexico
- LTE Cat-6
- Up to 300 Mbps DL, 42 Mbps UL

### Frequency Bands

- LTE FDD: B2, B4, B5, B7, B12, B13, B25, B26, B291, B30, B66
- WCDMA: B2, B4, B5

### TBL670EU, TBL670UK, TBL670AU

- Region: EMEA/APAC/Brazil (excluding Japan)
- LTE Cat-6
- Up to 300 Mbps DL, 42 Mbps UL

### Frequency Bands

- LTE FDD: B1, B3, B5, B7, B8, B20, B28, B32
- LTE TDD: B38, B40, B41
- WCDMA: B1, B3, B5, B8

## I/O specifications

- 1 x Digital input, 0 - 6 V detected as logic low, 8 - 30 V detected as logic high
- 1 x Digital output, open collector output, max output 30 V, 300 mA
- Software configurable I/O state
- Requires separate I/O cable (TB600PAC1 or TB600PAC2)

## Included accessories

- Power supply unit
  - AC adapter - Input 100 – 240 V AC, frequency 50/60Hz 0,6A, Output 12.0 V, 1.5 A, max 18 W
- 2 x LTE antennas (swivel, SMA male)
- 1 x GNSS antenna (adhesive, SMA male, 3 m cable)
- SIM Adapter kit
- Ethernet cable (1.5 m)
- DIN rail mount

## Physical properties

- 115 mm x 44.2 mm x 95.1 mm / 4.52" x 1.74" x 3.74" (W x H x L)
- Protection class IP30
- Weight 455 g / 1.00 lbs (net weight article)
- Storage temperature -40 °C ... +75 °C / -40 °F ... +167 °F
- Operating temperature -40 °C ... +75 °C / -40 °F ... +167 °F

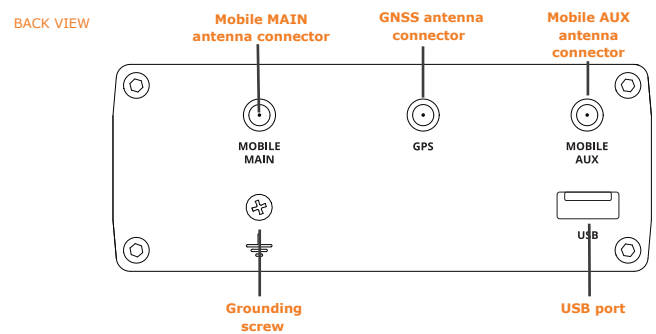
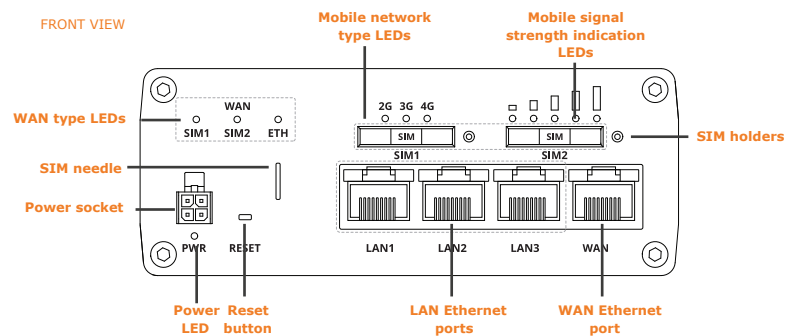

Power socket pinout

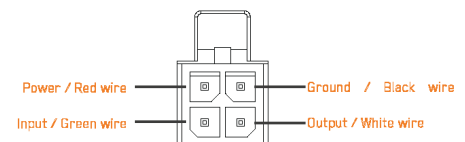

Tosibox Oy

sales@tosibox.com

support@tosibox.com

Sales, international, tel. +358 44 70 90 200

www.tosibox.com



# TOSIBOX