

 **IDEC SmartRelay**  
**User's Manual**

## Legal information

### Warning notice system

This manual contains notices you have to observe in order to ensure your personal safety, as well as to prevent damage to property. The notices referring to your personal safety are highlighted in the manual by a safety alert symbol, notices referring only to property damage have no safety alert symbol. These notices shown below are graded according to the degree of danger.

<b>⚠ DANGER</b>
indicates that death or severe personal injury <b>will</b> result if proper precautions are not taken.
<b>⚠ WARNING</b>
indicates that death or severe personal injury <b>may</b> result if proper precautions are not taken.
<b>⚠ CAUTION</b>
indicates that minor personal injury can result if proper precautions are not taken.
<b>NOTICE</b>
indicates that property damage can result if proper precautions are not taken.

If more than one degree of danger is present, the warning notice representing the highest degree of danger will be used. A notice warning of injury to persons with a safety alert symbol may also include a warning relating to property damage.

### Qualified Personnel

The product/system described in this documentation may be operated only by **personnel qualified** for the specific task in accordance with the relevant documentation, in particular its warning notices and safety instructions. Qualified personnel are those who, based on their training and experience, are capable of identifying risks and avoiding potential hazards when working with these products/systems.

### Proper use of IDEC products

Note the following:

<b>⚠ WARNING</b>
IDEC products may only be used for the applications described in the catalog and in the relevant technical documentation. If products and components from other manufacturers are used, these must be recommended or approved by IDEC. Proper transport, storage, installation, assembly, commissioning, operation and maintenance are required to ensure that the products operate safely and without any problems. The permissible ambient conditions must be complied with. The information in the relevant documentation must be observed.

### Copyright © IDEC CORPORATION All rights reserved

The reproduction, distribution or use of this document or its contents is not permitted without express written authority. Offenders will be liable for damages. All rights reserved, in particular in the event of patents being granted or the registration of a utility model or design.

### Disclaimer of Liability

We have reviewed the contents of this publication to ensure consistency with the hardware and software described. Since variance cannot be precluded entirely, we cannot guarantee full consistency. However, the information in this publication is reviewed regularly and any necessary corrections are included in subsequent editions.

# Preface

With IDEC SmartRelay you have acquired a logic module that meets the stringent quality requirements of ISO 9001.

You can use IDEC SmartRelay in many fields of applications. Due to its high functionality and easy operation, IDEC SmartRelay offers you the utmost efficiency for almost any application.

## Purpose of this manual

This IDEC SmartRelay manual provides you with information about the creation of circuit programs, about the installation and use of Base Modules with more enhanced features, the FL1F-RD1 (Text Display with Ethernet interfaces), and IDEC SmartRelay expansion modules.

For FL1F series, WindLGC uses device type to distinguish different IDEC SmartRelay device. For more information, you can refer to the following table.

Device	Device type in WindLGC	WindLGC Version
SmartRelay Base Module (FL1F-H12RC*, FL1F-B12RC*)	SmartRelay FL1F	WindLGC V8.0
	SmartRelay FL1F FS5	WindLGC V8.2
Text Display (FL1F-RD1)	SmartRelay TDE	WindLGC V8.0
	SmartRelay TDE FS4	WindLGC V8.2

## IEDEC SmartRelay's place in information technology

The wiring information in your IDEC SmartRelay manual is also found in the IDEC SmartRelay Product Info included with all devices. For further information on programming the IDEC SmartRelay on your PC, refer to the Online Help for WindLGC.

WindLGC is IDEC SmartRelay programming software for PCs. It runs under Windows® (including Windows XP®, Windows 7®, Windows 8® and Windows 10®). It helps you to get started with IDEC SmartRelay and to write, test, print out and archive your programs, independent of IDEC SmartRelay.

## Guide

The manual contains the following chapters:

- Getting started with IDEC SmartRelay
- IDEC SmartRelay installation and wiring
- Programming IDEC SmartRelay
- IDEC SmartRelay functions
- Web server
- UDF (User-Defined Function)
- Data Log
- Configuring IDEC SmartRelay
- Using memory cards
- Security
- IDEC SmartRelay software
- Applications

The manual also includes appendices A - F, which follow the chapters.

## Valid range of this manual

The manual applies to devices of IDEC SmartRelay FL1F FS5.

## New features of IDEC SmartRelay FL1F FS5 device series

The following features are new for IDEC SmartRelay FL1F FS5 devices:

- **Support the function that TDE can be scanned**  
IDEC SmartRelay TDE FS4 can be scanned by WindLGC V8.2.
- **Support FL1F Web Editor tool**  
FL1F Web Editor is a new tool used together with IDEC SmartRelay Base Module (BM) and WindLGC. This tool helps you create user-defined web pages in the Editor pane, and visit the whole project through Web Server of IDEC SmartRelay Base Module. With FL1F Web Editor, you can also integrate different components including some variables conveniently. For detailed information, refer to *FL1F Web Editor Tool Online Help*.
- **Support function block parameters automatic storage**  
The modification for function block parameters can be saved to SD card automatically.
- **Support Modbus protocol on Ethernet TCP/IP networks**  
IDEC SmartRelay supports both Modbus Server functions and Modbus Client functions. Modbus modules share connections with FL1F modules. IDEC SmartRelay has separated connection pools for server and client. Each connection in server pool can be used for FL1F Server or Modbus Server. There is no limitation and reservation for any server. This means FL1F server cannot access if all server connections are occupied by Modbus Server. It is also the same case for client connection pool. Refer to FL1F sections for detailed information about server/client connection.
- **Support wider ambient temperature range**  
IDEC SmartRelay BM and EM modules can support wider ambient temperature range, and the ambient temperature is widen to -20 °C to 55 °C.
- **Support Network Time Protocol (NTP) function for time and data synchronization**  
An NTP client can synchronize time from an NTP server. FL1F FS5 BM can serve as both an NTP server and an NTP client at the same time. The NTP function of IDEC SmartRelay BM is disabled by default. You can enable it on the BM/TDE menu or WindLGC.
- **Support FL1F Access Tool**  
IDEC provides a new tool, FL1F Access Tool, to view and trace the variables in IDEC SmartRelay Base module. You can also save the log files of the traced variables with this tool. For detailed information, refer to *FL1F Access Tool Help*.

## New features of the IDEC SmartRelay FL1F

The following features are new for the IDEC SmartRelay FL1F devices:

- **Ethernet communication support by all Base Modules**  
Each Base Module is equipped with an RJ45 interface and a two-color status LED for Ethernet communication.

- **New text display (FL1F-RD1) with enhanced features**

- The Text Display module is available with two Ethernet interfaces. These two Ethernet interfaces can also function as a two-port switcher. You can connect the Text Display with a Base Module, a PC, or another Text Display through the Ethernet interfaces. Text Display can connect with different Base Modules through IP address selection.
- Text Display provides a three-pin (P1, P2, and FE) terminal for power connection.
- Text Display has three main menu commands available, respectively for the IP address selection of a Base Module, the remote settings of the connected Base Module, and the independent configuration of the Text Display.

- **Support of 6-line display and three backlight colors**

Both the IDEC SmartRelay onboard display and Text Display support a 6-line character display and three backlight colors (white/amber/red). The IDEC SmartRelay onboard display can display a maximum of 16 Western European characters or 8 Asian characters per line. Text Display can display a maximum of 20 Western European characters or 10 Asian characters per line.

- **Increased maximum I/O connections**

IDEC SmartRelay supports a maximum of 24 digital inputs, 20 digital outputs, 8 analog inputs and 8 analog outputs.

- **Built-in Web server in Base Modules**

IDEC SmartRelay provides you with easy access through Internet browsers. With the Web server function, you can access the Base Module using a connected device (PC, tablet or smart phone) by entering the IP address of the IDEC SmartRelay module in the Web browser of the connected device.

- **Enhanced functions added to special function blocks**

- **Message texts:** The IDEC SmartRelay support a 6-line message text display and ticking messages, as well as message text display on the Web server. You can enable the tick setting for each display line by setting the block parameters.

- **More memory markers for the creation of the circuit program**

The IDEC SmartRelay supports 64 digital memory markers and 64 analog memory markers. Some new special markers are described as follows:

- M28: Enables the Display amber backlight
- M29: Enables the Display red backlight
- M30: Enables the Text Display amber backlight
- M31: Enables the Text Display red backlight

- **Extended menu commands for diagnostics**

With the extended menu commands for diagnostics, the IDEC SmartRelay provides a facility for diagnosing software and hardware errors and viewing the error logs. You can use these menu commands to troubleshoot and debug the IDEC SmartRelay system.

- **Curve representation of analog value changes**

IDEC SmartRelay supports the graphical display of analog value changes in the form of a trend curve on the onboard display. You can easily monitor each analog I/O in use by means of the trend curves when IDEC SmartRelay is in RUN mode.

- **Micro SD card support**

IDEC SmartRelay supports micro SD (Secure Digital) cards that support FAT32 file system format. You can store and copy-protect a circuit program, with or without the data log of process data, from IDEC SmartRelay to an SD card, or copy a circuit program from the card to IDEC SmartRelay. The maximum capacity of micro SD card is 32 GB.

- **Enhanced Data Log function**

IDEC SmartRelay supports a maximum of 20000 lines for each data log file stored on the micro SD card. IDEC SmartRelay automatically creates a new data log file with a new name on the micro SD card when the number of lines in the current file exceeds the maximum number of lines.

## **Compatibility with previous IDEC SmartRelay series**

IDEC SmartRelay device series are incompatible with any previous device series such as FL1E series.

WindLGC version 8.0 or later is required to use IDEC SmartRelay FL1F. IDEC SmartRelay FL1F cannot be programmed with WindLGC prior than version 8.0.

The circuit programs used with prior versions of IDEC SmartRelay, such as IDEC SmartRelay FL1E, can be transferred to IDEC SmartRelay FL1F using WindLGC.

## **Security information**

IDEC provides products and solutions with industrial security functions that support the secure operation of plants, systems, machines and networks.

In order to protect plants, systems, machines and networks against cyber threats, it is necessary to implement – and continuously maintain – a holistic, state-of-the-art industrial security concept.

Customers are responsible for preventing unauthorized access to their plants, systems, machines and networks. Such systems, machines and components should only be connected to an enterprise network or the internet if and to the extent such a connection is necessary and only when appropriate security measures (e.g. firewalls and/or network segmentation) are in place.

IDEC's products and solutions undergo continuous development to make them more secure. IDEC strongly recommends that product updates are applied as soon as they are available and that the latest product versions are used. Use of product versions that are no longer supported, and failure to apply the latest updates may increase customers' exposure to cyber threats.

---

### **Note**

To protect WindLGC from any undesired manipulation when your PC suffers malicious attacks from the Internet, IDEC strongly recommends you to install a whitelist tool such as McAfee Application Control 6.1 on the PC.

---



# Table of contents

	Preface.....	ii
<b>1</b>	<b>Getting started with IDEC SmartRelay .....</b>	<b>1</b>
<b>2</b>	<b>IEDEC SmartRelay installation and wiring .....</b>	<b>13</b>
2.1	Modular IDEC SmartRelay setup .....	15
2.1.1	Maximum IDEC SmartRelay network setup .....	15
2.1.2	Maximum setup with expansion modules .....	17
2.1.3	Setup with different voltage classes .....	18
2.1.4	Compatibility .....	19
2.2	Installing/removing IDEC SmartRelay .....	20
2.2.1	DIN rail mounting .....	21
2.2.2	Wall-mounting .....	23
2.2.3	Mounting the Text Display .....	25
2.2.4	Labeling IDEC SmartRelay .....	26
2.3	Wiring IDEC SmartRelay .....	26
2.3.1	Connecting the power supply .....	27
2.3.2	Connecting the Text Display power supply .....	29
2.3.3	Connecting IDEC SmartRelay inputs .....	29
2.3.4	Connecting outputs .....	39
2.3.5	Connecting the Ethernet interface .....	43
2.4	Putting into operation.....	44
2.4.1	Powering on IDEC SmartRelay .....	44
2.4.2	Operating states .....	47
<b>3</b>	<b>Programming IDEC SmartRelay .....</b>	<b>49</b>
3.1	Connectors .....	50
3.2	Blocks and block numbers.....	52
3.3	From circuit diagram to IDEC SmartRelay program .....	55
3.4	The four golden rules for operating IDEC SmartRelay .....	57
3.5	Configuring menu access protection for IDEC SmartRelay.....	59
3.6	Overview of IDEC SmartRelay menus .....	61
3.7	Writing and starting the circuit program.....	63
3.7.1	Selecting programming mode .....	63
3.7.2	The first circuit program .....	64
3.7.3	Circuit program input .....	65
3.7.4	Assigning a circuit program name .....	69
3.7.5	Password for circuit program protection .....	70
3.7.6	Switching IDEC SmartRelay to RUN mode .....	74
3.7.7	Second circuit program .....	78
3.7.8	Deleting a block .....	83
3.7.9	Deleting block groups .....	84
3.7.10	Correcting programming errors .....	86
3.7.11	Selecting analog output values for RUN/STOP transition .....	86
3.7.12	Defining the type of analog outputs .....	88
3.7.13	Setting the power-on delay of IDEC SmartRelay .....	89
3.7.14	Clearing the circuit program and password .....	89



3.7.15	Summertime/wintertime conversion .....	90
3.7.16	Network Time Protocol (FL1F FS5 and later versions only) .....	94
3.8	Configuring additional functions for IDEC SmartRelay .....	96
3.8.1	Configuring network settings .....	97
3.8.2	Configuring a UDF (User-Defined Function) .....	98
3.8.3	Configuring the Data Log .....	98
3.8.4	Viewing network inputs/outputs .....	99
3.8.5	Changing IDEC SmartRelay to master/slave mode .....	100
3.8.6	Diagnosing errors from IDEC SmartRelay .....	102
3.9	Memory space and circuit program size .....	107
<b>4</b>	<b>IDEC SmartRelay functions .....</b>	<b>113</b>
4.1	Constants and connectors .....	113
4.2	Basic functions list - GF .....	118
4.2.1	AND .....	119
4.2.2	AND with edge detection .....	120
4.2.3	NAND (not AND) .....	120
4.2.4	NAND with edge detection .....	121
4.2.5	OR .....	122
4.2.6	NOR (not OR) .....	123
4.2.7	XOR (exclusive OR) .....	124
4.2.8	NOT (Negation, Inverter) .....	124
4.3	Special functions.....	125
4.3.1	Designation of the inputs .....	125
4.3.2	Time response .....	126
4.3.3	Backup of the real-time clock .....	127
4.3.4	Retentivity .....	127
4.3.5	Parameter protection .....	127
4.3.6	Calculating the gain and offset of analog values .....	128
4.4	Special functions list - SF .....	129
4.4.1	On-delay .....	134
4.4.2	Off-delay .....	137
4.4.3	On-/off-delay .....	139
4.4.4	Retentive on-delay .....	141
4.4.5	Interval time-delay relay/Pulse output .....	143
4.4.6	Edge-triggered interval time-delay relay .....	145
4.4.7	Asynchronous pulse generator .....	147
4.4.8	Random generator .....	149
4.4.9	Stairwell light switch .....	151
4.4.10	Dual-function switch .....	153
4.4.11	Seven-day time switch .....	156
4.4.12	Twelve-month time switch .....	159
4.4.13	Astronomical clock .....	164
4.4.14	Stopwatch .....	167
4.4.15	Up/down counter .....	169
4.4.16	Operating hours counter .....	172
4.4.17	Frequency trigger .....	176
4.4.18	Analog trigger .....	179
4.4.19	Analog differential trigger .....	182
4.4.20	Analog comparator .....	184
4.4.21	Analog watchdog .....	189
4.4.22	Analog amplifier .....	192
4.4.23	Latching relay .....	194
4.4.24	Current impulse relay .....	195

4.4.25	Message texts .....	197
4.4.26	Softkey .....	206
4.4.27	Shift register .....	208
4.4.28	Analog multiplexer .....	210
4.4.29	Analog ramp control .....	213
4.4.30	PI controller .....	217
4.4.31	Pulse width modulator (PWM) .....	222
4.4.32	Analog Math .....	225
4.4.33	Analog Math error detection .....	228
4.4.34	Analog filter .....	230
4.4.35	Max/Min .....	232
4.4.36	Average value .....	236
4.4.37	Float/Integer Converter .....	238
4.4.38	Integer/Float Converter .....	240
<b>5</b>	<b>Web server .....</b>	<b>243</b>
5.1	Enabling the Web server .....	243
5.2	Logging on to the Web server .....	244
5.3	Viewing IDEC SmartRelay system information .....	246
5.4	Operating the virtual module on the Web server .....	246
5.5	Viewing and editing variable memory tables .....	251
5.6	Logging off from the Web server .....	251
<b>6</b>	<b>UDF (User-Defined Function) .....</b>	<b>253</b>
<b>7</b>	<b>Data log .....</b>	<b>257</b>
<b>8</b>	<b>Configuring IDEC SmartRelay .....</b>	<b>259</b>
8.1	Selecting parameter assignment mode .....	259
8.1.1	Parameters .....	261
8.1.2	Selecting the parameters .....	261
8.1.3	Modifying parameters .....	262
8.2	Setting the default values for IDEC SmartRelay .....	264
8.2.1	Setting the time of day and date .....	265
8.2.2	Setting the display contrast and backlight choice .....	267
8.2.3	Setting the menu language .....	269
8.2.4	Setting the number of AIs in IDEC SmartRelay .....	270
8.2.5	Setting the start screen .....	271
<b>9</b>	<b>Using memory cards .....</b>	<b>273</b>
9.1	Formatting micro SD cards .....	273
9.2	Inserting and removing the card from IDEC SmartRelay .....	275
9.3	Copying data from IDEC SmartRelay to the card .....	276
9.4	Copying data from the card to IDEC SmartRelay .....	278
<b>10</b>	<b>Security .....</b>	<b>281</b>
10.1	Network security .....	281
10.2	Program access security .....	284
10.2.1	Program password protection .....	284
10.2.2	Program copy protection .....	284
10.3	Menu access security .....	286

<b>11</b>	<b>IEDEC SmartRelay software .....</b>	<b>287</b>
11.1	IEDEC SmartRelay software.....	287
11.2	Connecting IDEC SmartRelay to a PC.....	290
<b>12</b>	<b>Applications .....</b>	<b>291</b>
<b>A</b>	<b>Technical data .....</b>	<b>293</b>
A.1	General technical data.....	293
A.2	Technical data: FL1F-B12RCC/H12RCC .....	295
A.3	Technical data: FL1F-M08C2R2.....	297
A.4	Technical data: FL1F-H12SCD.....	299
A.5	Technical data: FL1F-M08B1S2.....	300
A.6	Technical data: FL1F-H12RCA/B12RCA.....	302
A.7	Technical data: FL1F-M08D2R2.....	304
A.8	Technical data: FL1F-B12RCE/H12RCE, FL1F-M08B2R2.....	306
A.9	Switching capacity/service life of the relay outputs.....	308
A.10	Technical data: FL1F-J2B2.....	309
A.11	Technical data: FL1F-K2BM2.....	310
A.12	Technical data: IDEC SmartRelay Power 24 V .....	311
A.13	Technical data: FL1F-RD1 (Text Display with Ethernet interfaces).....	311
<b>B</b>	<b>Determining the cycle time .....</b>	<b>313</b>
<b>C</b>	<b>IEDEC SmartRelay without display ("IEDEC SmartRelay Pure") .....</b>	<b>315</b>
<b>D</b>	<b>IEDEC SmartRelay menu structure .....</b>	<b>317</b>
D.1	Base Module.....	317
D.1.1	Menu overview .....	317
D.1.2	Main menu .....	317
D.1.3	Programming menu .....	318
D.1.4	Card menu .....	318
D.1.5	Setup menu .....	319
D.1.6	Network menu .....	320
D.1.7	Diagnostics menu .....	320
D.1.8	Start menu .....	321
D.2	Text Display.....	322
D.2.1	Menu overview .....	322
D.2.2	Main menu .....	323
D.2.3	BM selection menu .....	324
D.2.4	BM settings menu .....	324
D.2.5	Text Display settings menu .....	326
<b>E</b>	<b>Type numbers .....</b>	<b>329</b>
<b>F</b>	<b>Abbreviations .....</b>	<b>331</b>

# Getting started with IDEC SmartRelay

# 1

## Here's IDEC SmartRelay

IDEC SmartRelay is a universal logic module made by IDEC that integrates:

- Controls
- Operator and display panel with background lighting
- Power supply
- Interface for expansion modules
- Interface for a micro SD card
- Interface for an optional text display (TDE) module
- Pre-configured standard functions, for example, on- and off-delays, current impulse relay and softkey
- Timers
- Digital and analog memory markers
- Inputs and outputs, according to the device type

IDEC SmartRelay additionally integrates the following components:

- Interfaces for Ethernet communication
- FE (Functional Earth) terminal for connecting to earth ground
- One LED for indicating Ethernet communication status

## What IDEC SmartRelay can do for you

IDEC SmartRelay offers solutions for domestic and installation engineering applications such as stairwell lighting, external lighting, sun blinds, shutters, shop window lighting and more. It can also offer solutions for switch cabinet engineering, as well as for mechanical and apparatus engineering such as gate control systems, air-conditioning systems, and rainwater pumps.

You can also use IDEC SmartRelay to implement special control systems in conservatories or greenhouses, for control signal processing and for distributed local controlling of machines and processes.

Special versions without operator panel and display unit are available for series production applications in installation engineering.

## Which devices are available?

Base Modules are available in two voltage classes:

- Class 1  $\leq 24$  V, i.e. 12 VDC, 24 VDC, 24 VAC
- Class 2  $> 24$  V, i.e. 100 VAC/VDC to 240 VAC/VDC

Base Modules are available in two versions:

- Base Modules (version with display): 8 inputs and 4 outputs
- Base Modules (version without display): 8 inputs and 4 outputs

Each module has an expansion interface and an Ethernet interface and provides 44 pre-configured standard and special function blocks for the creation of your circuit program.

## Which expansion modules are available?

- FL1F-M08... digital modules are available for operation with 12 VDC, 24 VAC/VDC and 100 VAC/VDC to 240 VAC/VDC, and are equipped with four inputs and four outputs.
- IDEC SmartRelay analog modules are available for operation with 24 VDC and some with 12 VDC, depending on the specific module. Each is equipped with two analog inputs or two analog outputs.

Each digital/analog module has two expansion interfaces for connecting additional modules.

## Which display modules are available?

- Base Modules
- Text Display

## Features of the Text Display

The Text Display is available for the Base Modules. It provides an additional display that is wider than the Base Module. It has four function keys that you can program in your circuit program as inputs. Like the IDEC Base Module, it has four cursor keys, an ESC key and an Enter key that you can also program in your circuit program and use for navigation on the Text Display.

You can create and download a power-up screen for the Text Display from WindLGC. This screen displays briefly when you initially power on the Text Display. You can also upload the power-up screen from the Text Display to WindLGC.

The Text Display provides three main menu commands, respectively for the IP address selection of a Base Module, the remote settings of the connected Base Module, and the independent configuration of the Text Display. The menus for the Text Display are shown in Appendix "Text Display (Page 322)".

IDEC SmartRelay TDE FS4 can be scanned by WindLGC V8.2.

## It's your choice

The various Base Modules, expansion modules, and Text Display offer you a highly flexible and adaptive system to suit your specific tasks.

The IDEC SmartRelay system offers you many solutions for small domestic installations, simple automation tasks, and even complex engineering tasks involving its integration into a bus system.

---

### Note

You can only use expansion modules of the same voltage as the Base Module. Mechanical encoding pins in the housing prevent you from connecting devices of a different voltage class.

Exception: The interface on the left side of an analog module is galvanically isolated. These types of expansion modules can therefore be connected to devices of a Setup with different voltage classes (Page 18).

A Text Display has two Ethernet interfaces. You can connect each interface to a Base Module, a PC, or another Text Display.

Each Base Module supports the following connections for the creation of the circuit program, regardless of the number of connected modules:

- Digital inputs I1 to I24
- Analog inputs AI1 to AI8
- Digital outputs Q1 to Q20
- Analog outputs AQ1 to AQ8
- Digital memory markers blocks M1 to M64:
  - M8: Startup marker (Displays blue in WindLGC V8.2)
  - M25: Backlight marker: onboard display white
  - M26: Backlight marker: Text Display white
  - M27: Message text character set marker (Displays green in WindLGC V8.2)
  - M28: Backlight marker: onboard display amber
  - M29: Backlight marker: onboard display red
  - M30: Backlight marker: Text Display amber
  - M31: Backlight marker: Text Display red
- Analog memory markers blocks: AM1 to AM64
- Shift register bits: S1.1 to S4.8 (32 shift register bits)
- 4 cursor keys
- Blank outputs: X1 to X64

IDEC SmartRelay additionally supports the display of the following network digital/analog inputs and outputs if you have previously configured them in the circuit program in WindLGC V8.0 and downloaded the program to the IDEC SmartRelay:

- 64 network digital inputs: NI1 to NI64
  - 32 network analog inputs: NAI1 to NAI32
  - 64 network digital outputs: NQ1 to NQ64
  - 16 network analog outputs: NAQ1 to NAQ16
-

## The IDEC SmartRelay structure

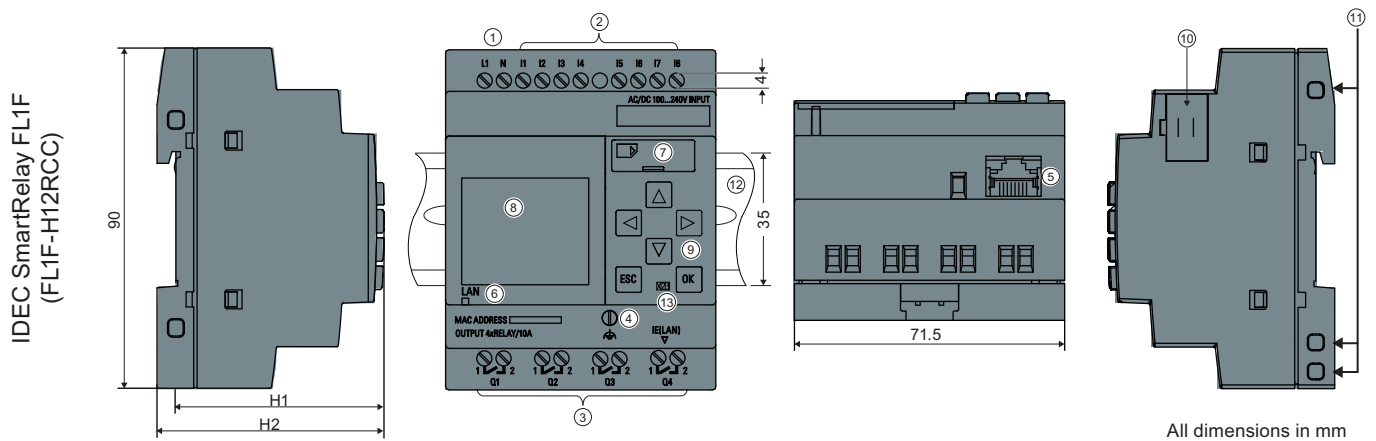

- ① Power supply
- ② Inputs
- ③ Outputs
- ④ FE terminal
- ⑤ RJ45 interface, for connection to Ethernet (10/100 Mbit/s)
- ⑥ Ethernet communication status LED
- ⑦ Micro SD card slot
- ⑧ LCD (only for version with display) (Note 1)
- ⑨ Control panel (only for version with display)
- ⑩ Expansion interface
- ⑪ Mechanical coding sockets
- ⑫ Standard DIN rail
- ⑬ Version number  
(Example: 

X	2	3
---	---	---

 represents Version 1.)

H1: Version with display: 55 mm  
Version without display: 53 mm

H2: Version with display: 60 mm  
Version without display: 58 mm

Note 1: For version without display, LCD is replaced by RUN/STOP LED.

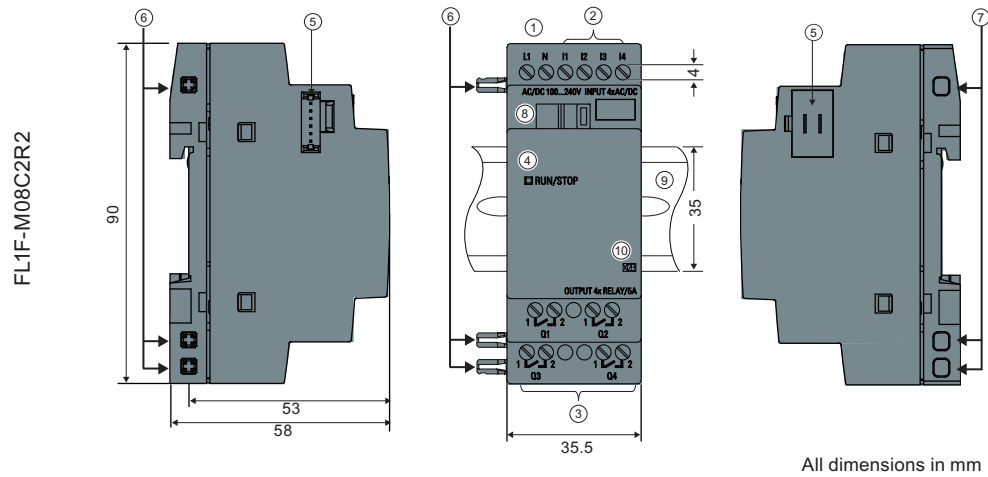

- |                             |                          |
|-----------------------------|--------------------------|
| ① Power supply              | ② Inputs                 |
| ③ Outputs                   | ④ RUN/STOP LED           |
| ⑤ Expansion interface       | ⑥ Mechanical coding pins |
| ⑦ Mechanical coding sockets | ⑧ Slide                  |
| ⑨ Standard DIN rail         | ⑩ Version number         |

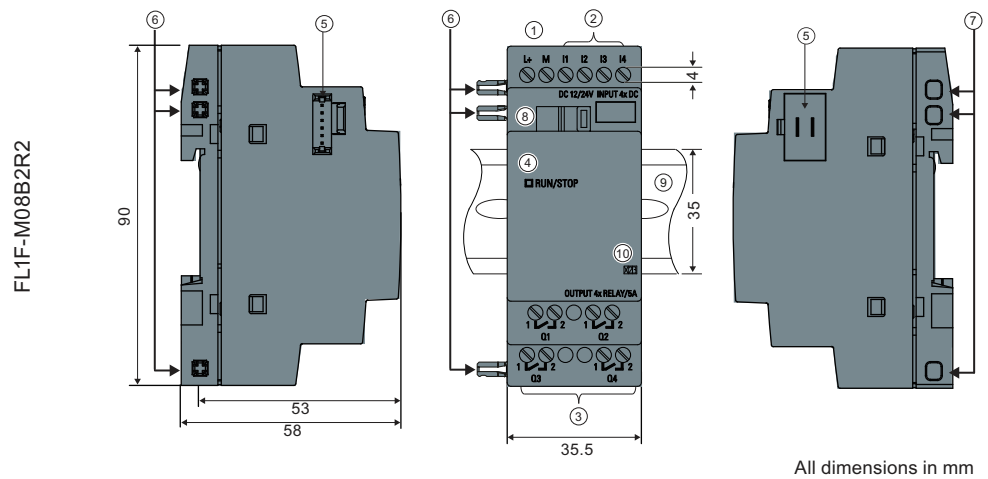

- |                             |                          |
|-----------------------------|--------------------------|
| ① Power supply              | ② Inputs                 |
| ③ Outputs                   | ④ RUN/STOP LED           |
| ⑤ Expansion interface       | ⑥ Mechanical coding pins |
| ⑦ Mechanical coding sockets | ⑧ Slide                  |
| ⑨ Standard DIN rail         | ⑩ Version number         |



**FL1F-J2B2**

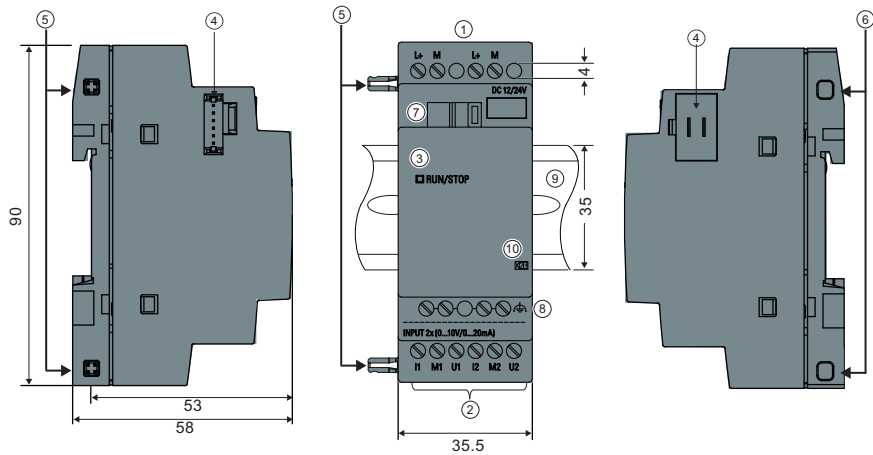

All dimensions in mm

- |                          |                             |
|--------------------------|-----------------------------|
| ① Power supply           | ② Inputs                    |
| ③ RUN/STOP LED           | ④ Expansion interface       |
| ⑤ Mechanical coding pins | ⑥ Mechanical coding sockets |
| ⑦ Slide                  | ⑧ FE terminal               |
| ⑨ Standard DIN rail      | ⑩ Version number            |

**FL1F-K2BM2 (0 ... 10 VDC or 0/4 ... 20 mA)**

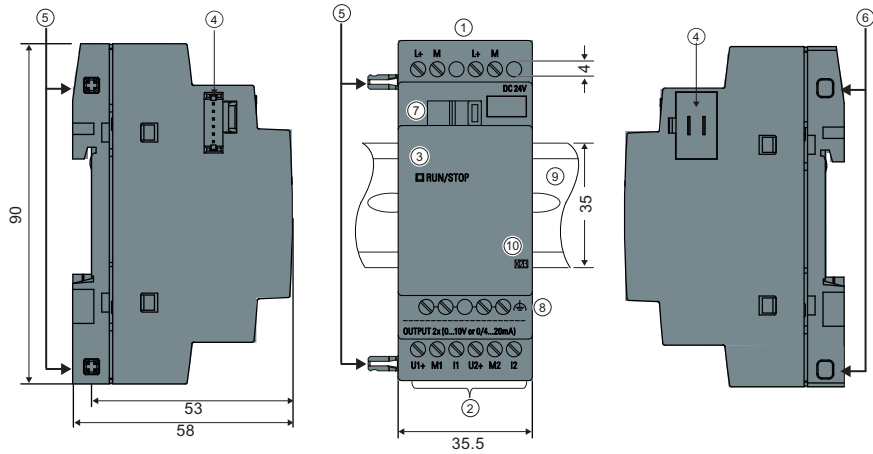

All dimensions in mm

- |                          |                             |
|--------------------------|-----------------------------|
| ① Power supply           | ② Outputs                   |
| ③ RUN/STOP LED           | ④ Expansion interface       |
| ⑤ Mechanical coding pins | ⑥ Mechanical coding sockets |
| ⑦ Slide                  | ⑧ FE terminal               |
| ⑨ Standard DIN rail      | ⑩ Version number            |

## FL1F-RD1

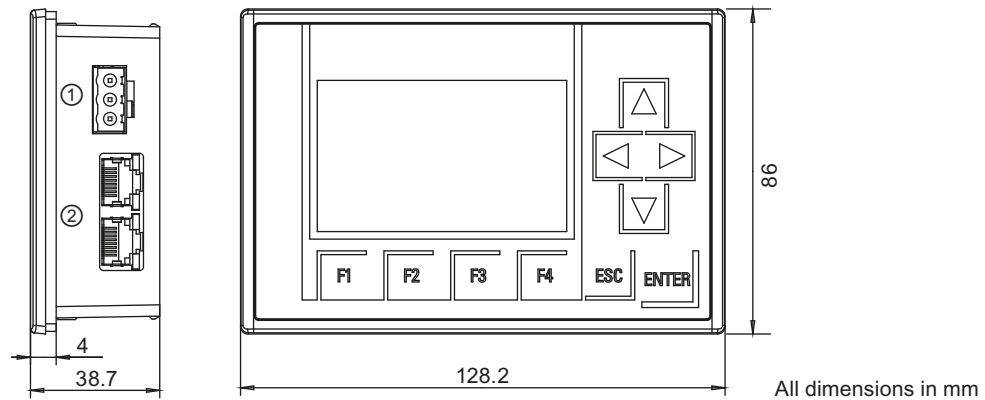

- ① Power supply
- ② Ethernet interfaces

The Text Display includes a wider display area than onboard display. It includes four programmable cursor keys, four programmable function keys, an ESC key, and an ENTER key. You use the Ethernet cable to connect from the Ethernet interface on the right side of the Text Display to the Ethernet interface on the Base Module.

### How to identify the IDEC SmartRelay

The IDEC SmartRelay identifier informs you of various properties.

Base module

FL1F- ①②③④⑤

① B: Base module without display

H: Base module with display

② Number of Inputs and Outputs

③ R: Relay output

S: Tr. (source) output

④ C: With clock

⑤ D: 24V DC

E: 12/24V DC

A: 24V AC/DC

C: 100...240V AC/DC

Expansion module

Digital module

FL1F-M ①②③④

① Number of Inputs and Outputs

② B1: 24V DC B2: 12/24V DC

C2: 100...240V AC/DC D2: 24V AC/DC

③ S: Tr. (source) output R: Relay output

④ Terminal type 2: non-removable terminal

Analog input module

FL1F-J ①②③

- ① Number of Inputs
- ② Resolution B: 10bit
- ③ Terminal type 2: non-removable terminal

Analog output module

FL1F-K ①②③④

- ① Number of Outputs
- ② Resolution B: 10bit
- ③ M: 0 ... 10V, 0/4 ... 20 mA
- ④ Terminal type 2: non-removable terminal

Text Display

FL1F- ①②

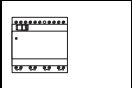
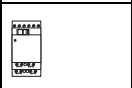
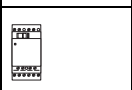
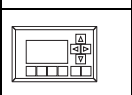

- ① RD: Remote Display
- ② Version type

## Symbols

	Version with display unit is equipped with 8 inputs, 4 outputs and 1 Ethernet interface.
	Version without display unit is equipped with 8 inputs, 4 outputs and 1 Ethernet interface.
	The digital module is equipped with 4 digital inputs and 4 digital outputs.
	The analog module is equipped with 2 analog inputs or 2 analog outputs, according to the device type.
	The Text Display module is equipped with 2 Ethernet interfaces.

## Versions



The following IDEC SmartRelay versions are available:

Symbol	Designation	Supply voltage	Inputs	Outputs	Properties
	FL1F-H12RCE	12/24VDC	8 digital <sup>1)</sup>	4 relays (10 A)	
	FL1F-H12RCC	100 VAC/VDC to 240 VAC/VDC	8 digital	4 relays (10 A)	
	FL1F-H12SCD	24 VDC	8 digital <sup>1)</sup>	4 solid state 24 V/0.3 A	
	FL1F-H12RCA <sup>3)</sup>	24 VAC/VDC	8 digital	4 relays (10 A)	
	FL1F-B12RCE	12/24 VDC	8 digital <sup>1)</sup>	4 relays (10 A)	no display unit no keyboard
	FL1F-B12RCA <sup>3)</sup>	24 VAC/VDC	8 digital	4 relays (10 A)	no display unit no keyboard
	FL1F-B12RCC <sup>2)</sup>	100 VAC/VDC to 240 VAC/VDC	8 digital	4 relays (10 A)	no display unit no keyboard

- <sup>1)</sup> Of those can be used alternatively: 4 analog inputs (0 V to 10 V) and 4 fast digital inputs.
- <sup>2)</sup> 100-240 VAC/VDC versions: AC input group has two groups consisting of 4 inputs each. Each input within a group must be connected to the same phase. It is possible to interconnect groups with a different phase.
- <sup>3)</sup> The digital inputs can be operated with P or N action.

## Expansion modules

The following expansion modules can be connected to IDEC SmartRelay:

Symbol	Name	Power supply	Inputs	Outputs
	FL1F-M08B2R2	12/24 VDC	4 digital	4 relays (5 A)
	FL1F-M08B1S2	24 VDC	4 digital	4 solid state 24 V/0.3 A
	FL1F-M08D2R2 <sup>3)</sup>	24 VAC/VDC	4 digital	4 relays (5 A)
	FL1F-M08C2R2	100 VAC/VDC to 240 VAC/VDC	4 digital <sup>1)</sup>	4 relays (5 A)
	FL1F-J2B2	12/24 VDC	2 analog 0 V to 10 V or 0/4 mA to 20 mA <sup>2)</sup>	None
	FL1F-K2BM2	24 VDC	None	2 analog 0 VDC to 10 VDC or 0/4 mA to 20 mA <sup>4)</sup>

- <sup>1)</sup> Different phases are not allowed within the inputs.
- <sup>2)</sup> 0 V to 10 V, 0/4 mA to 20 mA can be connected optionally.
- <sup>3)</sup> Digital inputs can be operated either with P or with N action.
- <sup>4)</sup> 0 V to 10 V, 0/4 mA to 20 mA can be connected optionally.

## Text display module

The following FL1F-RD1 module is available:

Symbol	Name	Supply voltage	Display
	FL1F-RD1	24 VAC/VDC 12 VDC	LCD (160 x 96) 6-row display

## Certification and approvals

IDEC SmartRelay is certified to cULus and cFMus.

- cULus Haz. and ordinary Loc.  
Underwriters Laboratories Inc. (UL) to
  - UL 508 (Industrial Control Equipment)
  - CSA C22.2 No. 142 (Process Control Equipment)
  - ANSI/ISA 12.12.01 (Hazardous Location)
  - CSA C22.2 No.213 (Hazardous Location)
 APPROVED for use in  
 Class I, Division 2, Group A, B, C, D Tx  
 Class I, Zone 2, Group IIC Tx
- FM Approval (US Approval and Canada Approval)  
Factory Mutual Research (FM) to
  - Approval Standard Class Number 3611, 3600, 3810
  - ANSI/IEC60529 2004
  - ANSI/NEMA 205 2003
  - CSA C22.2 No. 213
  - CSA C22.2 No. 1010-1
  - CSA C22.2 No.94
  - CSA C22.2 No.60529
 APPROVED for use in
  - Class I, Division 2, Group A, B, C, D Tx
  - Class I, Zone 2, Group IIC Tx

---

### Note

You will find current approvals on the rating plate of the relevant module.

---

IDEC SmartRelay is issued with the CE certification of conformity. It is compliant with following standards:

- EN 61131-2
- EN 61000-6-1, EN 61000-6-2, EN 61000-6-3, EN 61000-6-4
- EN 50581

Marine certificate of approval:

- ABS (American Bureau of Shipping)
- BV (Bureau Veritas)
- DNV-GL (Det Norske Veritas (Norwegen)-Germanischer Lloyd)
- LRS (Lloyds Register of Shipping)
- Class NK (Nippon Kaiji Kyokai)

IDEC SmartRelay modules are therefore suitable for use in industrial and residential areas. Use in Class I, Division 2, Group A, B, C and D locations or in non-hazardous locations is supported.

Marine certification is certified with the following conditions:

- All 12/24VDC modules are only to be used with 24VDC power supply.
- 24V power supply line are to be protected by surge protective device ((order No. 918 402/ 918 422 manufactured by DEHN+SÖHNE GmbH CO.) or equivalent).
- When using IDEC SmartRelay FL1F in bridge and deck zones with filter ((B84113-C-B-30 manufactured by EPCOS AG) or equivalent).

Please contact us if there are any questions such as about the environment in which IDEC SmartRelay is used.

## ID for Australia



Our products carrying the label shown at the side are compliant with AS/NZS CISPR11: 2011 (Class A) standard.

 <b>WARNING</b>
<b>Explosion hazard</b> Do not disconnect equipment while the circuit is live or unless the area is known to be free of ignitable concentrations. Substitution of any components can impair suitability for Class I, Division 2. Combinations of equipment are subject to investigation by the local authority having jurisdiction at the time of the installation.

## Recycling and Disposal

You can fully recycle IDEC SmartRelay devices due to their low-pollutant equipment. Contact a certified electronic waste disposal center for environmentally acceptable recycling and disposal of your old devices.



## General guidelines

Note the following guidelines for installing and wiring your IDEC SmartRelay:

- Always ensure that the wiring of your IDEC SmartRelay is compliant with current rules and standards. Also, conform with all national and regional regulations when you install and operate the devices. For information on standards and regulations that apply to your specific case, contact your local authorities.
- Always switch off power before you wire or install/remove a module.
- Always use cables with appropriate conductor cross-sections for the relevant current. You can wire IDEC SmartRelay with cable conductor cross-sections (Page 26) from 1.5 mm<sup>2</sup> to 2.5 mm<sup>2</sup>.
- Do not exceed the screw torque of the terminals. Range of torques: 0.5 Nm to 0.6 Nm.
- Keep the cabling as short as possible. If longer cables are necessary, use shielded versions. Always route your cables in pairs; that is, one neutral conductor plus one phase conductor or signal line.
- Always keep separate:
  - The AC wiring
  - High-voltage DC circuits with high-frequency switching cycles
  - Low-voltage signal wiring
- Install wires with appropriate strain relief.
- Provide a suitable lightning surge arrester for cables installed in hazardous areas.
- Do not connect an external power supply in parallel to the output load of a DC output. This could develop a reverse current at the output if you have not installed a diode or similar barrier device.
- Be sure to use only certified components to ensure reliable functioning of equipment.

---

### Note

Only skilled personnel who are familiar with and follow general engineering rules, relevant regulations and standards must install IDEC SmartRelay devices.

---



## What you must note when installing

IDEC SmartRelay is designed for fixed and enclosed installation in the housing or the control cabinet.

 <b>WARNING</b>
--

<p>IDEC SmartRelay is designed for installation in a cabinet. Do not install IDEC SmartRelay outside a cabinet. If IDEC SmartRelay is installed outside a cabinet, severe personal injury or death or damage to equipment may be caused due to unexpected operations.</p>
---

<p>You can operate IDEC SmartRelay from the front panel at any time.</p>
--

## Safety of electronic control equipment

### Introduction

The notes below apply regardless of the type or manufacturer of the electronic control.

### Approach for reliability

Maximum reliability of IDEC SmartRelay devices and components is achieved by implementing extensive and cost-effective measures during development and manufacture.

This includes the following:

- Use of high-quality components
- Design of all circuits for worst-case scenarios
- Systematic and computer-aided testing of all components
- Burn-in of all large-scale integrated circuits (for example, processors and memory)
- Prevention of static charge when handling MOS ICs (Metal Oxide Semiconductor Integrated Circuits)
- Visual checks at different stages of manufacture
- Continuous heat-run test at elevated ambient temperature over a period of several days
- Careful computer-controlled final testing
- Statistical evaluation of all returned systems and components to enable the immediate initiation of suitable corrective measures
- Monitoring of major control components, using online tests (cyclic interrupt for the CPU, etc.)

These measures are referred to as basic measures.

### **Carrying out tests**

You must ensure safety in your plant.

Before finally commissioning a system, carry out complete functional testing as well as all the necessary safety testing.

Also, test for any predictable faults that can occur. This means that you will avoid any danger to the plant or to people during operation.

### **Risks**

In all cases where the occurrence of failures can result in material damage or injury to persons, take special measures to enhance the safety of the installation - and the application. System-specific and special regulations exist for such applications. Follow these regulations exactly when installing the control system (for example, VDE 0116 for burner control systems).

For electronic control equipment with a safety function, the measures that you must take to prevent or rectify faults are based on the risks involved in the installation. Beyond a certain degree of hazard the basic measures mentioned above are not sufficient and you must take additional safety measures for the controller.

### **Important information**

Follow the instructions in the operating manual exactly. Incorrect handling can render measures intended to prevent dangerous faults ineffective, or generate additional sources of danger.

## **2.1 Modular IDEC SmartRelay setup**

### **2.1.1 Maximum IDEC SmartRelay network setup**

#### **Maximum IDEC SmartRelay network setup**

IDEC SmartRelay supports FL1F/Modbus Communication over a 10/100 Mbit/s TCP/IP Ethernet network.

An IDEC SmartRelay can support the following network connections:

- A maximum of 16 TCP/IP-based FL1F/Modbus Communication connections with the following devices:
  - Additional IDEC SmartRelay
  - Modbus over TCP/IP compatible device

There are two types of connections available for FL1F/Modbus Communication, static connection and dynamic connection. For the static connection, the server reserves the required resources for the connected client to ensure stable data transfer. For the dynamic connection, the server responds to a communication request only when free resources are available. You can configure the static/dynamic connections as required, for example, n static connections and 16-n dynamic connections. IDEC SmartRelay supports a maximum of eight static connections.

- A maximum of one TCP/IP Ethernet connection with the Text Display. A Text Display module can connect with different Base Modules through IP address selection, but can not communicate with more than one Base Module at the same time.

- A maximum of one TCP/IP Ethernet connection between a Base Module and a PC with WindLGC V8.0 or later installed.

**Note**

For detailed information about security functions on IDEC SmartRelay, see Chapter Security (Page 281).

**Note**

You can only construct an IDEC SmartRelay network using WindLGC V8.0 and later versions.

A **typical** IDEC SmartRelay network setup is shown below:

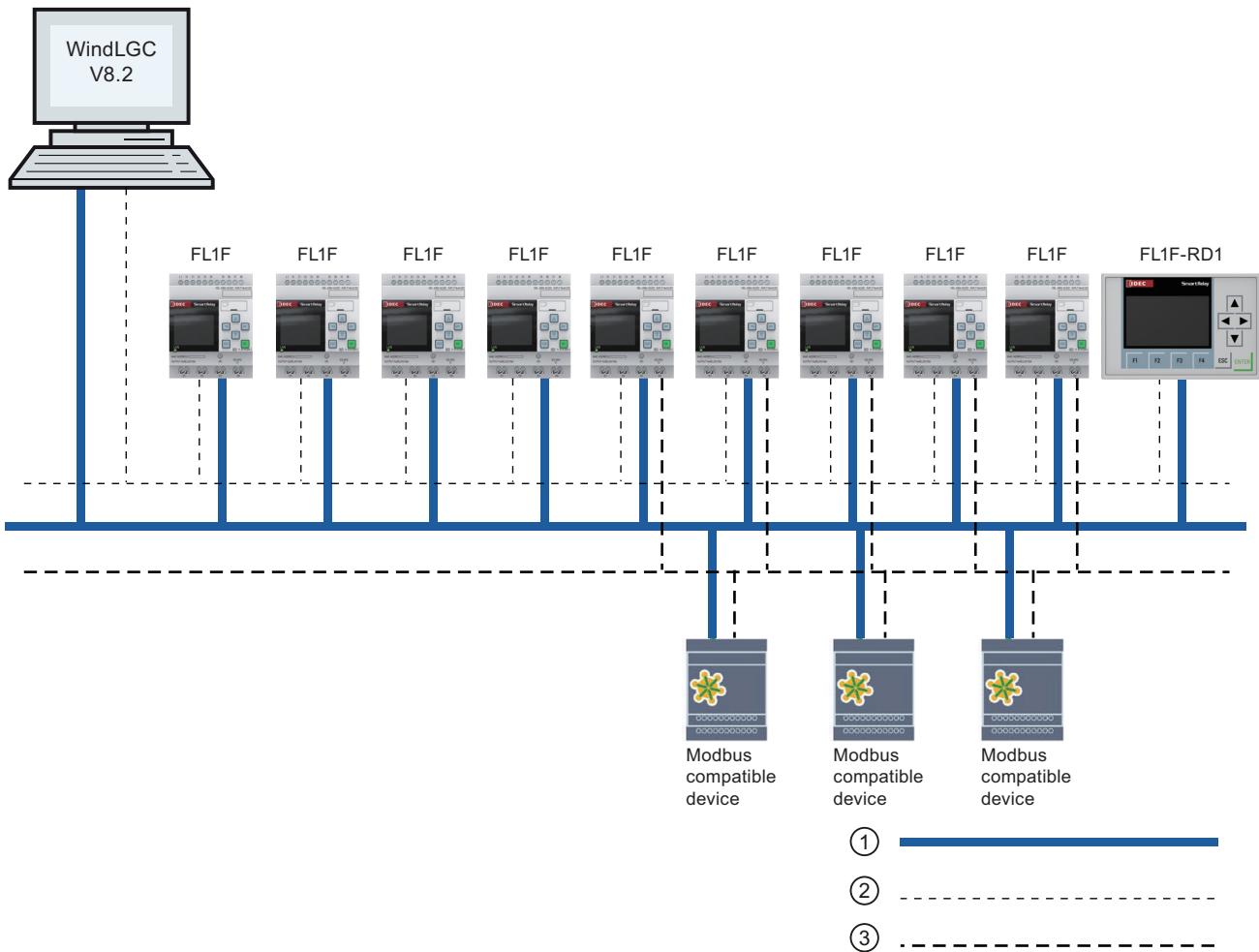

- ① Physical Ethernet connections
- ② Logical connection for communication between IDEC SmartRelay and PC (by TCP/IP-based Ethernet)
- ③ Logical connections for Modbus communication between Modbus compatible devices (with Modbus protocol over TCP/IP)

## 2.1.2 Maximum setup with expansion modules

IDEC SmartRelay supports a maximum of Getting started with IDEC SmartRelay (Page 1). You can achieve the maximum setup in different ways as shown below:

### Maximum setup of an IDEC SmartRelay *with* analog inputs onboard - four in use

Base Module, 4 digital modules and 6 analog modules (example)

I1, I2, I3 .. I6, I7, I8 AI3, AI4, AI1, AI2	I9..I12	I13..I16	I17..I20	I21..I24	AI5, AI6	AI7, AI8				
IDEC Smart-Relay Base Module	FL1F-M08	FL1F-M08	FL1F-M08	FL1F-M08	FL1F-J2B2	FL1F-J2B2	FL1F-K2BM2	FL1F-K2BM2	FL1F-K2BM2	FL1F-K2BM2
Q1..Q4	Q5..Q8	Q9..Q12	Q13..Q16	Q17..Q20			AQ1, AQ2	AQ3, AQ4	AQ5, AQ6	AQ7, AQ8

### Maximum setup of an IDEC SmartRelay *with* analog inputs onboard - two in use

Base Module, 4 digital modules and 7 analog modules (example)

I1, I2, I3 .. I6, I7, I8 AI1, AI2	I9..I12	I13..I16	I17..I20	I21..I24	AI3, AI4	AI5, AI6	AI7, AI8				
IDEC Smart-Relay Base Module	FL1F-M08	FL1F-M08	FL1F-M08	FL1F-M08	FL1F-J2B2	FL1F-J2B2	FL1F-J2B2	FL1F-K2BM2	FL1F-K2BM2	FL1F-K2BM2	FL1F-K2BM2
Q1..Q4	Q5..Q8	Q9..Q12	Q13..Q16	Q17..Q20				AQ1, AQ2	AQ3, AQ4	AQ5, AQ6	AQ7, AQ8

### Maximum setup of an IDEC SmartRelay *without* analog inputs onboard (FL1F-H12RCA/B12RCA and FL1F-H12RCC/B12RCC)

Base Module, 4 digital modules and 8 analog modules (example)

I1 . . . . . I8	I9..I12	I13..I16	I17..I20	I21..I24	AI1, AI2	AI3, AI4	AI5, AI6	AI7, AI8				
IDEC Smart-Relay Base Module	FL1F-M08	FL1F-M08	FL1F-M08	FL1F-M08	FL1F-J2B2	FL1F-J2B2	FL1F-J2B2	FL1F-J2B2	FL1F-K2BM2	FL1F-K2BM2	FL1F-K2BM2	FL1F-K2BM2
Q1..Q4	Q5..Q8	Q9..Q12	Q13..Q16	Q17..Q20					AQ1, AQ2	AQ3, AQ4	AQ5, AQ6	AQ7, AQ8

For FL1F-H12RCE/B12RCE and FL1F-H12SCD modules, you can configure whether the module uses zero, two or four of the four possible analog inputs. AI inputs are numbered consecutively depending on how many you configure the IDEC SmartRelay Base Module to use. If you configure two inputs, they are numbered AI1 and AI2, and correspond to the I7 and I8 input terminals. Subsequent AI expansions modules would begin numbering at AI3. If you configure four inputs, they are numbered AI1, AI2, AI3, and AI4, and correspond to I7, I8, I1, and I2 in that order. Subsequent AI expansions modules would begin numbering at AI5. See topics "Constants and connectors (Page 113)" and "Setting the number of AIs in IDEC SmartRelay (Page 270)".

### High-speed/optimal communication performance

For optimal and high-speed communication performance between the Base Module and the various modules, install the digital modules first, then the analog modules (as the examples above show). (The special function PI controller is an exception: the AI used for the value PV should be on the Base Module or an analog input module adjacent to the Base Module).

You install the Text Display module separately and connect it to the Base Module with the Ethernet interface.

### 2.1.3 Setup with different voltage classes

#### Rules

You can only connect digital modules to devices of the same voltage class.

You can connect analog modules to devices of any voltage class.

#### Overview: Connecting an expansion module to the IDEC SmartRelay Base Module

In the following tables, "X" means that the connection is possible; "-" means that the connection is not possible.

IDEC SmartRelay Base Module	Expansion modules				
	FL1F-M08B2R2	FL1F-M08B1S2	FL1F-M08D2R2	FL1F-M08C2R2	FL1F-J2B2/K2BM2
FL1F-H12RCE	x	x	x	-	x
FL1F-H12RCC	-	-	-	x	x
FL1F-H12SCD	x	x	x	-	x
FL1F-H12RCA	x	x	x	-	x
FL1F-B12RCE	x	x	x	-	x
FL1F-B12RCA	x	x	x	-	x
FL1F-B12RCC	-	-	-	x	x

**Overview: Connecting an additional expansion module to an expansion module**

Expansion module	Additional expansion modules				
	FL1F-M08B2R2	FL1F-M08B1S2	FL1F-M08D2R2	FL1F-M08C2R2	FL1F-J2B2/K2BM2
FL1F-M08B2R2	x	x	x	-	x
FL1F-M08B1S2	x	x	x	-	x
FL1F-M08D2R2	x	x	x	-	x
FL1F-M08C2R2	-	-	-	x	x
FL1F-J2B2/K2BM2	x	x	x	-	x

**2.1.4 Compatibility**

**The compatibility of modules**

All of IEEC SmartRelay FL1F modules are compatible with FL1F series only.

You cannot connect IEEC SmartRelay FL1F Base Modules to old expansion modules such as FL1E series.

You cannot connect IEEC SmartRelay FL1F expansion modules to old Base Modules such as FL1E series.

You cannot connect IEEC SmartRelay FL1F text display to old Base Modules such as FL1E series.

You can only use the Text Display module with equipment series FL1F.

The Text Display provides two Ethernet ports for network connection and six-line text display specifically for the IEEC SmartRelay FL1F device.

All FL1F expansion modules are completely compatible with the Base Modules of FL1F series and you can only use them with equipment of FL1F series.

IEEC SmartRelay supports micro SD cards.

**The compatibility of message texts**

You cannot edit message texts from the Base Module that contain any of the following parameters:

- Par
- Time
- Date
- EnTime
- EnDate
- Analog input
- Digital I/O status
- Special characters (for example: ±, € )

You can only edit such message texts from WindLGC.

**The compatibility of circuit diagram**

The circuit diagram in SD card can be used directly without format conversion.

The table below shows the detailed compatibility information for different device modules and circuit diagrams.

Device Module	Circuit Diagram hardware type	
	FL1F	FL1F FS5
FL1F module	Yes	No
FL1F FS5 module	Yes	Yes

## 2.2 Installing/removing IEEC SmartRelay

### Dimensions

The IEEC SmartRelay installation dimensions are compliant with DIN 43880.

IEEC SmartRelay can be snap-mounted to 35 mm DIN rails according to EN 60715 or mounted on the wall with two M4 screws.

IEEC SmartRelay width:

- Text Display has a width of 128.2 mm.
- Base Modules have a width of 71.5 mm.
- Expansion Modules have a width of 35.5 mm (FL1F-M08...)

**Note**

The figures below show you an example of the installation and removal of an FL1F-H12RCE and a digital module. The measures shown apply to all other Base Module versions and expansion modules.

<p> <b>WARNING</b></p> <p><b>Risk to life when you touch live parts</b></p> <p>Death or serious injury can result when you touch live parts.</p> <p>Always switch off power before you remove or insert an expansion module.</p>
---

## 2.2.1 DIN rail mounting

### Mounting

To **mount** a Base Module **and** a digital module onto a DIN rail, follow these steps:

1. Hook the Base Module onto the rail.
2. Push down the lower end to snap it on. The mounting interlock at the rear must engage.

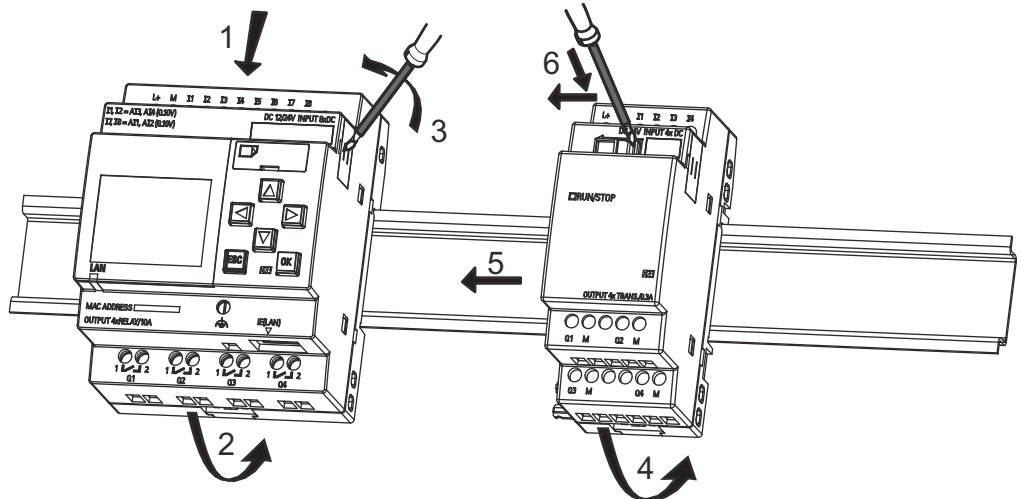

3. On the right side of the Base Module/Expansion Module, remove the connector cap.
4. Place the digital module onto the DIN rail on the right-hand side of the Base Module.
5. Slide the digital module towards the left until it contacts the Base Module.
6. Using a screwdriver, push the interlock to the left. In its end position the slide interlock engages in the Base Module.

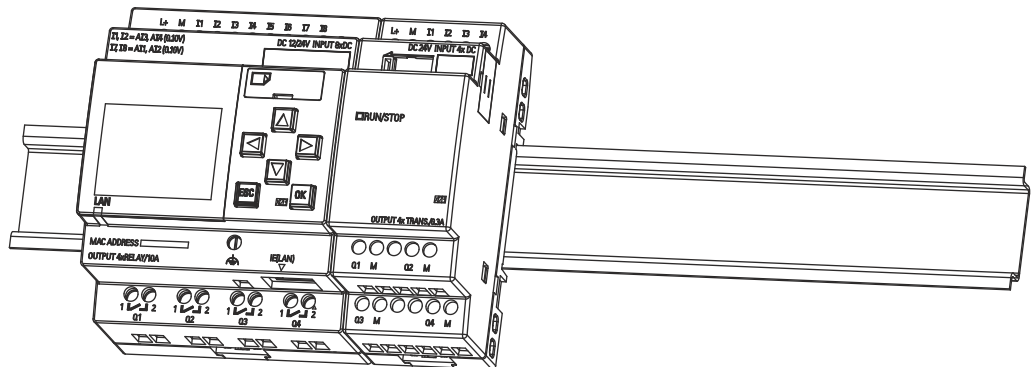

Repeat the digital module steps to mount further expansion modules.

#### Note

Be sure to cover the expansion interface on the last expansion module.



## Removal

To **remove** IDEC SmartRelay if you have installed **only one Base Module**, follow these steps:

1. Insert a screwdriver into the eyelet at the bottom of the slide interlock and move the latch downward.
2. Swing the Base Module off the DIN rail.

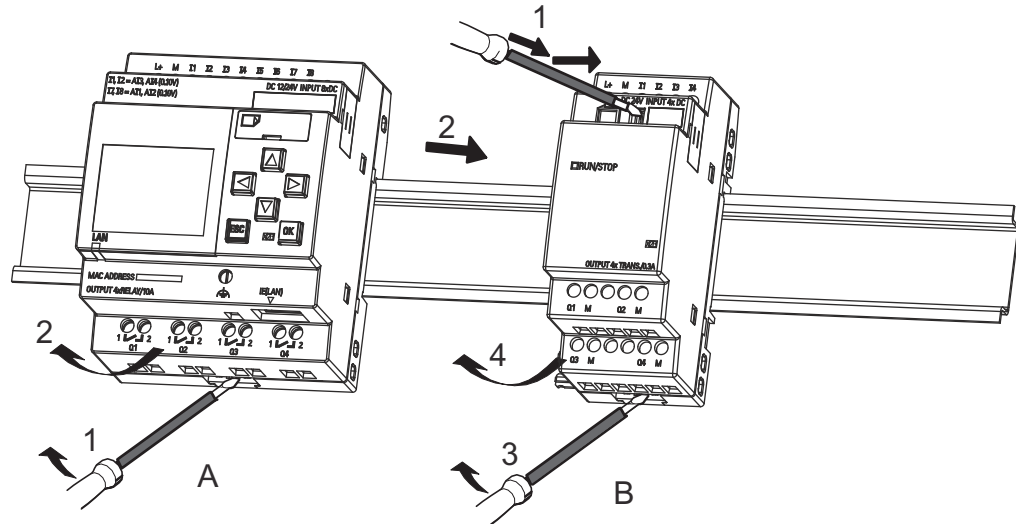

To **remove** IDEC SmartRelay if you have connected **at least one expansion module** to the Base Module, follow these steps:

1. Using a screwdriver, push the integrated slide interlock to the right.
  2. Slide the expansion module off towards the right.
  3. Insert a screwdriver into the eyelet at the bottom of the slide interlock and lever it downward.
  4. Swing the expansion module off the profile rail.
- Repeat steps 1 to 4 for all other expansion modules.
5. After removing all expansion modules, remove the base module.

---

### Note

When removing modules, be sure to disengage the slide interlock of the module that connects it to the next module. When removing multiple modules, it is easier to start with the last module on the right side.

---

## 2.2.2 Wall-mounting

Follow the instructions below to wall-mount IEEC SmartRelay by means of two mounting slides and two M4 screws (tightening torque 0.8 Nm to 1.2 Nm).

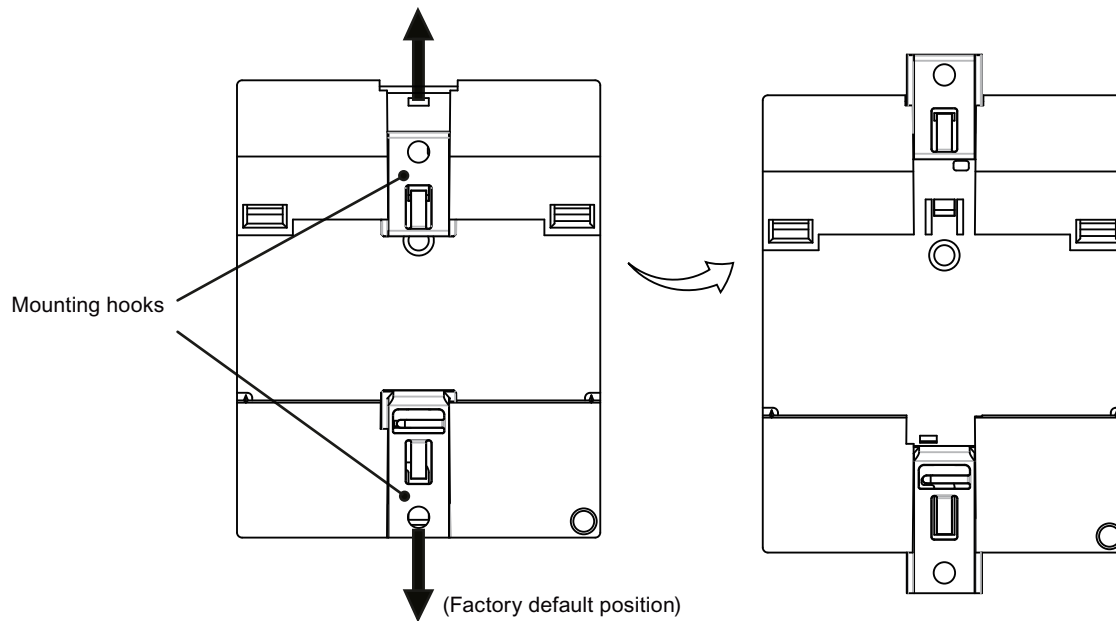

### Note

When you do not wall-mount IEEC SmartRelay, always keep the mounting hooks in the factory default positions, that is, within the data area given in the illustration above; otherwise, the mounting hooks may deform if they are exposed to hot and humid surroundings for a long term.

### Drilling template for wall-mounting

Before you can wall-mount IDEC SmartRelay, you need to drill holes using the template shown below:

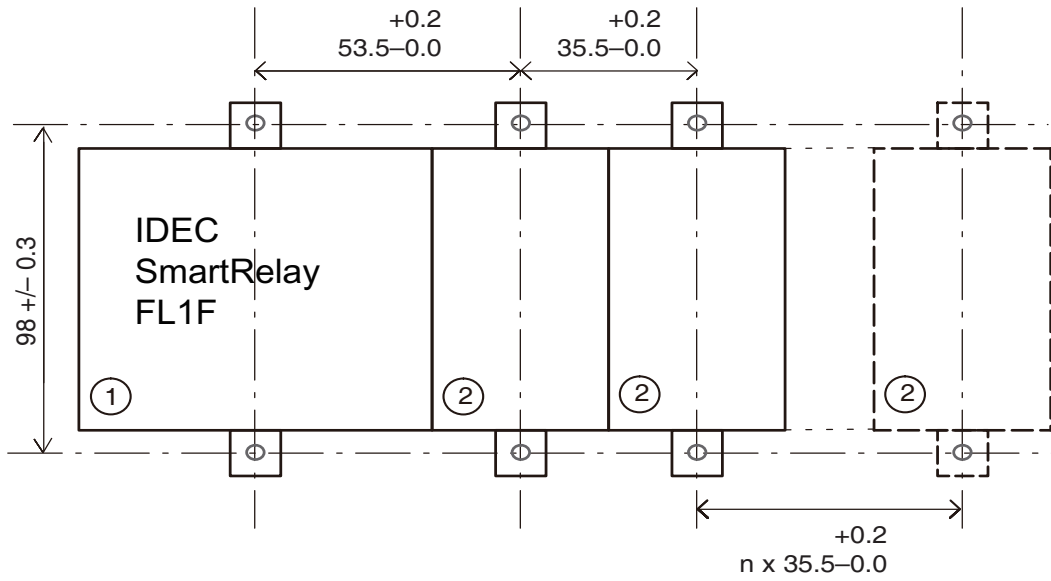

All dimensions in mm

Bore hole for M4 screw, tightening torque 0.8 Nm to 1.2 Nm

- ① Base Module
- ② Expansion Modules

### 2.2.3 Mounting the Text Display

**Note**

Make sure you mount the Text Display vertically on a flat surface of an IP 65 or Type 4X/12 enclosure.

To prepare the mounting surface for the optional Text Display and mount it, follow these steps:

1. Cut a 119 mm × 78.5 mm (tolerance: +0.5 mm) hole in the mounting surface.

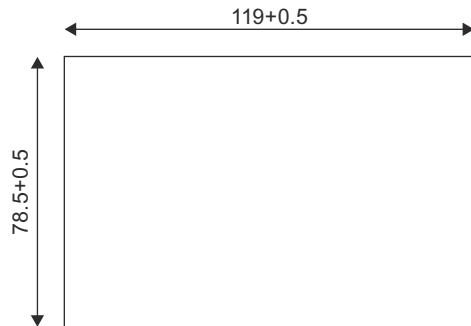

2. Place the included gasket on the frontplate of the Text Display.
3. Fit the Text Display into the cutout you made in the mounting surface.
4. Attach the mounting brackets (included) to the Text Display
5. Tighten the mounting screws on the mounting brackets to 0.2 Nm torque to secure the Text Display.

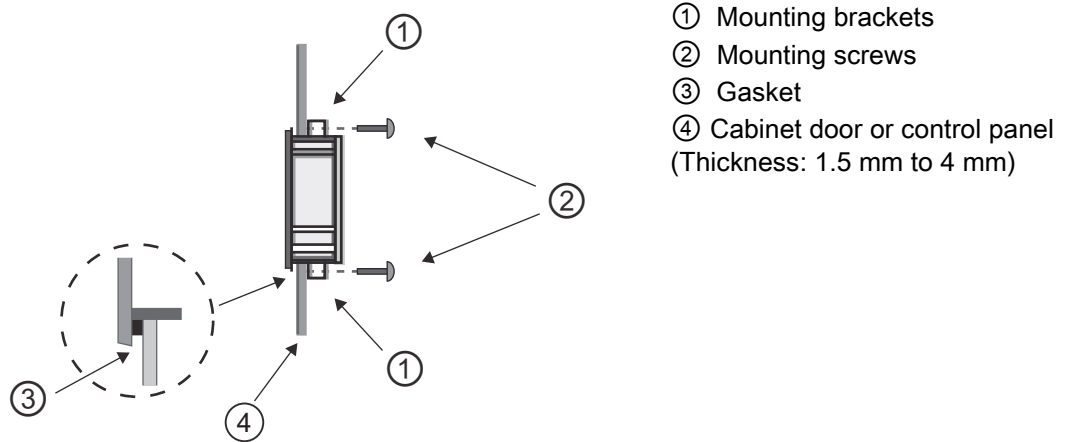

You can then connect the Text Display to the Base Module through the Ethernet interface.

### 2.2.4 Labeling IDEC SmartRelay

The rectangular areas on the IDEC SmartRelay modules are intended for labeling.

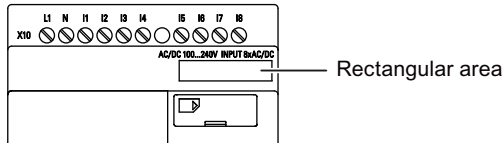

In the case of expansion modules, you can use the rectangular areas for labeling the inputs and outputs, for example. In this connection, you can enter a delta factor of +8 for the inputs or +4 for the outputs if the Base Module already has 8 inputs or 4 outputs.

### 2.3 Wiring IDEC SmartRelay

Wire IDEC SmartRelay using a screwdriver with a 3 mm blade.

You do not need to wire ferrules for the terminals. You can use conductors fulfilled the following requirements:

- Cross-sections of up to the following thicknesses:
  - 1 × 2.5 mm<sup>2</sup>
  - 2 × 1.5 mm<sup>2</sup> for each second terminal chamber
- Conductor material: Cu
- Insulation temperature rating: 75 °C
- Tightening torque: 0.5 Nm to 0.6 Nm or 4.5 in.lbf to 5.3 in.lbf

#### Recommended ferrules

Ferrules order No.  
 For 1-cable connection

Cross-section [mm <sup>2</sup> ]	AWG	Phoenix Contact Ferrule type No.	NIC HIFU Blade Terminals type No.	NIC HIFU Insulated Pin Terminals type No.
0.3	22	AI0,5-10WH	BT1.25-10-1	TGN-TC-1.25-11T
0.5	20	AI0,5-10WH		
0.75	18	AI0,75-8GY		
1.25	16	AI1,5-8BK	BT1.25-10-1 BT2-9-1	
2.0	14	AI2,5-8BU	BT2-9-1	-
Recommended crimping tool		CRIMPFOX ZA 3	NH1 NH61	NH11 NH32 NH65

For 2-cable connection

Cross-section [mm <sup>2</sup> ]	AWG	Phoenix Contact Ferrule type No.
0.3	22	AI-TWIN2X0,5-8WH
0.5	20	AI-TWIN2X0,5-8WH
0.75	18	AI-TWIN2X0,75-8GY
1.25	18	AI-TWIN2X1,5-8BK
Recommended crimping tool		CRIMPFOX ZA 3

**Note**

Always cover the terminals after you have completed the installation. To protect IDEC SmartRelay adequately from impermissible contact to live parts, comply with local standards.

### 2.3.1 Connecting the power supply

The 100-240 VAC/VDC versions of IDEC SmartRelay are suitable for operation with rated voltages of 100 VAC/VDC and 240 VAC/VDC. The IDEC SmartRelay 24 V and 12 V versions can be operated with a 24 VDC, 24 VAC or 12 VDC power supply. For information on permissible voltage tolerances, line frequencies and power consumption, refer to the installation instructions in the Product Information supplied with your device and to the technical data in Appendix A.

The Text Display must be supplied with a voltage of 12 VDC or 24 VAC/VDC.

 <b>CAUTION</b>
<p>Expansion modules FL1F-M08C2R2 must be operated with the same type of power supply (DC or AC) as for the connected 100-240 VAC/VDC version of the Base Module. The same supply output "+/- " on DC power supplies or "N/L" on AC power supplies must connect to the same phase on both the expansion module FL1F-M08C2R2 and the connected FL1F-H12RCC/B12RCC. Failure to follow the instructions could result in personal injury.</p>

**Note**

A power failure might cause an additional edge triggering signal at the special functions. The stored data will be from the last uninterrupted cycle.

When using different power supplies, supply power to the base module and expansion modules at the same time, or supply power to expansion modules before the base module. When supplying power to expansion modules after the base module, expansion modules may not be recognized by the base module.

When using different power supplies, the fast transient/burst immunity (IEC61000-4-4) will be 1kV (power supply).

### Connecting IDEC SmartRelay

Connect IDEC SmartRelay to the power supply as shown below, depending on whether your power supply is DC or AC:

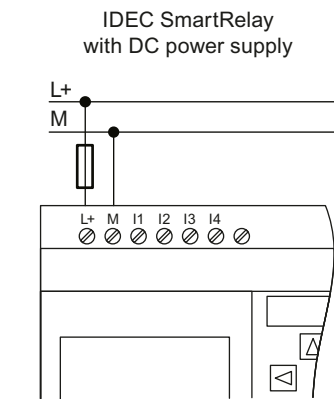

Protection with safety fuse  
if required (recommended) for:  
FL1F-H12RCE: 0.8 A  
FL1F-H12SCD: 2.0 A

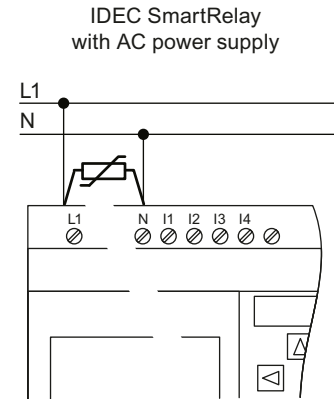

To suppress surge voltages, install  
varistors (MOV) with an operating  
voltage at least 20% above the rated  
voltage.

---

#### Note

IDEC SmartRelay is a double-insulated switchgear. You must connect its FE terminal to earth ground.

---

### Circuit protection with AC voltage

To suppress voltage peaks on the power supply lines, you can install a metal oxide varistor (MOV). Make sure the operating voltage of the varistor (MOV) used lies at least 20% above the rated voltage.

### Circuit protection with DC voltage

To suppress voltage peaks on the power supply lines, install a protection device.

### 2.3.2 Connecting the Text Display power supply

You must connect the FL1F-RD1 to an external power supply that supplies a voltage of 12 VDC or 24 VAC/VDC. Text Display includes a power connector. Connect the power supply to the power connector then plug the power connector to the power supply interface on Text Display.

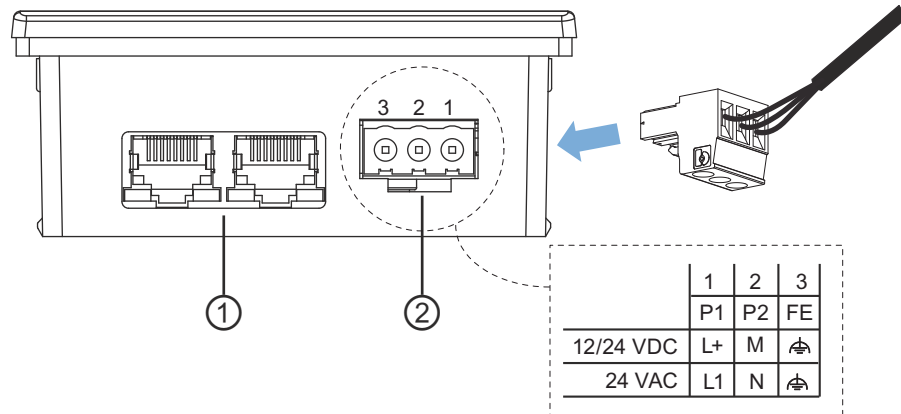

- ① Ethernet interfaces
- ② Power supply
  - The power connection is non-polar. If you connect a DC power supply to the Text Display, you can connect the positive supply wire or negative supply wire to either pin 1 or pin 2.
  - Pin 3 must be connected to the ground.

**Note**

IDEC recommends that you protect the Text Display with a 0.5 A safety fuse on the power supply.

### 2.3.3 Connecting IDEC SmartRelay inputs

#### Requirements

At the inputs you connect sensor elements such as: momentary pushbuttons, switches, light barriers, daylight control switches etc.



Sensor characteristics for IDEC SmartRelay

	FL1F-H12RCE FL1F-B12RCE		FL1F-H12SCD		FL1F-H12RCA FL1F-B12RCA		FL1F-H12RCC FL1F-B12RCC	
	I3 ~ I6	I1,I2,I7,I8	I3 ~ I6	I1,I2,I7,I8	AC	DC	AC	DC
Input voltage (Signal 0)	< 5 V DC	< 5 V DC	< 5 V DC	< 5 V DC	< 5 V AC	< 5 V DC	< 40 V AC	< 30 V DC
Input current (Signal 0)	< 0.88mA	< 0.07mA	< 0.9mA	< 0.07mA	< 1.2mA	< 1.2mA	< 0.05mA	< 0.06mA
Input voltage (Signal 1)	> 8.5 V DC	> 8.5 V DC	> 12 V DC	> 12 V DC	> 12 V AC	> 12 V DC	> 79 V AC	> 79 V DC
Input current (Signal 1)	> 1.5mA	> 0.12mA	> 2.1mA	> 0.18m	> 2.6mA	> 2.6mA	> 0.08 mA	> 0.13mA

	FL1F-M08B2R2	FL1F-M08B1S2	FL1F-M08D2R2		FL1F-M08C2R2	
			AC	DC	AC	DC
Input voltage (Signal 0)	< 5 V DC	< 5 V DC	< 5 V AC	< 5 V DC	< 40 V AC	< 30 V DC
Input current (Signal 0)	< 0.88mA	<0.88mA	< 1.1mA	< 1.1mA	< 0.05mA	< 0.06mA
Input voltage (Signal 1)	> 8.5 V DC	> 12 V DC	> 12 V AC	> 12 V DC	> 79 V AC	> 79 V DC
Input current (Signal 1)	> 1.5mA	> 2.1mA	> 2.63mA	> 2.63mA	> 0.08 mA	> 0.13mA

**Note**

FL1F-H12RCC/B12RCC contains two groups of four inputs, for a total of eight. **Within** each group, you must operate all inputs on the **same** phase. **Different** phases are only possible **between** the groups.

Example: I1 to I4 on phase **L1**, I5 to I8 on phase **L2**.

You must **not** connect the inputs of the FL1F-M08C2R2 to different phases.

Sensor connections

Connecting glow lamps and two-wire proximity switches (Bero) to FL1F-H12RCC/B12RCC or FL1F-M08C2R2 (AC)

The figure below shows how you connect a switch with a glow lamp to IDEC SmartRelay. The current that flows through the glow lamp allows IDEC SmartRelay to detect a "1" signal even though the switch contact is not closed. If, however you use a switch that has the glow lamp fitted with a power supply, this response does not occur.

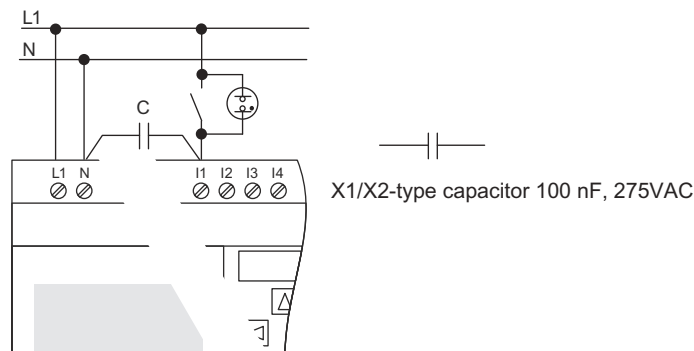

Take into account the quiescent current of any two-wire proximity switches that you use. The level of the quiescent current of some two-wire proximity switches is high enough to trigger a logical "1" signal at the IEEC SmartRelay input. You should therefore compare the quiescent current of the proximity switches with the Technical data (Page 293).

#### Remedy

To suppress this response, use an X1/X2-type capacitor rated at 100 nF and 275 VAC. In a destructive situation, this type of capacitor safely disconnects. You must choose the voltage level for which the capacitor is rated such that it is not destroyed in the case of overvoltage!

At 230 VAC, the voltage between N and an input I(n) must not be greater than 40 V to guarantee a "0" signal. You can connect approximately ten glow lamps to the capacitor.

### Restrictions

#### Signal status transitions 0 → 1/1 → 0

After a 0 to 1 or 1 to 0 transition, the signal must remain constant at the input at least for the duration of one program cycle, so that IEEC SmartRelay can detect the new signal status.

The size of the circuit program determines the program execution time. The appendix "Determining the cycle time (Page 313)" contains a benchmark test routine that you can use to determine the current scan cycle time.

### Special features of FL1F-H12RCE/B12RCE and FL1F-H12SCD

#### Fast digital inputs: I3, I4, I5 and I6

These modules include fast digital inputs (up/down counters, frequency triggers). The restrictions mentioned earlier do not apply to these fast digital inputs.

---

#### Note

Expansion modules do not have fast digital inputs.

---

#### Analog inputs: I1 and I2, I7 and I8

You can use the inputs I1, I2, I7 and I8 of IEEC SmartRelay versions FL1F-H12RCE/B12RCE and FL1F-H12SCD as either digital inputs or analog inputs. The IEEC SmartRelay circuit program defines the input mode (digital or analog).

The inputs I1, I2, I7 and I8 provide digital inputs, and the inputs AI3, AI4, AI1 and AI2 provide analog inputs, as described in the topic "Constants and connectors (Page 113)". AI3 corresponds to the input terminal I1; AI4 corresponds to I2; AI1 corresponds to I7; AI2 corresponds to I8. The use of AI3 and AI4 is optional. You configure your IEEC SmartRelay to use either two or four analog inputs as the topic "Setting the number of AIs in IEEC SmartRelay (Page 270)" describes.

When using inputs I1, I2, I7 and I8 as analog inputs, only the range from 0 to 10 VDC is available.

**Connecting a potentiometer to inputs I1, I2, I7 and I8**

To allow you to achieve 10 V as the maximum value when you completely turn the potentiometer once, you must connect a series resistor on the potentiometer's input side regardless of the input voltage (see figure below).

We suggest the following sizes of potentiometers and associated series resistors:

Voltage	Potentiometer	Series Resistor
12 V	5 kΩ	-
24 V	5 kΩ	6.6 kΩ

When using a potentiometer and 10 V input voltage as the maximum value, you must ensure that with a connected input voltage of 24 V, 14 V must release via the series resistor to ensure a maximum supply of 10 V when you turn the potentiometer one full rotation. With a voltage of 12 V, you can neglected this.

**Note**

The FL1F-J2B2 expansion module provides additional analog inputs.

Always use shielded cables for analog signals, and keep these as short as possible.

**Sensor connections**

Connect sensors to IDEC SmartRelay as shown below.

**FL1F-B12RCE/H12RCE and FL1F-B12RCA/H12RCA/H12SCD**

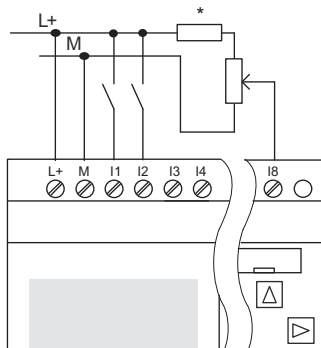

The inputs of these devices are not isolated and therefore require a common reference potential (chassis ground).

With FL1F-H12RCE/B12RCE and FL1F-H12SCD modules, you can tap analog signals between the supply voltage and chassis ground (\* = series resistor (6.6 kΩ) at 24 VDC).

Connection example

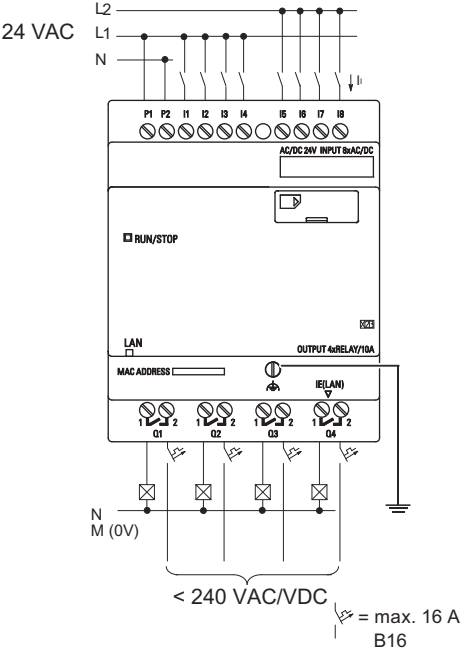

FL1F-B12RCC/H12RCC

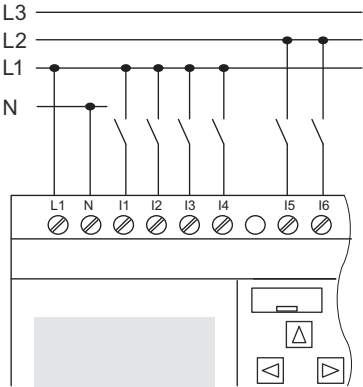

The inputs of these devices are in two groups, each consisting of four inputs. Different phases are only possible between groups, but not within the groups.

Connection example

Two-phase connection of the Base Module

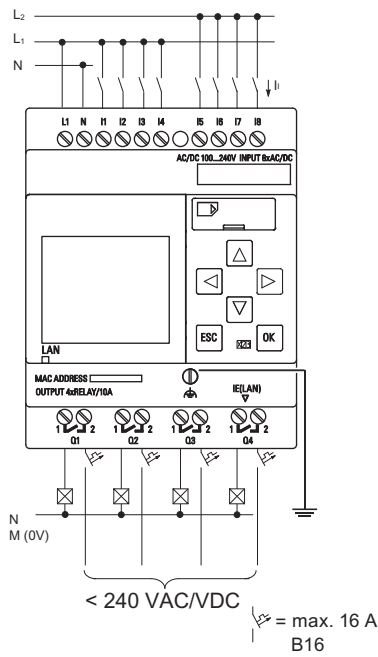

Three-phase connection of the Base Module with an expansion module

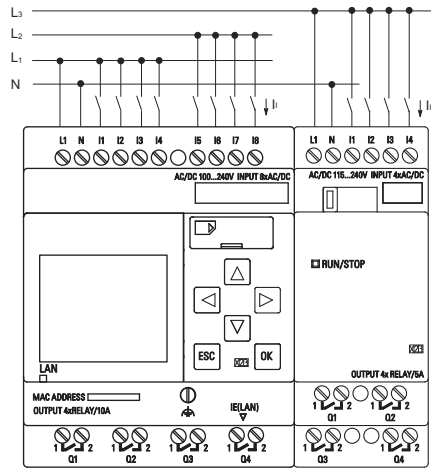

**⚠ WARNING**

Current safety regulations (VDE 0110, ... and IEC 61131-2, ... as well as UL 508) do not permit the connection of different phases to an AC input group (I1 to I4 or I5 to I8) or to the inputs of a digital module.

## FL1F-J2B2

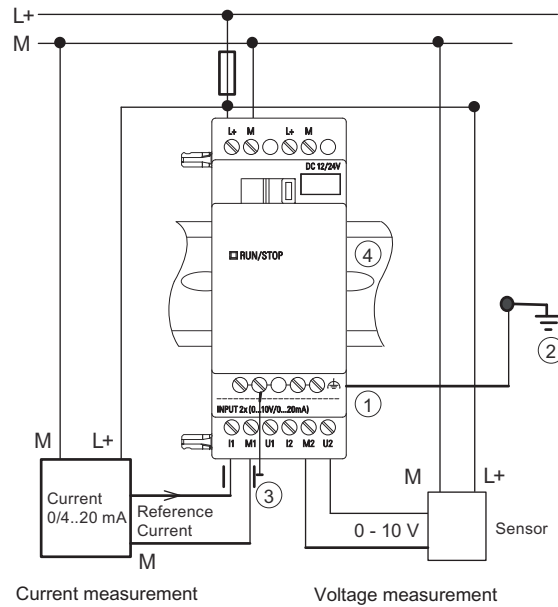

- |  |                     |
|--|---------------------|
| ① FE terminal for connecting earth and shielding the cable | ③ Shielded cable    |
| ② Earth  | ④ Standard DIN rail |

The illustration above shows an example of four-wire current measurement and two-wire voltage measurement.

### Connecting a two-wire sensor to the FL1F-J2B2

Wire up the two-wire sensor's connecting wires as follows:

1. Connect the sensor's output to connection U (0 V to 10 V voltage measurement) or to connection I (0/4 mA to 20 mA current measurement) of the FL1F-J2B2 module.
2. Connect the plus connector on the sensor to the 24 V supply voltage (L+).
3. Connect the ground connection of the current output M (on the right side of the sensor, as shown in the figure above) to the corresponding M input (M1 or M2) on the FL1F-J2B2 module.

### Note

Fluctuating analog values can occur if you do not mount/correctly mount the screening on the connecting wire from the analog valuator device to the analog FL1F-J2B2 expansion module (encoder wire).

To avoid fluctuating analog values when using these expansion modules, take the following measures:

- Use only shielded cable.
- Shorten the cable as much as possible. The cable must not be more than 10 meters long.
- Clamp the cable on one side only and clamp it only to the FE terminal on the FL1F-J2B2/ K2BM2 expansion module.
- Connect the earth to the FE terminal on the expansion module.

Input Internal Circuit

FL1F-H12RCC / FL1F-B12RCC

Digital AC/DC Input

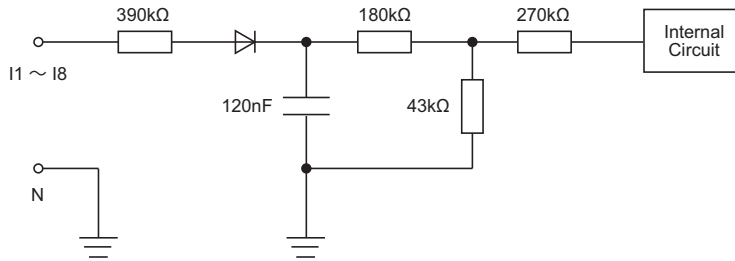

FL1F-M08C2R2

Digital AC/DC Input

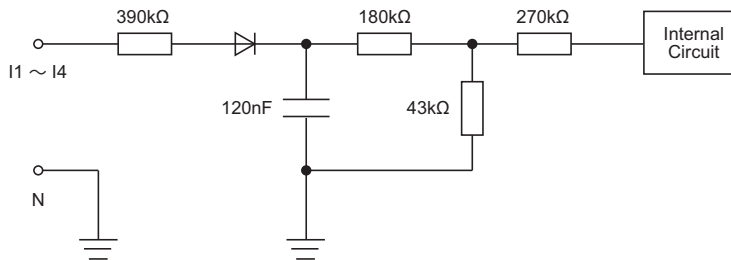

When using the AC two-wire sensor

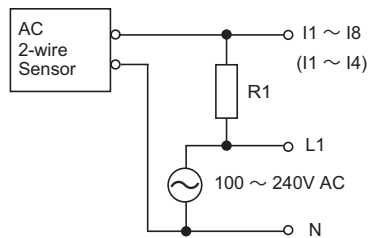

Note : Bleeder resistance (R1) calculation

R1 must satisfy the following three conditions.

Condition 1:  $R1 (\Omega) \leq \frac{\text{Maximum input OFF voltage } (= 40V \text{ AC})}{\text{Maximum sensor leakage current (A)}}$

Condition 2:  $R1 (\Omega) \leq \frac{\text{Sensor power voltage (V)}}{\text{Minimum sensor load current (A)}}$

The voltage drop across the load (R1) must be less than 40V while the sensor is turned off.

Condition 3:  $P_{R1} (W) \geq \frac{\{\text{Sensor power voltage (V)}\}^2}{R1 \text{ resistance } (\Omega)} \times 3$  (3: recommended allowance)

### FL1F-H12RCA / FL1F-B12RCA

Digital AC/DC Input

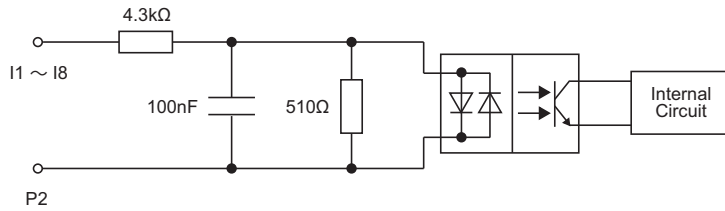

### FL1F-M08D2R2

Digital AC/DC Input

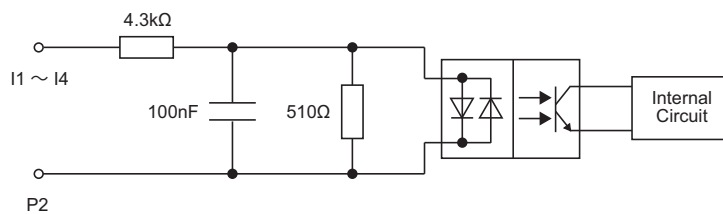

When using the AC two-wire sensor

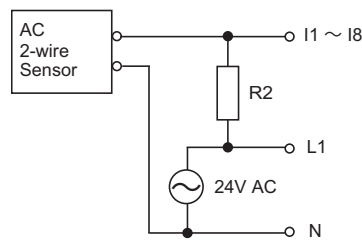

Note : Bleeder resistance (R2) calculation

R3 must satisfy the following three conditions.

$$\text{Condition 1: } R2 (\Omega) \leq \frac{\text{Maximum input OFF voltage (= 5V AC)}}{\text{Maximum sensor leakage current (A)}}$$

$$\text{Condition 2: } R2 (\Omega) \leq \frac{\text{Sensor power voltage (V)}}{\text{Minimum sensor load current (A)}}$$

The voltage drop across the load (R2) must be less than 5V while the sensor is turned off.

$$\text{Condition 3: } PR2 (W) \geq \frac{\{\text{Sensor power voltage (V)}\}^2}{R2 \text{ resistance } (\Omega)} \times 3 \text{ (3: recommended allowance)}$$

### FL1F-H12RCE / FL1F-B12RCE / FL1F-H12SCD

Digital DC Input

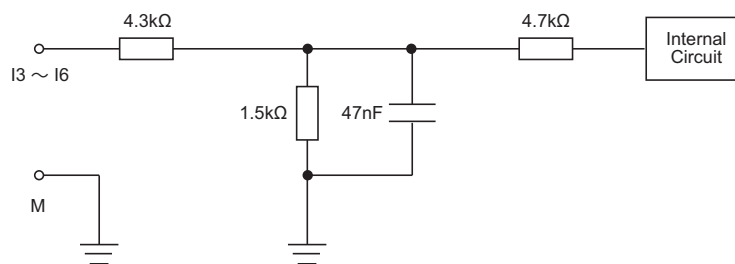



**FL1F-M08B2R2/FL1F-M08B1S2**

Digital DC Input

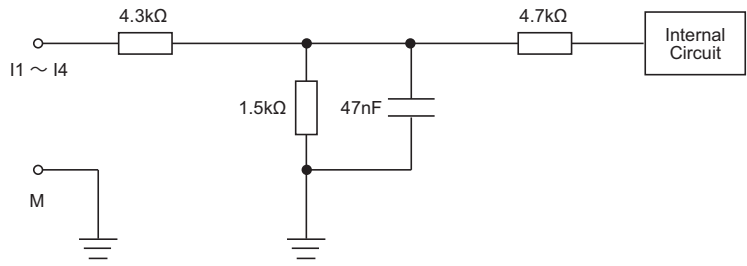

**FL1F-H12RCE / FL1F-B12RCE / FL1F-H12SCD**

Analog Input (0-10V)

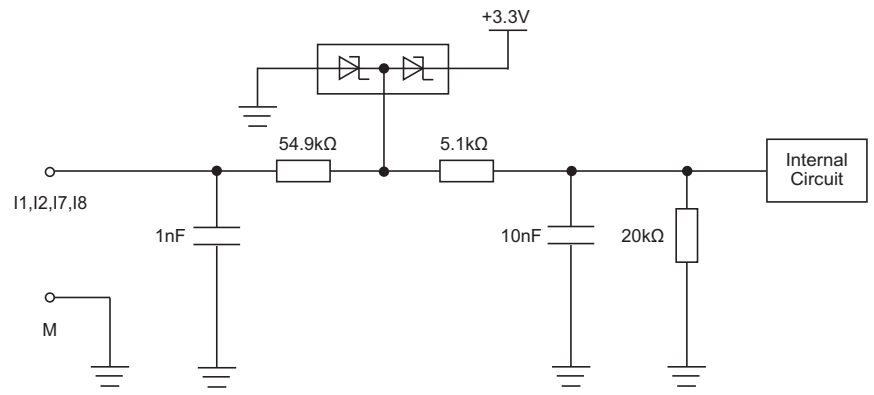

**FL1F-J2B2**

Analog Input (0-10V)

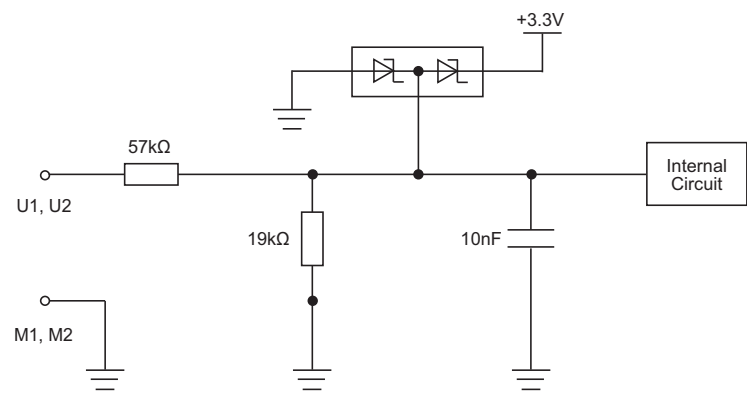

## FL1F-J2B2

Analog Input (0-20mA)

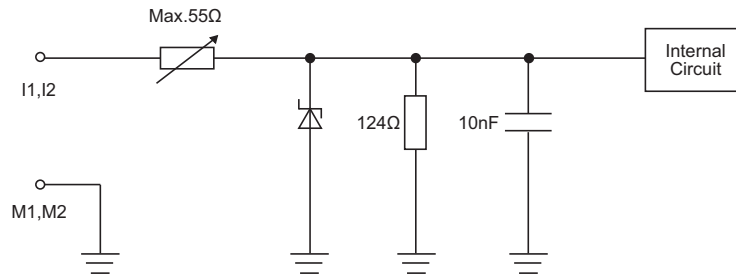

### 2.3.4 Connecting outputs

#### FL1F-H12RCA/B12RCA/H12RCC/B12RCC/H12RCE/B12RCE

The FL1F-H12RCA/B12RCA/H12RCC/B12RCC/H12RCE/B12RCE version includes relay outputs. The potential of the relay contacts is isolated from the power supply and the inputs.

#### Requirements for relay outputs

You can connect various loads to the outputs; for example lamps, fluorescent lamps, motors, contactor relays, and so on. For information on the properties required for the loads connected to FL1F-H12RCA/B12RCA/H12RCC/B12RCC/H12RCE/B12RCE, refer to the General technical data (Page 293).

**NOTICE**

**IDEC SmartRelay Relay contacts may be damaged by a high inrush current.**

When low energy lamps or LED Lamps are controlled by IDEC SmartRelay relay outputs, the energy lamps and/or LED lamps may have a very high inrush current. If the inrush current is not limited, the IDEC SmartRelay relay contacts may be damaged after some switch cycles.

Use an inrush current limiter to protect the relay contacts.

### Connecting

Connect the load to FL1F-H12RCA/B12RCA/H12RCC/B12RCC/H12RCE/B12RCE as shown below:

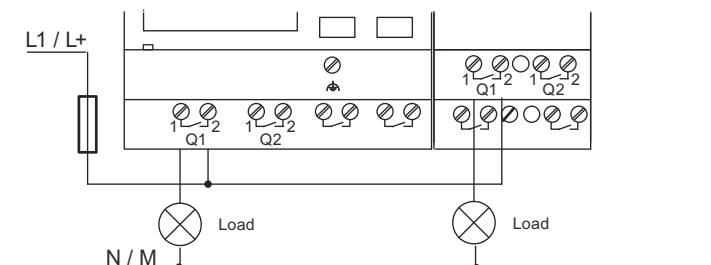

Protection with automatic circuit-breaker, max. 16 A, characteristics B16

### IDEC SmartRelay with transistor outputs

You can identify IDEC SmartRelay versions with transistor outputs by the fact that the letter **R** is missing from their type name. The outputs are short circuit-proof and overload-proof. An auxiliary load voltage supply is not necessary, because IDEC SmartRelay supplies the load voltage.

### Requirements for transistor outputs

The load connected to IDEC SmartRelay must have the following characteristics:

- The maximum switched current is 0.3 A per output.

### Connecting

Connect the load to an IDEC SmartRelay with transistor outputs as shown below:

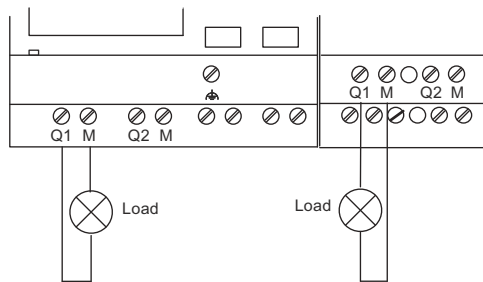

Load: 24 VDC, 0.3 A max.

### FL1F-K2BM2

The illustration below shows an example of how to connect the voltage or current load.

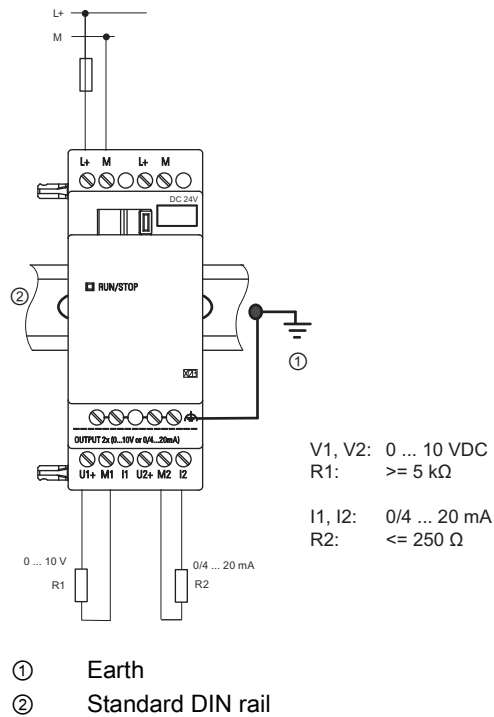

### Output Internal Circuit

FL1F-H12RCA / FL1F-B12RCA / FL1F-H12RCC / FL1F-B12RCC / FL1F-H12RCE / FL1F-B12RCE /  
FL1F-M08B2R2 / FL1F-M08C2R2 / FL1F-M08D2R2

Relay Output

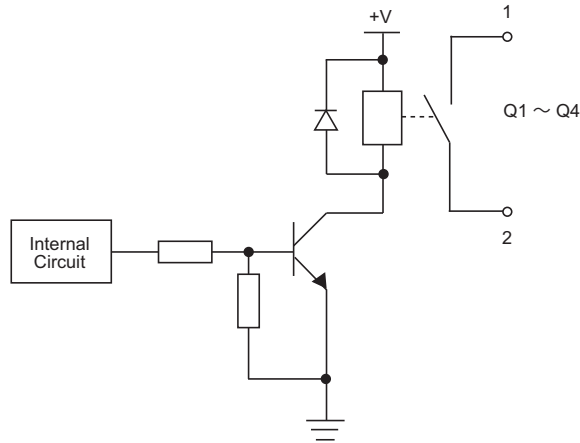

FL1F-H12SCD / FL1F-M08B1S2

Transistor Output (Source)

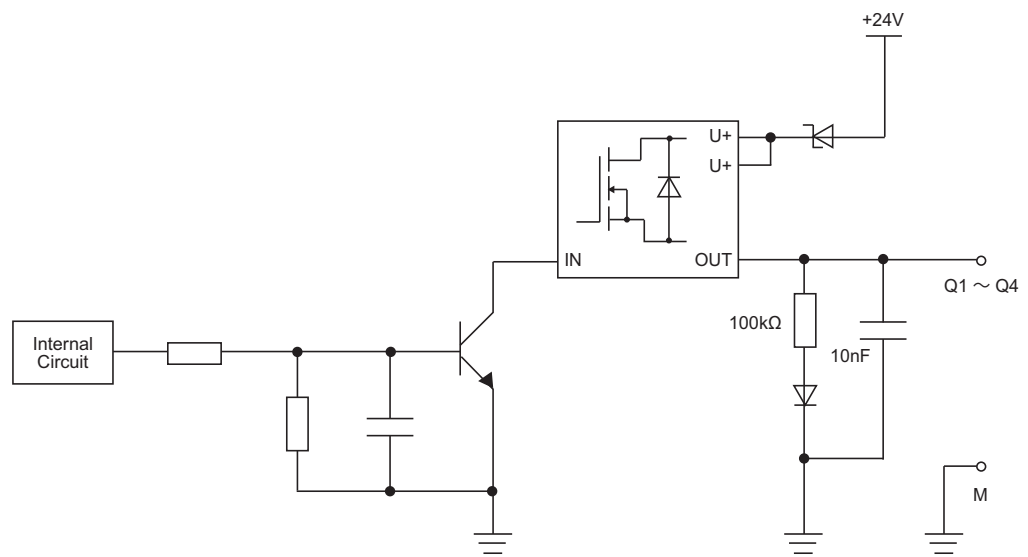

### FL1F-K2BM2

Analog Output (0-10V)

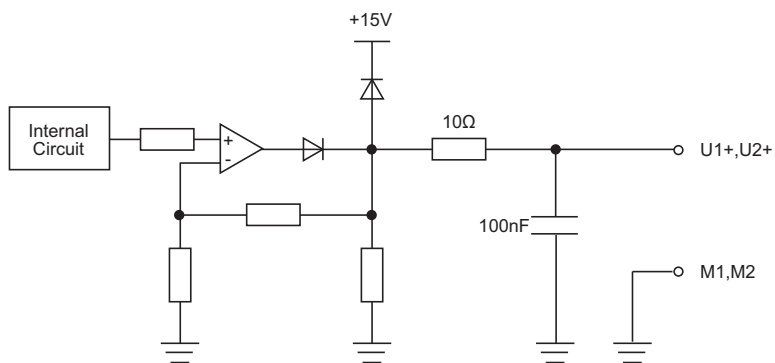

### FL1F-K2BM2

Analog Output (0/4 ... 20mA)

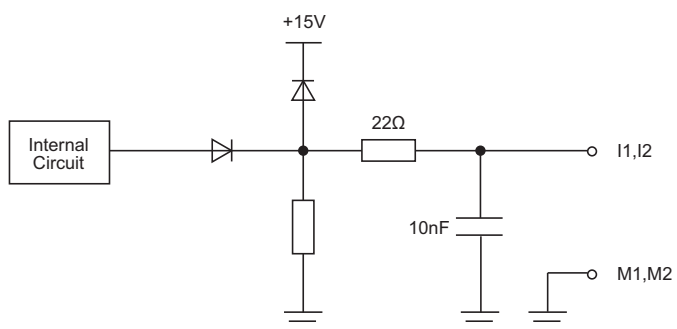

### 2.3.5 Connecting the Ethernet interface

Base modules and text display are equipped with a 10/100 Mbit/s Ethernet RJ45 interface.

#### Requirements for the network cable

Use a shielded Ethernet cable to connect to the Ethernet interface. To minimize electromagnetic interference, make sure you use a standard Category 5 shielded twisted-pair Ethernet cable with a shielded RJ45 connector on each end.

#### Connecting

You connect the FE terminal to earth ground, and connect a network cable to the Ethernet interface.

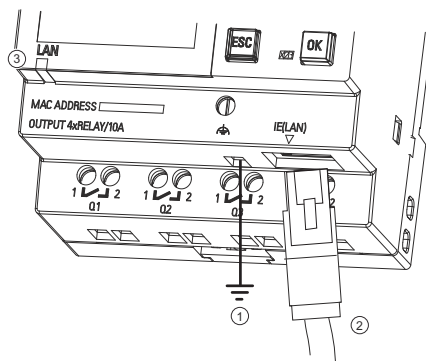

- ① Earth ground
- ② Ethernet cable, for connecting to the Ethernet interface
- ③ Ethernet status LED

#### Ethernet status LED

LED type	Color	Description
Status LED	Flashing orange	IDEC SmartRelay is receiving/sending data across Ethernet.
	Steady green	IDEC SmartRelay is already connected to Ethernet.

## 2.4 Putting into operation

### 2.4.1 Powering on IDEC SmartRelay

IDEC SmartRelay does not have a power switch. The reaction of IDEC SmartRelay during startup depends on the following:

- Whether a circuit program is stored in IDEC SmartRelay
- Whether a micro SD card is inserted
- Whether this is an IDEC SmartRelay version without display unit (FL1F-B12RCE/B12RCA/B12RCC)
- Whether IDEC SmartRelay is in RUN mode or STOP mode at the time of power failure

To ensure that the expansion module on IDEC SmartRelay changes to RUN mode, check the following:

- Has the sliding contact between IDEC SmartRelay and the expansion module snapped into place properly?
- Is the power supply connected to the expansion module?
- In addition, always ensure that you switch on the power supply to the expansion module first before activating the power supply to the Base Module (or activate both power supplies at the same time); if you do not do this, the system does not detect the expansion module when you start up the Base Module.

The following illustration shows all possible reactions of IDEC SmartRelay:

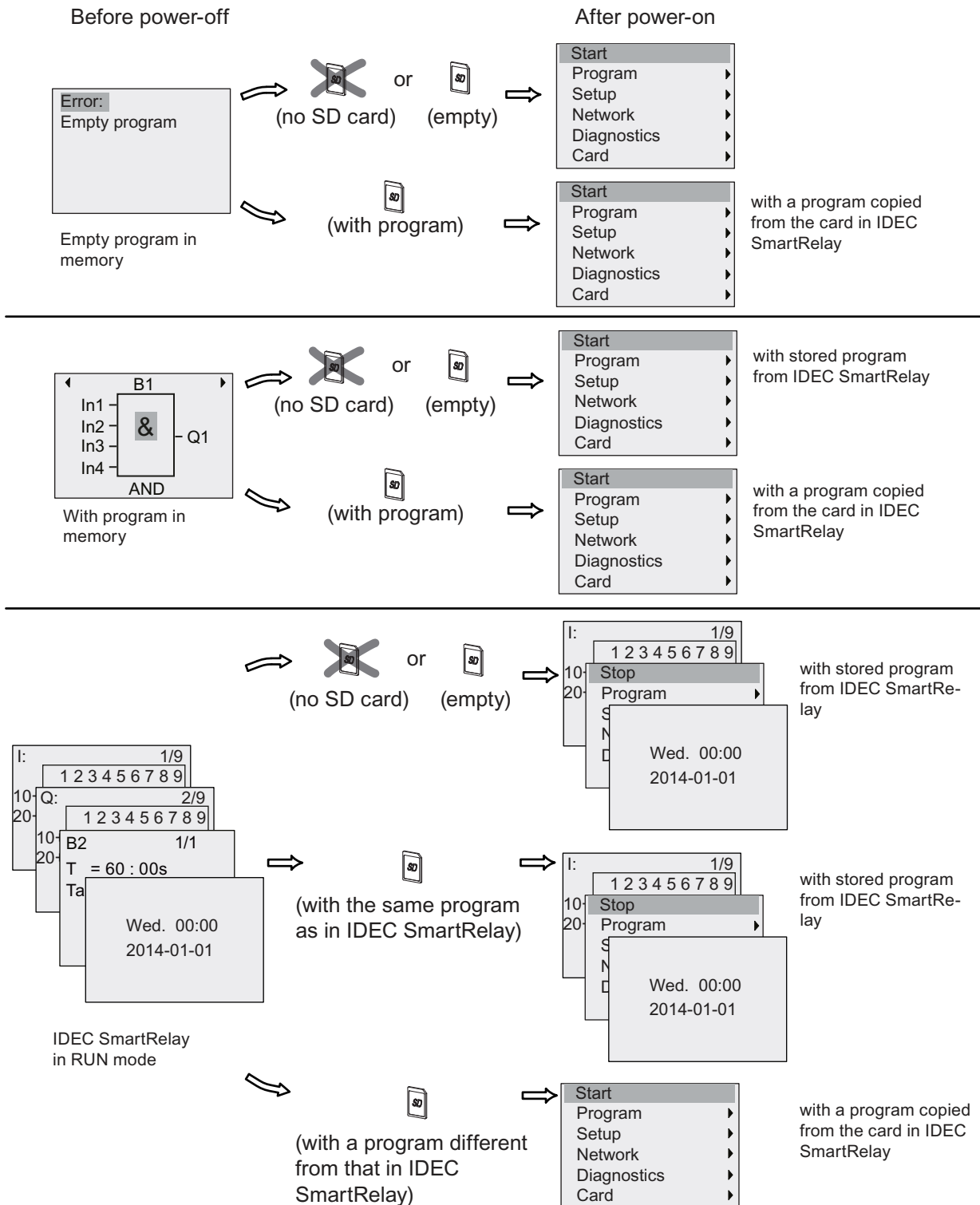

You can also memorize four simple rules for starting IDEC SmartRelay :



1. If neither IDEC SmartRelay nor the inserted card contains a circuit program, the Base Module displays the following:

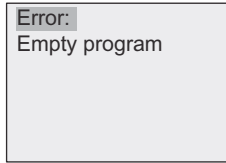

2. IDEC SmartRelay automatically copies the circuit program on the card to memory and overwrites the existing circuit program.
3. If there is a circuit program in IDEC SmartRelay or on the card, IDEC SmartRelay adopts the operational state it had prior to power-off. Versions without a display unit (FL1F-B12RCE/B12RCA/B12RCC) automatically change from STOP to RUN (LED changes from red to green).
4. If you have enabled retentivity for at least one function, or a function is permanently retentive, IDEC SmartRelay retains the current values at power-off.

---

**Note**

When a power failure occurs while you are entering a circuit program, the program in IDEC SmartRelay is missing after power is returned.

Before you modify the circuit program, save a backup copy of your original to a card or to a computer using WindLGC.

---

## 2.4.2 Operating states

### Base Module operating states

Base Modules (Version with and without LCD Display) have two operating states: STOP and RUN.

STOP	RUN
<ul style="list-style-type: none"> <li>• The display shows that the program is empty when you start the program (except for FL1F-B12RCE/B12RCA/B12RCC devices)</li> <li>• Switching IDEC SmartRelay to programming mode (except for FL1F-B12RCE/B12RCA/B12RCC devices)</li> <li>• LED is red (only for FL1F-B12RCE/B12RCA/B12RCC devices)</li> </ul>	<ul style="list-style-type: none"> <li>• Display: Screen mask for monitoring I/O and messages (after START in the main menu) or for the parameter assignment menu (except for FL1F-B12RCE/B12RCA/B12RCC devices)</li> <li>• Switching IDEC SmartRelay to parameter assignment mode (except for FL1F-B12RCE/B12RCA/B12RCC devices)</li> <li>• LED is green (only for FL1F-B12RCE/B12RCA/B12RCC devices)</li> </ul>
Action of IDEC SmartRelay: <ul style="list-style-type: none"> <li>• The input data is not read.</li> <li>• The circuit program is not executed.</li> <li>• The relay contacts are permanently open or the transistor outputs are switched off.</li> </ul>	Action of IDEC SmartRelay: <ul style="list-style-type: none"> <li>• IDEC SmartRelay reads the status of the inputs.</li> <li>• IDEC SmartRelay uses the circuit program to calculate the status of the outputs.</li> <li>• IDEC SmartRelay switches the relay/transistor outputs on or off.</li> </ul>

#### Note

After switching the power on, the system briefly switches through the outputs on the FL1F-H12SCD. With an open circuit, a voltage of > 8 V can occur for up to approximately 100 ms; when the circuit is loaded, this time reduces to a matter of microseconds.

### IDEC SmartRelay expansion modules, operating states

Expansion modules have three operating states. The color of the LED (RUN/STOP) indicates one of three operating states for expansion modules.

Green (RUN)	Red (STOP)	Orange/Yellow
The expansion module communicates with the device to the left.	The expansion module does <b>not</b> communicate with the device to its left.	Initialization phase of the expansion module



## Getting started with IDEC SmartRelay

Programming refers to creating a circuit program from the Base Module.

In this chapter you will learn how to use IDEC SmartRelay to create the IDEC SmartRelay circuit programs for your application.

WindLGC is the IDEC SmartRelay programming software that you can use on your PC to quickly and easily create, test, modify, save and print the circuit programs. The topics in this manual, however, relate only to the creation of circuit programs on the actual IDEC SmartRelay Base Module. The programming software WindLGC contains extensive online help.

---

### Note

IDEC SmartRelay versions without a display unit, that is, the FL1F-B12RCE, FL1F-B12RCA and FL1F-B12RCC versions, do not have an operator panel and display unit. These devices are ideal for use in small machine and process equipment engineering systems for series production.

You do not program FL1F-B12RCE/B12RCA/B12RCC versions directly on the device. Instead, you download a program to the device from WindLGC or from memory cards with the program you created on another IDEC SmartRelay device.

IDEC SmartRelay versions without a display cannot write data to memory cards.

See Chapters "Using memory cards (Page 273)", "IDEC SmartRelay software (Page 287)" and the Appendix "IDEC SmartRelay without display ("IDEC SmartRelay Pure") (Page 315)" for more information.

---

A small example in the first part of this chapter introduces the operating principles of IDEC SmartRelay:

- You will learn the meaning of two basic terms, namely the **connector** and the **block**.
- As the next step, you will create a circuit program based on a simple conventional circuit.
- Lastly, you will enter this program directly in IDEC SmartRelay.

It will take you only a few pages of this manual to store your first executable circuit program in the IDEC SmartRelay device. With suitable hardware (switches etc.), you will then be able to carry out initial tests.

### 3.1 Connectors

IDEC SmartRelay is equipped with inputs and outputs

Example of a configuration with several modules:

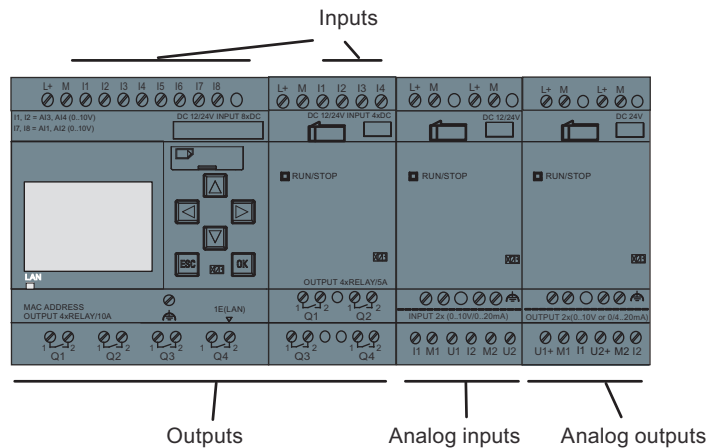

The illustration shows the conceptual usage of the inputs, not the actual physical markings on the module.

The letters I followed by numerals identify the inputs. When you look at IDEC SmartRelay from the front, you can see the input terminals at the top. Only analog input modules FL1F-J2B2 has the inputs at the bottom.

The letters Q followed by numerals (on FL1F-K2BM2) identify the outputs. In the figure, you can see the output terminals at the bottom.

**Note**

IDEC SmartRelay can recognize, read and switch the I/O of all expansion modules regardless of their type. The I/O numbers follow the installation order of the modules.

For IDEC SmartRelay FL1F series, the following I/O and memory markers blocks are available for creating your circuit program from IDEC SmartRelay:

- I1 to I24, AI1 to AI8, Q1 to Q20, AQ1 to AQ8, M1 to M64, and AM1 to AM64
- 32 shift register bits S1.1 to S4.8
- 4 cursor keys C ▲, C ►, C ▼ and C ◀
- four function keys on the FL1F-RD1: F1, F2, F3, and F4
- 64 blank outputs X1 to X64

If you have previously configured any of the network digital or analog inputs/outputs NI1 to NI64, NAI1 to NAI32, NQ1 to NQ64, and NAQ1 to NAQ16 in your circuit program from WindLGC, after downloading the circuit program to IDEC SmartRelay, these network digital or analog inputs/outputs are available in the IDEC SmartRelay; however, you can not edit the rest of the program from the IDEC SmartRelay, except for the Par parameter.

See the "Constants and connectors (Page 113)" topic for more details.

The following applies to inputs I1, I2, I7 and I8 of FL1F-B12RCE/H12RCE and FL1F-H12SCD versions: If you use I1, I2, I7 or I8 in the circuit program, this input signal is digital. If you use AI3, AI4, AI1, or AI2, the input signal is analog. The numbering of the analog inputs is significant: AI1 and AI2 corresponded to I7 and I8. With the addition of two new analog inputs, these modules optionally use I1 for AI3 and I2 for AI4. See the graphical representation in the topic on "Maximum setup with expansion modules (Page 17)". Also note that you can also use I3, I4, I5, and I6 as fast digital inputs.

### IDEC SmartRelay's connectors

The term connector refers to all connections and states in IDEC SmartRelay .

The digital I/O status can be '0' or '1'. Status '0' means that the input does not carry a specific voltage. Status '1' means that the input does carry a specific voltage.

The 'hi' and 'lo' connectors make it easier for you to create the circuit program. 'hi' (high) is assigned the status '1', and 'lo' (low) is assigned the status '0'.

You do not have to use all of the connectors of a block. The circuit program automatically assigns the unused connectors a status that ensures proper functioning of the relevant block.

For information on the meaning of the term "block", refer to the topic on "Blocks and block numbers (Page 52)".

### IDEC SmartRelay has the following connectors :

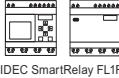
Connectors	 IDEC SmartRelay FL1F	FL1F-M08...	FL1F-J2B2	FL1F-K2BM2	
Inputs	FL1F-H12RCC FL1F-B12RCC FL1F-H12RCA FL1F-B12RCA FL1F-H12RCE FL1F-B12RCE FL1F-H12SCD	Two groups: I1 to I4 and I5 to I8	I9 to I24	AI1 to AI8	none
		I1, I2, I3-I6, I7, I8 AI3, AI4 ... AI1, AI2	I9 to I24	AI5 to AI8	
Outputs	Q1 to Q4	Q5 to Q20	none	AQ1 to AQ8	
lo	Logical '0' signals (off)				
hi	Logical '1' signals (on)				
Memory markers	Digital memory markers: M1 to M64 Analog memory markers: AM1 to AM64				
Shift register bits	S1.1 to S4.8				
Network inputs <sup>1)</sup>	NI1 to NI64				
Network analog inputs <sup>1)</sup>	NAI1 to NAI32				
Network outputs <sup>1)</sup>	NQ1 to NQ64				
Network analog outputs <sup>1)</sup>	NAQ1 to NAQ16				

**DM:** Digital Module

**AM:** Analog Module

<sup>1)</sup> To make these four connectors available in an IDEC SmartRelay module, you must configure them in the circuit program with WindLGC V8.0 or later version and download the circuit program to the IDEC SmartRelay.

### 3.2 Blocks and block numbers

This chapter shows you how to use IDEC SmartRelay elements to create complex circuits and how blocks and I/O are interconnected.

In the topic "From circuit diagram to IDEC SmartRelay program (Page 55)" you will learn how to transform a conventional circuit into an IDEC SmartRelay circuit program.

#### Blocks

A block in IDEC SmartRelay represents a function that is used to convert input information into output information. Previously you had to wire the individual elements in a control cabinet or terminal box. When you create the circuit program, you interconnect the blocks.

#### Logic operations

The most elementary blocks are the logic operations:

- AND
- OR
- ...

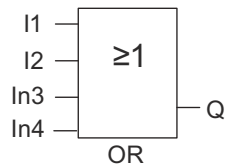

Inputs I1 and I2 connect to the OR block. The last two inputs of the block remain unused.

These special functions offer you significantly greater performance:

- Current impulse relay
- Up/down counter
- On-delay
- Softkey
- ....

The chapter entitled "IDEC SmartRelay functions (Page 113)" gives a full list of the IDEC SmartRelay functions.

### Block representation on the IDEC SmartRelay onboard display

The figure below shows a typical view of the IDEC SmartRelay onboard display. As you can see, it can show only one block at a time. IDEC SmartRelay shows the block number on the top of the display by default if you assign no name to this block. The block numbers help you check the circuit structure. Alternatively, you can also choose to display a customized block name instead of the block number. For more information about assigning a block name, refer to Section "Circuit program input (Page 65)".

View of the IDEC SmartRelay display

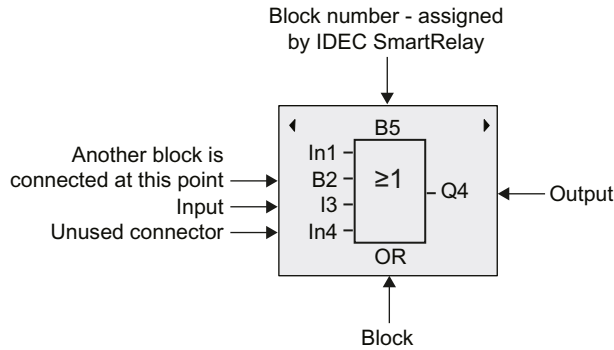

### Assigning a block number

IDEC SmartRelay automatically assigns each new block in a circuit program a block number. IDEC SmartRelay uses these block numbers to indicate the block interconnections. This means that these numbers are mainly an aid to your orientation in the circuit program.

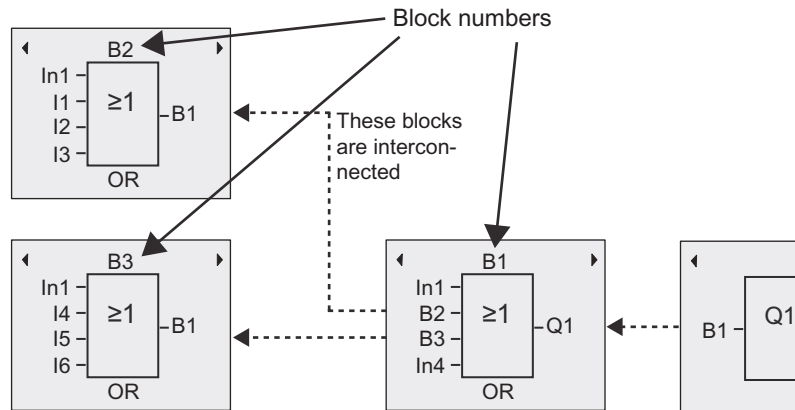

The figure above shows you three views of the IDEC SmartRelay onboard display, which represent the circuit program. As you can see, IDEC SmartRelay interconnects the blocks using their numbers. To scroll the circuit program, use the keys ◀ or ▶.



### **Advantages of block numbers**

You can connect almost any block to an input of the current block by means of its block number. In this way, you can reuse the interim results of logical or other operations, reduce programming effort, save memory space and clean up your circuit layout. To do so, however, you need to know how IDEC SmartRelay has named the blocks.

---

#### **Note**

An organizational program chart can be a valuable aid when you create the circuit program because you can enter in this chart all the block numbers that IDEC SmartRelay assigns.

By using the WindLGC software to program IDEC SmartRelay, you can directly create a function chart of your circuit program. WindLGC also allows you to assign 12-character names to up to 100 blocks, and to view these on the IDEC SmartRelay onboard display in parameter assignment mode. See the topic "The four golden rules for operating IDEC SmartRelay (Page 57)".

---

### 3.3 From circuit diagram to IDEC SmartRelay program

#### View of a circuit diagram

The following illustration shows a typical circuit diagram that represents the circuit logic:

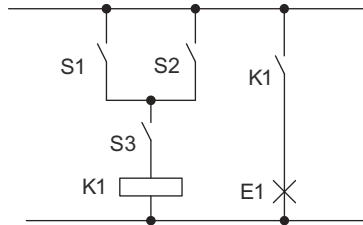

The switches (S1 OR S2) AND S3 activate the relay K1 and switch on the load at E1.

#### Creating this circuit with IDEC SmartRelay

In IDEC SmartRelay you create a circuit logic by interconnecting blocks and connectors:

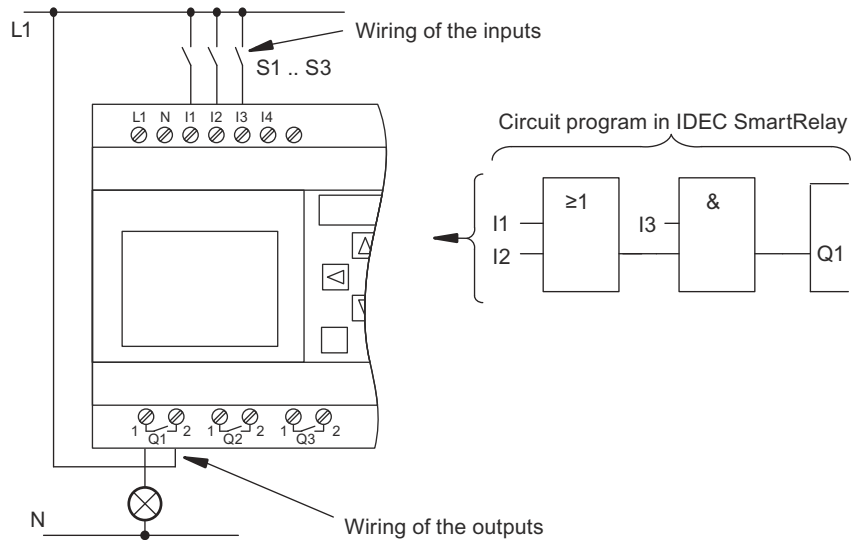

#### Note

Although you have four inputs available for Basic functions list - GF (Page 118), most of the views only show three inputs for reasons of clarity. You program this fourth input and assign parameters just like you do with the other three inputs.

To create a new circuit logic in IDEC SmartRelay, start at the circuit output.

The output is the load or relay that is to be switched.

Convert the circuit logic into blocks by working through the circuit, starting at the output and ending at the input:

Step 1: Connect the normally open contact S3 in series with another circuit element to output Q1. A series connection corresponds to the AND block:

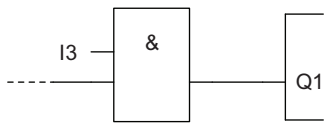

Step 2: Use an OR block to connect S1 and S2 in parallel. A parallel circuit corresponds to the OR block:

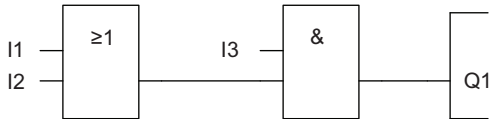

### Unused inputs

The circuit program automatically assigns the unused connectors a status that ensures proper functioning of the relevant block.

In our example we shall use only two inputs of the OR block and two inputs of the AND block; the third and fourth inputs are unused.

Now connect the I/O to IDEC SmartRelay.

### Wiring

Connect the switches S1 to S3 to the screw terminals of your IDEC SmartRelay :

- S1 to connector I1 of IDEC SmartRelay
- S2 to connector I2 of IDEC SmartRelay
- S3 to connector I3 of IDEC SmartRelay

The output of the AND block controls the relay at output Q1. The load E1 connects to output Q1.

## Wiring example

The following figure shows you the wiring, based on a 100-240 VAC/VDC version of IDEC SmartRelay.

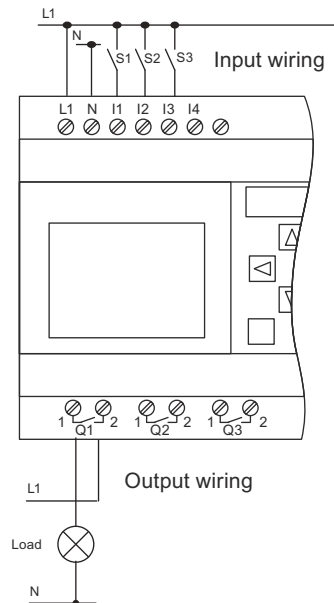

## 3.4 The four golden rules for operating IDEC SmartRelay

### Rule 1: Changing the operating mode

- You create the circuit program in programming mode. After power is on, and when the program is empty in IDEC SmartRelay, IDEC SmartRelay selects the programming mode by default.
- You can edit timer and parameter values of an existing circuit program in both **parameter assignment mode** and **programming mode**. During **parameter assignment** IDEC SmartRelay is in **RUN mode**; that is, it continues executing the circuit program (see the topic "Configuring IDEC SmartRelay (Page 259)"). To work in **programming mode**, you need to terminate the circuit program.
- Select the menu command  on the main menu to set **RUN mode**.
- When the system is in **RUN mode**, you can return to **parameter assignment mode** by pressing the **ESC** key.
- When **parameter assignment mode** is open and you want to return to **programming mode**, select the menu command  from the parameter assignment menu to set **STOP mode**.

For more details on operating modes, refer to the Appendix topic "IDEC SmartRelay menu structure (Page 317)".

## Rule 2: Outputs and inputs

- Always create your circuit program by working from the output to the input.
- You can connect an input to several outputs, but not the same output to several inputs.
- Within the same program path you cannot connect an output to an upstream input. You can use markers or outputs for such internal recursions.

## Rule 3: Cursor and cursor movement

The following applies when you edit a circuit program:

- You can move the cursor when it appears as a solid square:
  - Press ◀, ▶, ▼ or ▲ to move the cursor in the circuit program.
  - Press **OK** to change to select connector/block.
  - Press **ESC** to exit programming mode.
- You select a connector/block when the cursor appears as a solid square:
  - Press ▼ or ▲ to select a connector or a block.
  - Confirm with **OK**.
  - Press **ESC** to return to the previous step.

## Rule 4: Planning

- Before you start to create a circuit program, first create a design on paper or program IDEC SmartRelay directly using WindLGC.
- IDEC SmartRelay can only save complete and faultless circuit programs.

## 3.5 Configuring menu access protection for IDEC SmartRelay

IDEC SmartRelay provides two access levels, administrator and operator, to limit access to specific menus in programming mode. As an administrator, you can access all menu commands; while as an operator, some specific menu commands are not visible (see section "Overview of IDEC SmartRelay menus (Page 61)"). IDECE SmartRelay's default setting is administrator at delivery, and you can switch to operator at any time. When switching from operator to administrator, you need to enter a valid password ("IDEC" by default). IDECE SmartRelay always saves its access level before power-off.

### Note

The access level of the Text Display is operator by default, and you can switch it to administrator with the password (the default password is "IDEC").

The Text Display saves its access level before power-off if it connects to the same Base Module after power-on. If you connect a different Base Module to it, however, the Text Display restores its access level to operator after power-on.

### Switching IDECE SmartRelay from administrator to operator

To switch IDECE SmartRelay's access level from administrator to operator, follow these steps:

1. Move the cursor to " ① " on the main menu of programming mode: Press ▲ or ▼

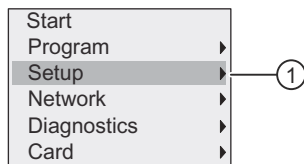

2. Confirm " ① ": Press OK.
3. Move the cursor to " ② ": Press ▲ or ▼.

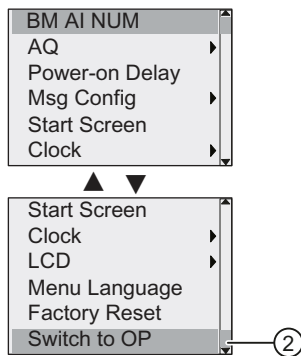

4. Confirm " ② ": Press OK.

IDECE SmartRelay now switches to the access level of operator and returns to the main menu.

### Switching IDEC SmartRelay from operator to administrator

To switch IDEC SmartRelay's access level from operator to administrator, follow these steps:

1. Move the cursor to " ① " on the main menu of programming mode: Press ▲ or ▼

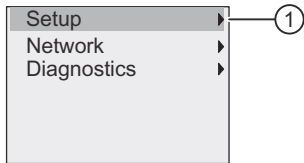

2. Confirm " ① ": Press **OK**.
3. Move the cursor to " ② ": Press ▲ or ▼.

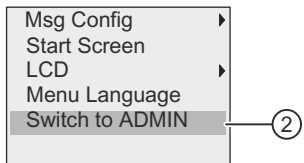

4. Confirm " ② ": Press **OK**. The display appears as follows:

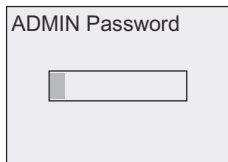

5. Press ▲ or ▼ to move up and down the alphabet to select your letters (for example, "IDEC").

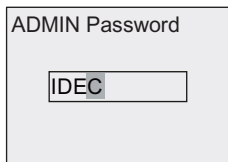

6. Confirm the password: Press **OK**.

IDEC SmartRelay now switches to the access level of administrator and returns to the main menu.

### 3.6 Overview of IDEC SmartRelay menus

The following illustration shows an overview of IDEC SmartRelay menus:

Programming mode

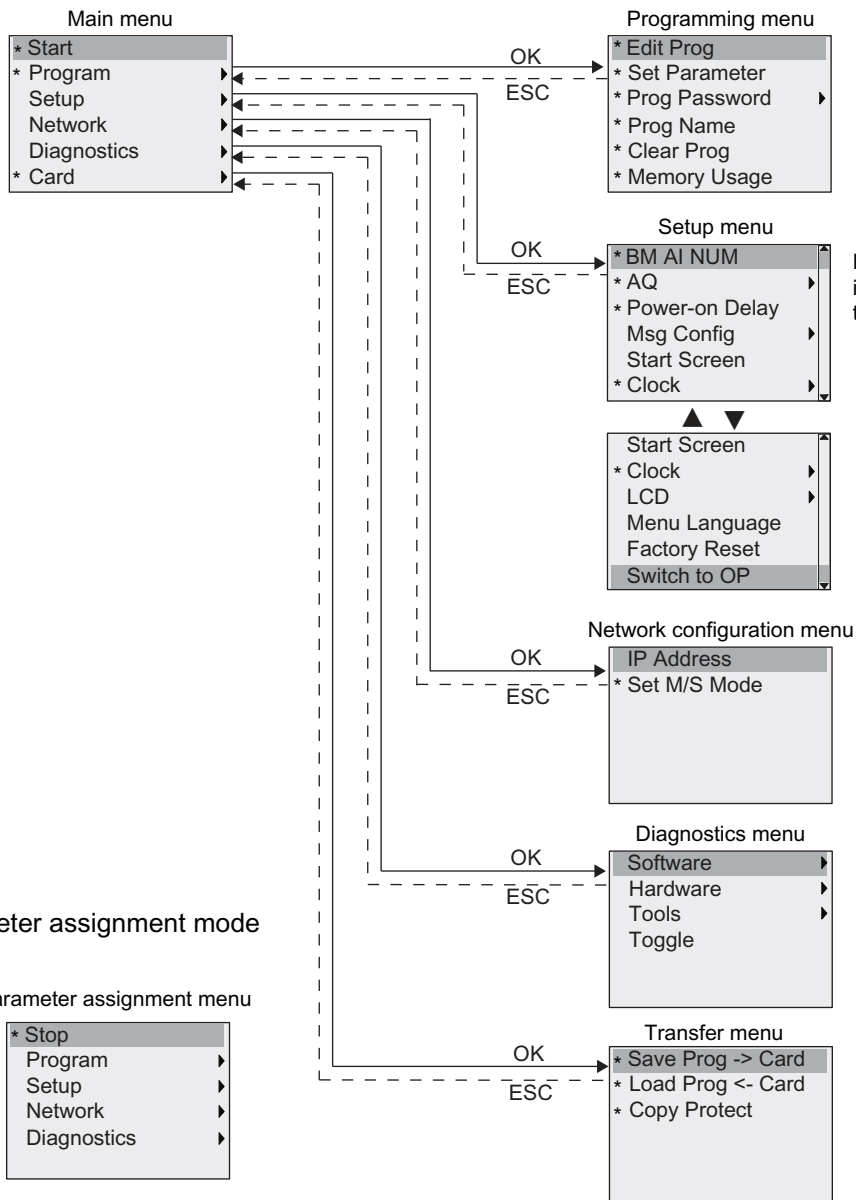

Parameter assignment mode

\* These menu commands are visible only with the access level of administrator.  
For more details on the menus, refer to the Appendix "Base Module (Page 317)".

The following illustration shows an overview of Text Display menus:



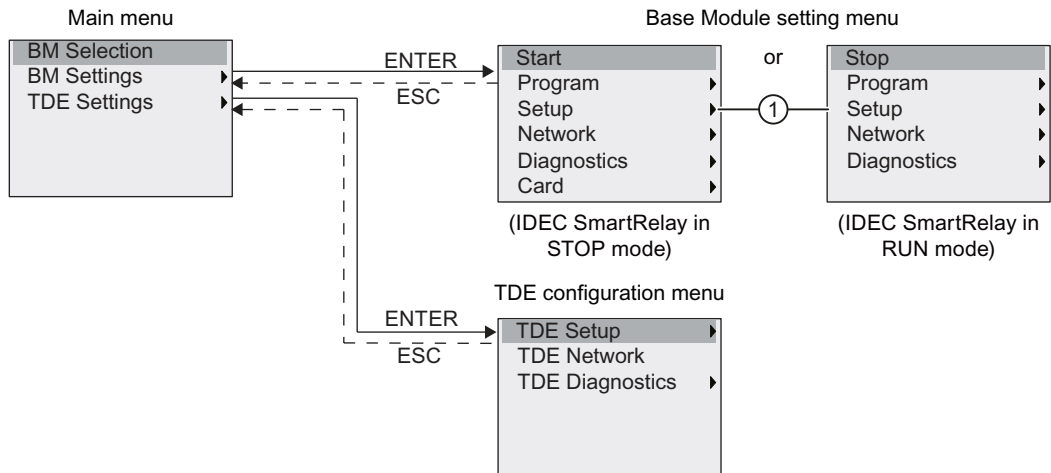

The Text Display provides three menus as follows:

- The Base Module selection menu  
You can use this menu to select a connected Base Module by entering a specific IP address.
- The Base Module setting menu  
You can use this menu to perform the remote setting of the connected Base Module. This menu has almost the same menu commands as those on the Base Modules, except for the menu commands under " ① ". The menu commands for setting the start screen, message text, contrast and backlight, and menu language for the Base Module are not available on the Text Display.
- The TDE configuration menu  
You can use this menu to perform the independent configuration of the Text Display.

For more details on the menus, refer to the Appendix "Text Display (Page 322)".

## 3.7 Writing and starting the circuit program

The example below shows how to create a program for your circuit design in IDEC SmartRelay.

### 3.7.1 Selecting programming mode

When you connect IDEC SmartRelay to the power supply and switch it on, the display shows you the main menu of the programming mode:

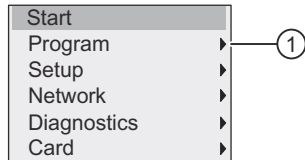

The first line is highlighted. Press ▲ and ▼ to move the highlight bar up and down. Move it to " ① " and confirm with **OK**. IDEC SmartRelay opens the programming menu.

The **IDEC SmartRelay's programming menu** is as shown below:

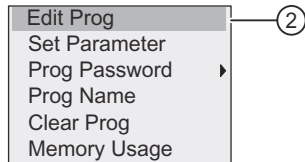

Here you can also move the highlight bar by pressing ▲ and ▼. Move the highlight bar to " ② " and confirm with **OK**.

You are now in the circuit program window. Press **OK** to enter the program editing mode, and the cursor appears as a solid square at the "NEW" block. The display now shows as follows:

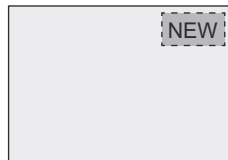

Confirm with **OK** and IDEC SmartRelay now shows you the first output:

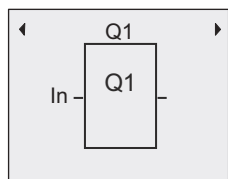

You are now in programming mode. Press ▲ and ▼ to select the other outputs. Now you can start to edit your circuit program.

**Note**

Because you have not yet saved a **password** for the circuit program in IDEC SmartRelay, you can directly enter editing mode. When you select to edit the program after you have saved a password-protected circuit program, IDEC SmartRelay prompts you to enter a password and to confirm it with **OK**. You can only edit the program after you have entered the correct Password for circuit program protection (Page 70).

If you have created your circuit program in IDEC SmartRelay, you can view it in the circuit program window by moving cursor on the blocks. IDEC SmartRelay can display a maximum of 31\*31 blocks in the circuit program window.

### 3.7.2 The first circuit program

The following parallel circuit consists of two switches.

#### Circuit diagram

The corresponding circuit diagram shows as follows:

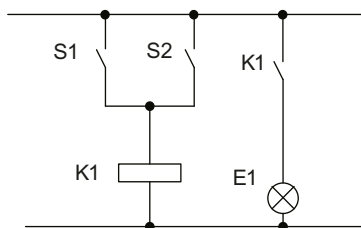

The switch S1 OR S2 turns on the load. IDEC SmartRelay interprets this parallel circuit as an 'OR' logic, because S1 OR S2 switches on the output.

Translated into an IDEC SmartRelay circuit program, you use an OR block to control relay K1 at output Q1.

#### Circuit program

Switch S1 connects to input I1 and switch S2 connects to input I2. Inputs I1 and I2 connect to the OR block connectors.

The corresponding layout of the circuit program in IDEC SmartRelay shows as follows:

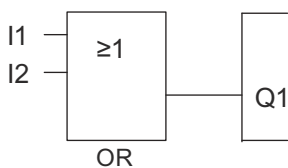

## Wiring

The corresponding wiring shows as follows:

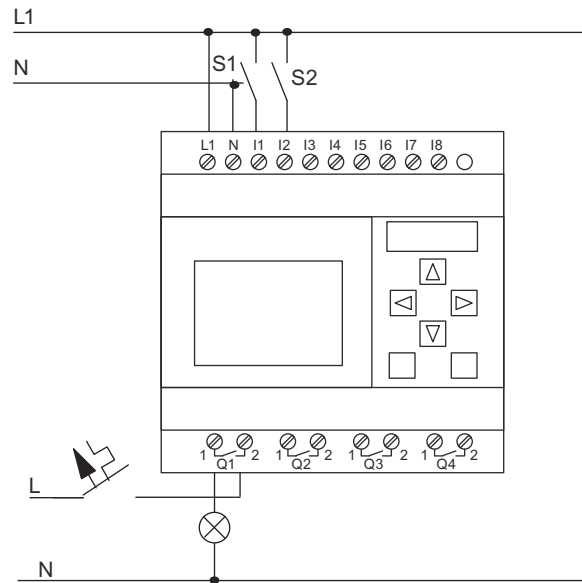

S1 switches input I1, while S2 switches input I2. The load connects to the relay Q1.

### 3.7.3 Circuit program input

You can now write the circuit program, starting at the output and working towards the input. IDEC SmartRelay initially shows the output:

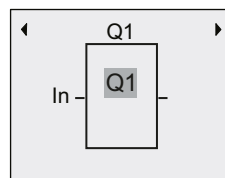

The first IDEC SmartRelay output

You will see a solid square at Q1, which is the **cursor**. The cursor indicates your current position in the circuit program. You can move the cursor by pressing the ▲, ▼, ◀ and ▶ keys. Now press the ◀ key. The cursor moves to the left.

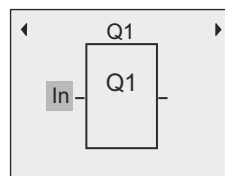

The cursor indicates your current position in the circuit program.

At this point you enter only the first (OR) block. Press **OK** to select editing mode.

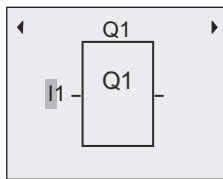

The cursor is displayed as a flashing solid square: you can now select a connector or a block

The cursor now appears as a flashing solid square. IDEC SmartRelay offers you various options here.

Select GF (basic functions) by pressing the **▼** key until GF appears, and confirm with **OK**. IDEC SmartRelay now shows the first block from the list of basic functions:

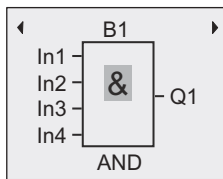

The AND is the first block of the basic function list. The solid square cursor prompts you to select a block.

Press **OK** to select editing mode, which causes IDEC SmartRelay to display the cursor as a flashing solid square. Now press **▼** or **▲** until the OR block appears on the display:

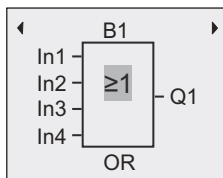

The flashing solid square cursor still appears on the block.

Press **OK** to confirm your entries and exit the dialog.

The display now shows:

Your complete circuit program layout

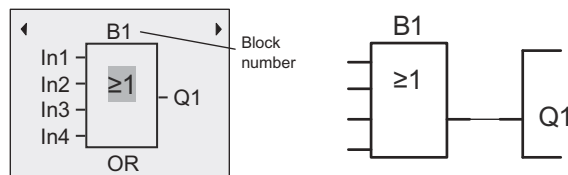

You have now entered the first block. IDEC SmartRelay automatically assigns a block number to each new block. If you assign a name to the block, IDEC SmartRelay shows the block name instead of the block number. You can assign a block name as required:

Press **▲** to move the cursor to "B1".

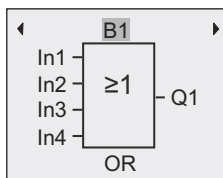

Press **OK** and the cursor is now displayed as a flashing solid square. Now you can press **▼** and **▲** to list the alphabet, numbers and special characters, either in ascending or descending order. For more information on the available character set, refer to Section "Assigning a circuit program name (Page 69)".

After you complete the change, press **OK** to confirm.

You then connect the block inputs as follows:

Press **◀** to position the cursor on In1 and press **OK** to select editing mode.

Press **▼** or **▲** to select the digital input list. The first element of the digital input list is the "Input 1", namely "I1". You can press **▶** to move the cursor to the input number, and then use **▼** or **▲** to select the desired input (I1 to I24).

The display now shows:

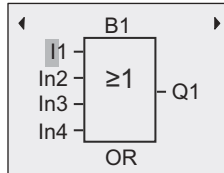

**Note**

Inputs F1, F2, F3, and F4 correspond to the four function keys on the optional Text Display.

More shift register bits (S1.1 to S4.8), blank connectors (X1 to X64) and analog memory markers (AM1 to AM64) are available in the FL1F device series.

Network digital inputs (NI1 to NI64), network analog inputs (NAI1 to NAI32), network digital outputs (NQ1 to NQ64), and network analog outputs (NAQ1 to NAQ16) are available for the FL1F device series. IDEC SmartRelay does not include these inputs and outputs until you configure them in a circuit program in WindLGC V8.0 or later and download the program to your IDEC SmartRelay.

After selecting I1, the display now shows as follows:

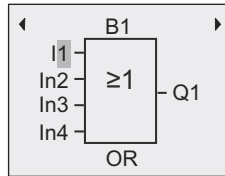

Press **OK** to confirm. You have now connected I1 to the input of the OR block.

The display now shows:

Your complete circuit program in IDEC SmartRelay up to now:

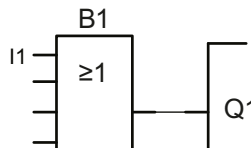
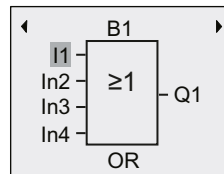

Now you connect input I2 to the input of the OR block:

1. Move the cursor to In2: Press **▼** or **▲**.
2. Switch to editing mode: Press **OK**.
3. Select the digital input list: Press **▼** or **▲**.
4. Move the cursor to the input number: Press **▶**.
5. Select **I2**: Press **▼** or **▲**.
6. Apply I2: Press **OK**.

You have now connected I2 to the second input of the OR block:

The display now shows:

Your complete circuit program in IDEC SmartRelay up to now:

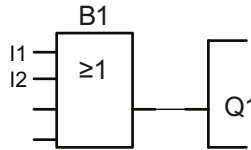
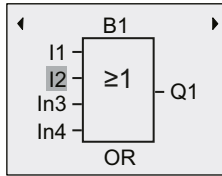

**Note**

You can invert individual inputs of the basic and special functions; that is, if an input carries a logical "1" signal, you can cause the circuit program to output a logical "0". You can also cause IDEC SmartRelay to invert a logical "0" signal to a logical "1".

To invert an input, move the cursor to the relevant position, for example:

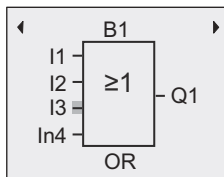

Confirm with **OK**.

Now press ▲ or ▼ to invert this input: ➔

Next, press **ESC**.

Your circuit program layout:

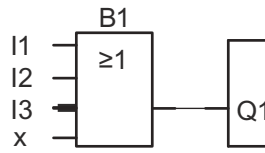
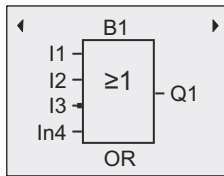

You can review your first circuit program by pressing ◀ or ▶ to move the cursor through the circuit program.

To exit circuit programming mode and return to the programming menu, press **ESC**

**Note**

IDEC SmartRelay has now saved your circuit program to nonvolatile memory. The circuit program remains in the IDEC SmartRelay memory until you explicitly delete it.

You can save the actual values of special functions in the case of a power outage assuming that these functions support the "Retentive" parameter and that the necessary program memory is available. By default, IDEC SmartRelay deactivates the "Retentive" parameter when you insert a function; to use it, you must enable this option.

### 3.7.4 Assigning a circuit program name

You can assign your circuit program a name that consists of up to 16 uppercase/lowercase letters, numbers and special characters.

1. In the main menu in programming mode, press ▼ or ▲ to move the cursor to " ① ".

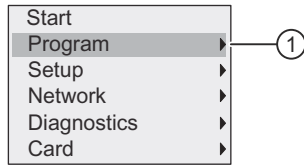

2. To confirm " ① ", press **OK**.
3. Press ▼ or ▲ to move the cursor to " ② ".

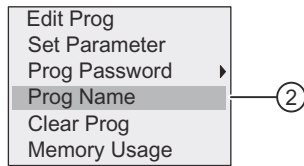

4. To confirm " ② ", press **OK**.

Press ▲ and ▼ to list the alphabet, numbers and special characters, either in ascending or descending order. You can select any letter, number or character.

To enter a space character, simply move the cursor with ► to the next position. This character is the first one in the list.

Examples:

Press ▲ once to select an "A". Press ▲ four times to select "D", etc.

The following character set is available:

	A	B	C	D	E	F	G	H	I	J	K	L	M	N	O
P	Q	R	S	T	U	V	W	X	Y	Z	0	1	2	3	4
5	6	7	8	9	!	"	#	\$	%	&	'	(	)	*	+
,	-	.	/	:	;	<	=	>	?	@	[	\	]	^	_
`	{		}	~	a	b	c	d	e	f	g	h	i	j	k
l	m	n	o	p	q	r	s	t	u	v	w	x	y	z	

Assuming that you want to name your circuit program "ABC", follow these steps:

1. Select "A": Press ▲.
2. Move to the next letter: Press ►.
3. Select "B": Press ▲.
4. Move to the next letter: Press ►.
5. Select "C": Press ▲.
6. Confirm the complete name: Press **OK**.



Your circuit program is now named "ABC", and IDEC SmartRelay returns to the programming menu.

To **change** the name of your circuit program, proceed in the same way.

---

**Note**

You can change the name of the circuit program in programming mode only. If you have saved a password-protected circuit program, you can change the name of the circuit program only after you have entered the correct password (refer to Section "Password for circuit program protection (Page 70)"). You can **read** the name in both programming mode **and** parameter assignment mode.

---

### 3.7.5 Password for circuit program protection

You can protect a circuit program from unauthorized access by assigning it a password.

You can assign, change, or deactivate a program password from a Base Module, WindLGC or a Text Display.

---

**Note**

There is only one circuit program protection password that you can assign for IDEC SmartRelay.

---

#### Assigning a program password from Base Module

A password can have a maximum length of 10 characters, and consists only of uppercase letters. On Base Module, you can assign, edit or deactivate the password only in the programming mode.

To enter a password, follow these steps in the programming menu:

1. Move the cursor to " ① ": Press ▼ or ▲.

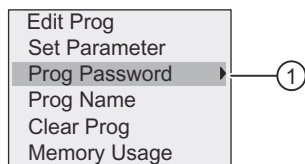

2. Confirm " ① ": Press OK.
3. Move the cursor to " ② ": Press ▼ or ▲.

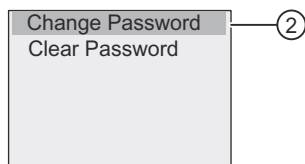

4. Confirm " ② ": Press **OK**.
5. Press ▼ or ▲ to move up and down the alphabet to select your letters. Because Base Module only provides uppercase letters for the password, you can quickly access letters "at the end" of the alphabet (in this example, English) by using the ▼ button:

Press ▼ once to select "Z".

Press ▼ twice to select "Y", etc.

The display appears as follows:

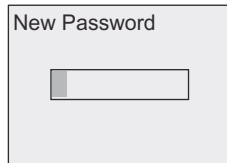

To enter a password of "AA", for example, the procedure is the same as for entering the name of the circuit program.

6. Select "A": Press ▲.
7. Move to the next letter: Press ►.
8. Select "A": Press ▲.

The display now appears as follows:

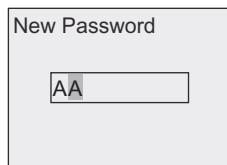

9. Confirm the password: Press **OK**.

You have now protected your circuit program with the password "AA" and IDEC SmartRelay returns to the programming menu.

---

#### **Note**

You can cancel the input of a new password with **ESC**. In this case, Base Module returns to the programming menu without saving the password.

You can also set your password using WindLGC or Text Display. You cannot edit a password-protected circuit program in a Base Module or upload it to WindLGC unless you enter the correct password.

To allow you to create and edit a circuit program for a protected module (Card), you first need to Program copy protection (Page 284).

---

### Changing the password from Base Module

You must know the current password in order to change it. From the programming menu, follow these steps to change the password:

1. Move the cursor to " ① ": Press ▼ or ▲.

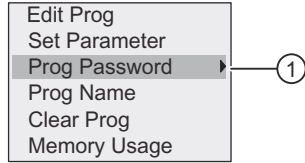

2. Confirm " ① ": Press **OK**.

The display now shows:

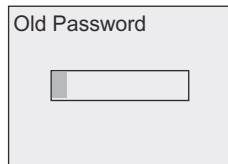

Enter your old password (in our case: 'AA') by repeating steps 5 through 9 as described earlier. Press **OK**.

Now you can enter the new password, for example, "ZZ".

3. Move the cursor to " ② ": Press ▼ or ▲.

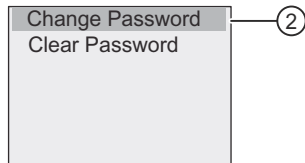

4. Confirm " ② ": Press **OK**.
5. Select "Z": Press ▼.
6. Move to the next letter: Press ►.
7. Select "Z": Press ▼.
8. Confirm your new password: Press **OK**.

You have now set the password to "ZZ", and IDEC SmartRelay returns to the programming menu.

## Deactivating the password from Base Module

To deactivate the password to allow, for example, another user to edit your circuit program, you must know your current password (in our example "ZZ").

To deactivate the password, follow these steps in the programming menu:

1. Move the cursor to " ① ": Press ▼ or ▲.

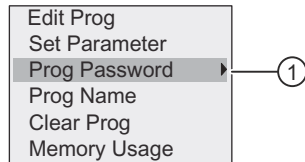

2. Confirm " ① ": Press OK.

Enter your current password as described in steps 5 to 7 above. Confirm your entries with OK.

3. Move the cursor to " ② ": Press ▼ or ▲.

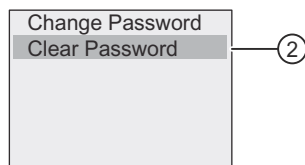

4. Confirm " ② ": Press OK.

The display now shows:

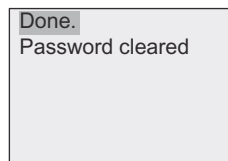

Alternatively, you can also select " ③ " and clear the password by leaving the input box blank.

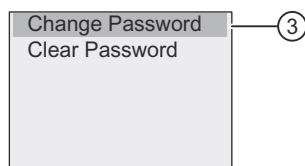

5. Press any key and IDEC SmartRelay returns to the programming menu. You have now cleared the password.

---

### Note

This action disables the password prompt, and thus permits access without a password.

Leave the password **deactivated** for quicker progress through the remaining exercises and examples.

---

### Password: Wrong Password!

If you enter the **wrong** password and confirm the input with **OK**, Base Module does not open editing mode, and the display shows as follows:

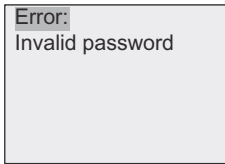

In this case, press any key and IDEC SmartRelay returns to the programming menu. This repeats itself over and over again until you enter the correct password.

### 3.7.6 Switching IDEC SmartRelay to RUN mode

To switch IDEC SmartRelay to RUN mode, follow these steps:

1. Return to the main menu: Press **ESC**.
2. Move the cursor to " ① ": Press **▲** or **▼**.

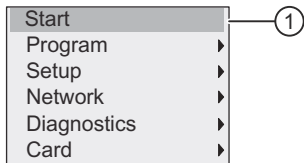

3. Confirm " ① ": Press **OK**. The display now shows:

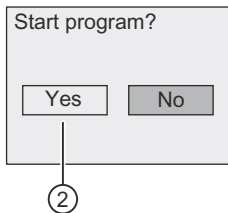

4. Press **◀** to move the cursor to " ② " and press **OK**.

IDEC SmartRelay runs the circuit program and shows the following display:

The start screen of IDEC SmartRelay displays one of the following:

- Date and current time-of-day (only for versions with real-time clock). This element flashes if you have not set the date and time.
- Digital inputs
- Parameter assignment menu

You can select the default setting for the start screen that IDEC SmartRelay displays in RUN mode. For more information, see Section "Setting the start screen (Page 271)".

Display field of IDEC SmartRelay in RUN mode

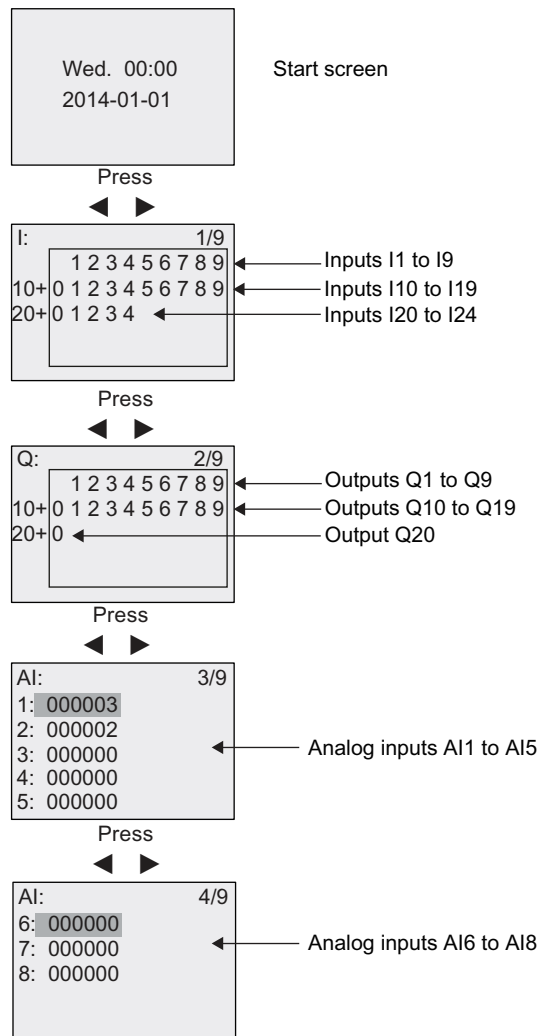

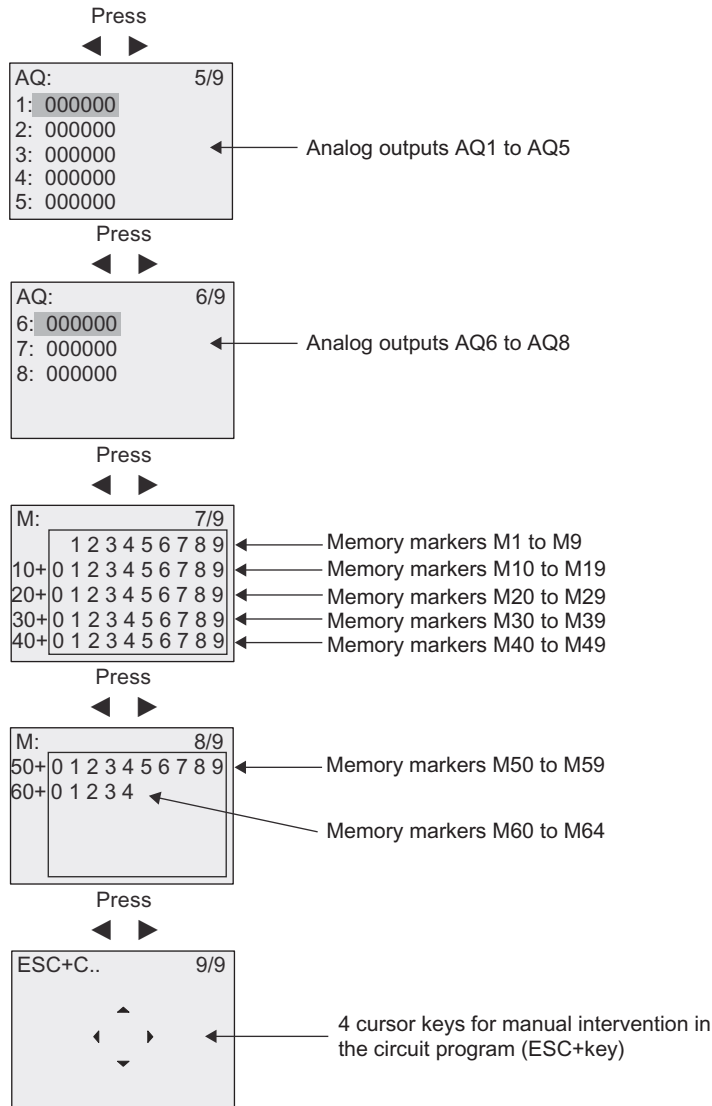

### Viewing the analog value changes

You can view the value changes of each analog I/O in the form of a trend curve when IDEC SmartRelay is in RUN mode. For example, to view the value changes of AI3, follow these steps:

1. Switch IDEC SmartRelay to RUN mode.
2. Scroll the display to the AI screen form (3/9): Press ◀ or ▶.

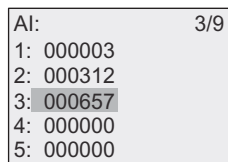

3. Move the cursor to AI3: Press ▲ or ▼.

- Press **OK** to confirm your selection. The display now shows the AI3 value changes in the form of a curve, for example:

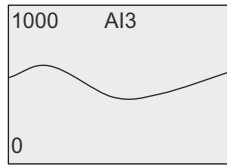

The display refreshes continuously and the curve shifts to the left of the display bit by bit. You can press ◀ or ▶ to move the screen form to the left/right in order to view the earlier/ later value changes.

### What is meant by: "IDEC SmartRelay is in RUN"?

In RUN mode, IDEC SmartRelay executes the circuit program. IDEC SmartRelay first reads the status at the inputs, determines the status of the outputs by means of the circuit program, and switches these on or off according to your settings.

This is how IDEC SmartRelay indicates the I/O status:

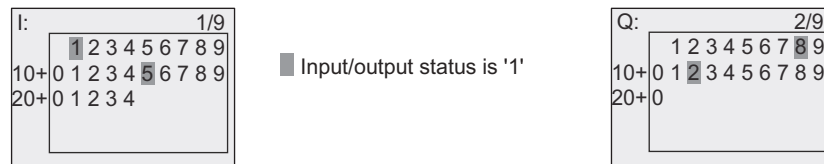

In this example, only the inputs I1 and I15 and the outputs Q8 and Q12 are set "high".

### Status indication on the display

Using the example, you can see how IDEC SmartRelay displays the input and output states:

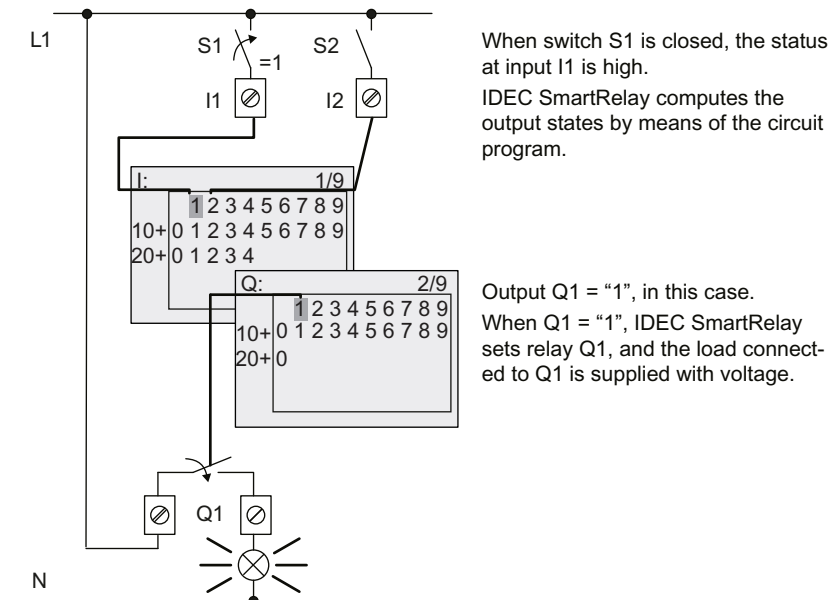

When switch S1 is closed, the status at input I1 is high. IDEC SmartRelay computes the output states by means of the circuit program.

Output Q1 = "1", in this case. When Q1 = "1", IDEC SmartRelay sets relay Q1, and the load connected to Q1 is supplied with voltage.



### 3.7.7 Second circuit program

Up to this point, you have successfully created your first circuit program, assigned it a name, and optionally a program password. In this section you will learn how to modify existing circuit programs and how to use the special functions.

Using this second circuit program, you will learn how to perform the following tasks:

- Add a block to an existing circuit program
- Select a block for a special function
- Assign parameters

#### Modifying circuits

You will use the first circuit program as a basis for the second, with some slight modifications.

First of all take a look at the circuit diagram for the second circuit program:

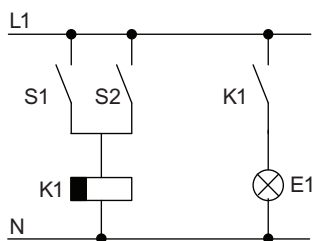

You already know the first part of the circuit. S1 and S2 switch a relay, which is to be used to switch on the load E1, and to switch off the load with a delay of 12 minutes.

This is the circuit program layout in IDEC SmartRelay:

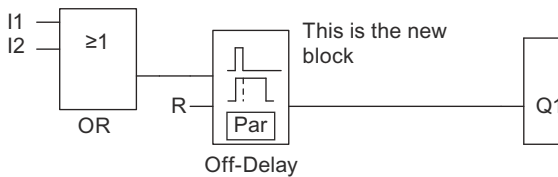

You can see the OR block and the output relay Q1 that you used in the first circuit program. The only difference is the new off-delay block.

#### Editing the circuit program

Follow these steps to edit the circuit program:

1. Switch IDEC SmartRelay to programming mode. For additional details, see the topic "The four golden rules for operating IDEC SmartRelay (Page 57)".
2. On the main menu, move the cursor to " ① ": Press ▲ or ▼.

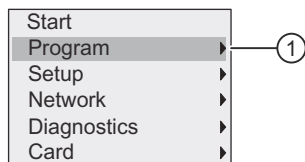

3. Confirm " ① ": Press **OK**. The display now shows:

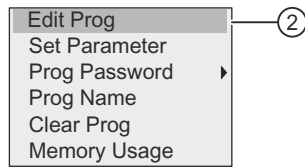

4. On the programming menu, move the cursor to " ② ": Press **▲** or **▼**.

5. Confirm " ② ": Press **OK**. If required, enter your password at the prompt and confirm with **OK**.

6. In the circuit program window, press **OK** to activate the cursor as a solid square.

You can now modify the current circuit program.

### Adding a block to a circuit program

Press **◀** to move the cursor to B1 (B1 is the number of the OR block):

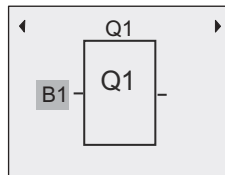

Insert the new block at this position.

Confirm with **OK**, and the cursor appears as a flashing solid square.

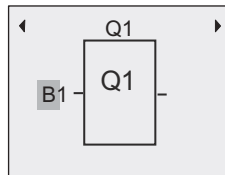

Press **▼** twice to select the SF list. The SF list contains the special function blocks.

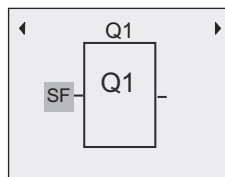

Press **OK**.

IDEC SmartRelay displays the block of the first special function:

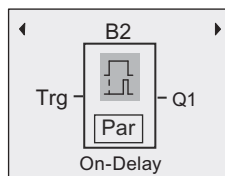

When you select a special or basic function block, IDEC SmartRelay shows you the relevant function block and positions the solid square cursor on the block. Press **OK** to enter the editing mode, and the cursor appears as a flashing solid square. Press **▲** or **▼** to select the required block.

Select your block (off-delay, see the next figure), and then press **OK**:

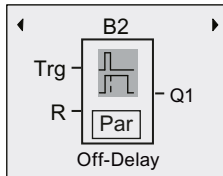

IDEC SmartRelay assigns the block number B2 to the block that you added.

Press **◀** to move the cursor to Trg, and then press **OK**.

Press **▲** or **▼** to select B1 and confirm with **OK**.

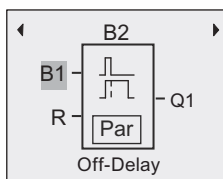

IDEC SmartRelay automatically connects the uppermost input of the new block to B1, which you had previously connected to Q1. Note that you can only interconnect digital inputs with digital outputs or analog inputs with analog outputs. IDEC SmartRelay otherwise removes the 'old' block.

The off-delay block has two inputs and a parameter. At the top is the trigger input (Trg) you use to start the off-delay time. In our example, the OR block B1 triggers the off-delay. You reset the time and the output with a signal at the reset input (R). You set the off-delay time at parameter T of the Par.

### Assigning block parameters

Now you set the off-delay time T:

1. Move the cursor to **Par**: Press **▶**
2. Switch to editing mode: Press **OK**

IDEC SmartRelay shows the parameters in the parameter assignment window:

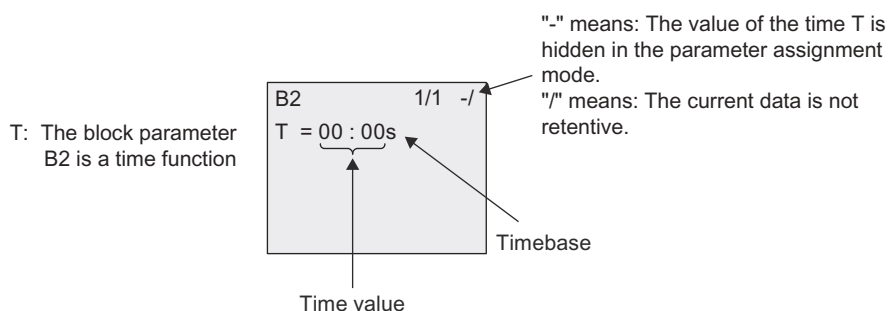

To change the time value, follow these steps:

1. Move the cursor to the time value: Press **▼**.

2. Switch to editing mode: Press **OK**.
3. Press ◀ and ▶ to position the cursor.
4. Press ▲ and ▼ to modify the value at the relevant position.
5. Confirm your entries with **OK**.

### Setting the time

Set the time T = 12:00 minutes:

1. Move the cursor to the first digit: Press ◀ or ▶.
2. Select the digit "1": Press ▲ or ▼.
3. Shift the cursor to the second digit: Press ◀ or ▶.
4. Select digit "2": Press ▲ or ▼.
5. Move the cursor to the unit: Press ◀ or ▶.
6. Select the timebase "m" (for minutes): Press ▲ or ▼.
7. Confirm your entries with **OK**.

### Showing/hiding parameters - the parameter protection mode

If you want to show/hide the parameter and allow/prevent its modification in parameter assignment mode, follow these steps:

1. Move the cursor to "-/": Press ▲ or ▼.
2. Switch to editing mode: Press **OK**.
3. Select the protection mode: Press ▲ or ▼.

The display should now show:

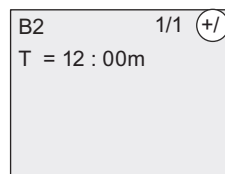

or

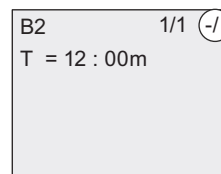

When the protection mode shows "+", you can modify the time T in parameter assignment mode.

When the protection mode shows "-", you cannot modify the time T in parameter assignment mode.

4. Confirm your entries with **OK**.

### Enabling/disabling retentivity

To decide whether you want to retain your current data after a power failure or not, follow these steps:

1. Move the cursor to "-/": Press ▲ or ▼.
2. Switch to editing mode: Press **OK**.
3. Move the cursor to the retentivity setting: Press ◀ or ▶.
4. Select the retentivity setting: Press ▲ or ▼.

The display now shows:

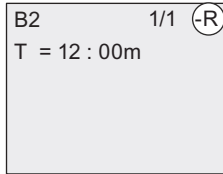

or

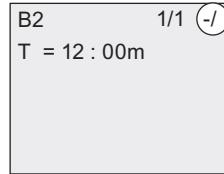

Retentivity R: Current data is retentive.

Retentivity /: Current data is not retentive.

5. Confirm your entries with **OK**.

---

#### Note

For further information on the protection mode, refer to the topic "Parameter protection (Page 127)".

For further information on retentivity, refer to the topic "Retentivity (Page 127)".

You can modify the protection mode and retentivity setting only in programming mode. This is **not** possible in parameter assignment mode.

IDEC SmartRelay displays protection mode ("+" or "-") and retentivity ("R" or "/") settings only where you can actually change these settings.

---

### Verification of the circuit program

You have now completed the program branch for Q1 and IDEC SmartRelay shows you the output Q1. You can once again view the circuit program on the display. Use the keys to browse the circuit program; that is, press ◀ or ▶ to move from block to block, ▲ and ▼ to move between the inputs at a block.

### Closing the programming mode

When you finish programming, you can exit the programming mode by following these steps:

1. Return to the programming menu: Press **ESC**.
2. Return to the main menu: Press **ESC**.
3. Move the cursor to " ① ": Press **▲** or **▼**.

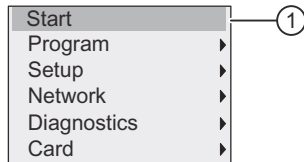

4. Confirm " ① ": Press **OK**.

IDEC SmartRelay is back in RUN mode:



You can press **◀** or **▶** to scroll the pages and to monitor the I/O states.

### 3.7.8 Deleting a block

Consider the case where you want to delete the block B2 from your circuit program and connect B1 directly to Q1.

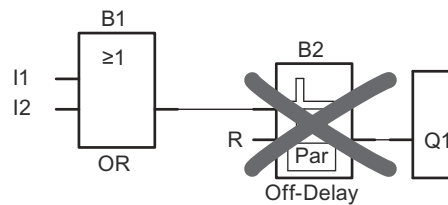

To delete this block, follow these steps:

1. Switch IDEC SmartRelay to programming mode.  
(As a reminder, refer to the topic "The four golden rules for operating IDEC SmartRelay (Page 57)").
2. Select " ① ": Press **▲** or **▼**.

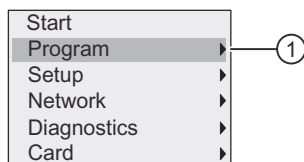

3. Confirm " ① ": Press **OK**.
4. Select " ② ": Press **▲** or **▼**.

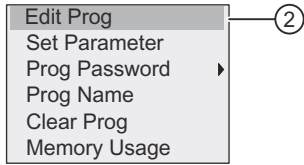

5. Confirm " ② ": Press **OK**.  
(If required, enter your password and confirm with **OK**.)
6. Press **OK** in the circuit program window, and the cursor now appears as a solid square.
7. Move the cursor to the Q1 block and then press **OK**.
8. Move the cursor to B2, the input of Q1, and confirm with **OK**.

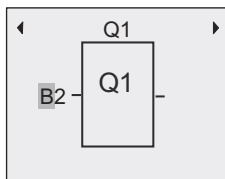

9. Now replace block B2 with block B1 at output Q1.
  - Move the cursor to the 2 in B2: Press **▶**.
  - Select 'B1': Press **▼**.
  - Apply 'B1': Press **OK**.

**Result:** IDEC SmartRelay deletes block B2 from the circuit and connects the output of B1 directly to output Q1.

### 3.7.9 Deleting block groups

Consider the case where you want to delete blocks B1 and B2 from the second circuit program example (refer to the "Second circuit program (Page 78)" topic).

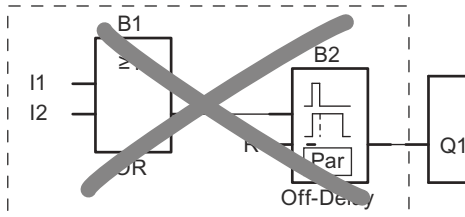

To delete these two blocks from that program, follow these steps:

1. Switch IDEC SmartRelay to programming mode.  
(As a reminder, refer to the topic "The four golden rules for operating IDEC SmartRelay (Page 57)").

2. To select " ① ": Press ▲ or ▼.

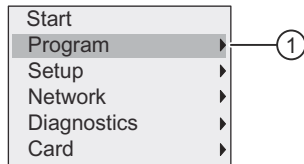

3. To confirm " ① ": Press **OK**.

4. To select " ② ": Press ▲ or ▼.

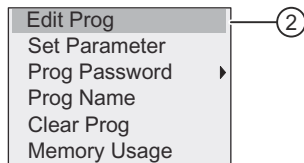

5. To confirm " ② ": Press **OK**.

(If required, enter your password and confirm with **OK**.)

6. Press **OK** in the circuit program window, and the cursor now appears as a solid square.
7. Move the cursor to the Q1 block and then press **OK**.
8. Move the cursor to B2, the input of Q1, and confirm with **OK**.

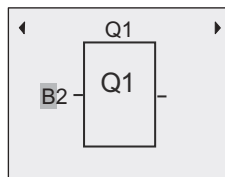

9. Now set the blank connector at output Q1 instead of block B2:

- Select the blank connector: Press ▲ or ▼.
- Apply the blank connector: Press **OK**.

**Result:** IDEC SmartRelay deletes block B2 and all blocks that connect to B2 (in this case, block B1) from the circuit.



### 3.7.10 Correcting programming errors

You can easily correct programming errors in IDEC SmartRelay. Providing that you are still in editing mode, you can revert one step by pressing **ESC**. If you have already configured all inputs, simply reconfigure the faulty input:

1. Move the cursor to the faulty position.
2. Change to editing mode: Press **OK**.
3. Enter the correct input circuit.

You can only replace a block with a block that has exactly the same number of inputs. However, you can delete the old block and then insert a new one. You can choose any new block.

### 3.7.11 Selecting analog output values for RUN/STOP transition

You can set the behavior of up to eight analog outputs when IDEC SmartRelay changes from RUN mode to STOP mode. To set the behavior for analog outputs for a RUN-to-STOP transition, follow these steps:

1. In the programming menu, move the cursor to " ① ": Press **▼** or **▲**.

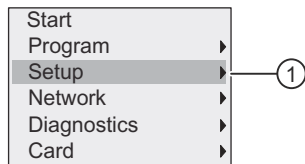

2. Select " ① ": Press **OK**.
3. Move the cursor to "AQ": Press **▼** or **▲**.
4. Select "AQ": Press **OK**.
5. Move the cursor to " ② ": Press **▼** or **▲**.

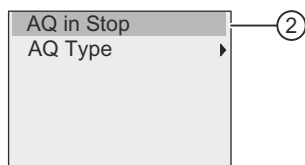

6. Select " ② ": Press **OK**.

IDEC SmartRelay shows the following display:

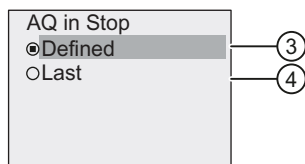

The circle with a dot before " ④ " above indicates the current setting for the analog output channels.

You can select either " ③ " or " ④ ". The default setting is " ④ " which means that IDEC SmartRelay holds the values of the analog outputs at their last values. A setting of " ③ " means that IDEC SmartRelay sets the analog output values to specific values, which you can configure. When IDEC SmartRelay changes from RUN mode to STOP mode, the values of the analog outputs change as well, depending on the setting.

7. Select the desired output setting: Press ▲ or ▼.
8. Confirm your entry: Press **OK**.

### Defining a specific analog output value

To output a specific analog value at the analog outputs, follow these steps:

1. Move the cursor to " ③ ": Press ▲ or ▼.

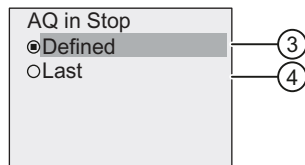

2. Confirm " ③ ": Press **OK**.

The display shows:

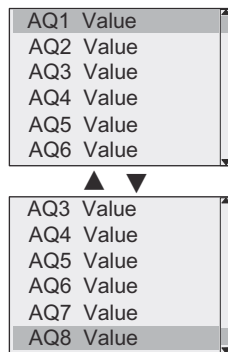

3. Select a desired analog output and press **OK**.
4. Enter a specific output value for the analog output.

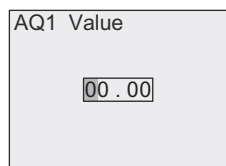

5. To confirm your entry, press **OK**.

### 3.7.12 Defining the type of analog outputs

Analog outputs can be either 0..10V/0..20mA, which is the default, or 4..20mA.

To define the type of analog outputs, follow these steps starting from the programming menu:

1. Move the cursor to " ① ": Press ▼ or ▲.

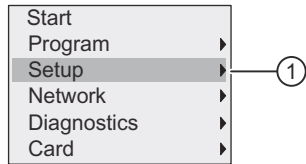

2. Select " ① ": Press OK.
3. Move the cursor to "AQ": Press ▼ or ▲.
4. Select "AQ": Press OK.
5. Move the cursor to " ② ": Press ▼ or ▲.

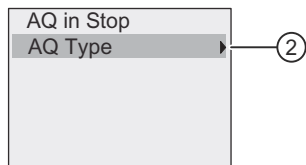

6. Select " ② ": Press OK.

IDEC SmartRelay shows the following display:

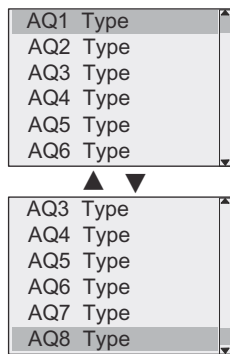

7. Move the cursor to the desired AQ, and press OK.

IDEC SmartRelay indicates the defined type for the analog channel by a circle with a dot.

8. Select either 0..10V/0..20mA (default) or 4..20mA: Press ▼ or ▲.
9. Confirm your selection: Press OK.

### 3.7.13 Setting the power-on delay of IDEC SmartRelay

You can set a power-on delay for IDEC SmartRelay in order to make sure all the connected expansion modules are powered on and ready to use before IDEC SmartRelay runs the circuit programs.

To set the power-on delay, follow these steps:

1. In the programming menu, move the cursor to " ① ": Press ▲ or ▼.

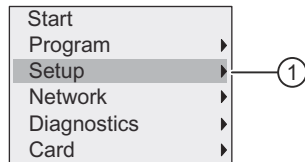

2. Confirm " ① ": Press **OK**.
3. Move the cursor to " ② ": Press ▲ or ▼.

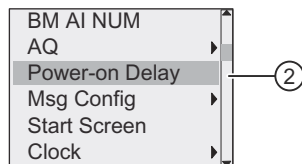

4. Confirm " ② ": Press **OK**. IDEC SmartRelay shows the following display:

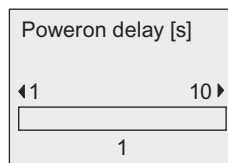

5. Press ► or ◀ to increase or decrease the delay time by 0.2 s. You can also press and hold down ► or ◀ to quickly increase or decrease the time.
6. Confirm your setting: Press **OK**.

### 3.7.14 Clearing the circuit program and password

To clear a circuit program and the password if one is defined, follow these steps:

1. Switch the IDEC SmartRelay to programming mode. IDEC SmartRelay opens the main menu:

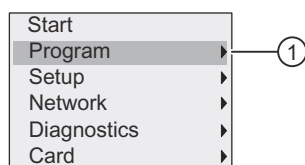

2. On the main menu, press ▲ or ▼ to move the cursor to " ① ". Press **OK**. IDEC SmartRelay opens the programming menu.
3. On the programming menu, move the cursor to " ② ": Press ▲ or ▼.

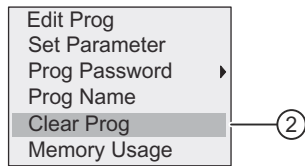

4. Confirm " ② ": Press **OK**.

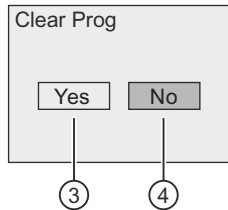

5. If you are sure that you want to clear the circuit program in the memory, move the cursor to " ③ " and confirm with **OK**. IDEC SmartRelay clears the circuit program and password.

To cancel clearing of the circuit program, leave the cursor at " ④ " and press **OK**.

### 3.7.15 Summertime/wintertime conversion

You can enable or disable automatic summertime/wintertime conversion.

---

#### Note

Summertime refers to "daylight saving time" and wintertime refers to "standard time" in the United States.

---

#### To enable/disable automatic S/W Time conversion in programming mode:

1. Switch IDEC SmartRelay to programming mode. IDEC SmartRelay displays the main menu.
2. Select " ① ": Press ▲ or ▼.

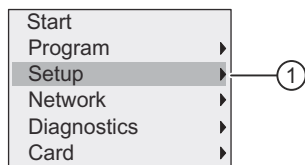

3. Confirm " ① ": Press **OK**.

4. Move the cursor to " ② ": Press ▲ or ▼.

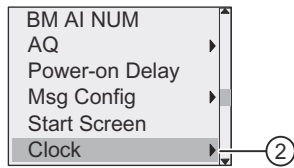

5. Confirm " ② ": Press **OK**.

6. Move the cursor to " ③ ": Press ▲ or ▼.

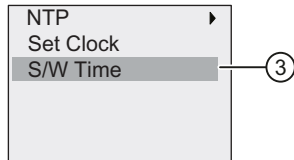

7. Confirm " ③ ": Press **OK**.

IDEC SmartRelay shows the following display:

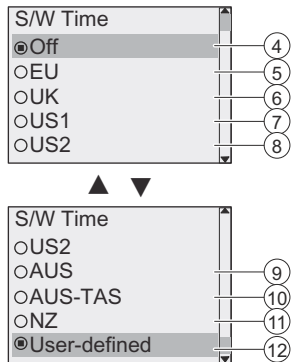

The current setting of automatic S/W Time conversion is indicated by a circle with a dot. The default setting is " ④ ": disabled.

What is shown on the display?:

- " ④ ": IDEC SmartRelay disables automatic S/W time conversion.
- " ⑤ " represents the start and end of European summertime.
- " ⑥ " represents the start and end of summertime in the United Kingdom.
- " ⑦ " represents the start and end of daylight saving time (summertime) in the United States prior to 2007.
- " ⑧ " represents the start and end of daylight saving time (summertime) in the United States in 2007 and later years.
- " ⑨ " represents the start and end of Australian summertime.
- " ⑩ " represents the start and end of Australian/Tasmanian summertime.
- " ⑪ " represents the start and end of New Zealand summertime.
- " ⑫ ": Here you can enter any month, day and time zone difference.

The table below lists the preset conversions:

Menu command	Start of summertime	End of summertime	Time zone difference $\Delta$
⑤	Last Sunday in March: 02:00 → 03:00	Last Sunday in October: 03:00 → 02:00	60 minutes
⑥	Last Sunday in March: 01:00 → 02:00	Last Sunday in October: 02:00 → 01:00	60 minutes
⑦	First Sunday in April: 02:00 → 03:00	Last Sunday in October: 02:00 → 01:00	60 minutes
⑧	Second Sunday in March: 02:00 → 03:00	First Sunday in November: 02:00 → 01:00	60 minutes
⑨	Last Sunday in October: 02:00 → 03:00	First Sunday in April: 03:00 → 02:00	60 minutes
⑩	First Sunday in October: 02:00 → 03:00	First Sunday in April: 03:00 → 02:00	60 minutes
⑪	Last Sunday in September: 02:00 → 03:00	First Sunday in April: 03:00 → 02:00	60 minutes
⑫	Customized month and day; 02:00 → 02:00 + Time zone difference	Customized month and day; Time zone difference: 03:00 → 03:00 - Time zone difference	User-defined (resolution in minutes)

8. To enable the summertime/winter time conversion and set parameters, press▲or ▼to select the desired conversion and then press **OK** to confirm.

**Note**

You can specify a time zone difference  $\Delta$  between 0 and 180 minutes.

**Enabling/disabling automatic S/W Time conversion in parameter assignment mode**

If you want to enable/disable automatic S/W Time conversion in parameter assignment mode, select " ① " in the parameter assignment menu, then menus " ② " and " ③ ". You can now enable/disable automatic S/W Time conversion.

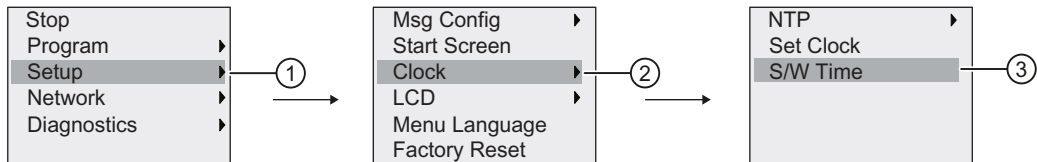

## User-defined parameters

If none of the parameters/conversions apply to your country, follow these steps to customize the settings:

1. Move the cursor to the menu item " ① ": Press ▲ or ▼.



2. Confirm with **OK**.

The display shows:

Cursor/flashing solid square

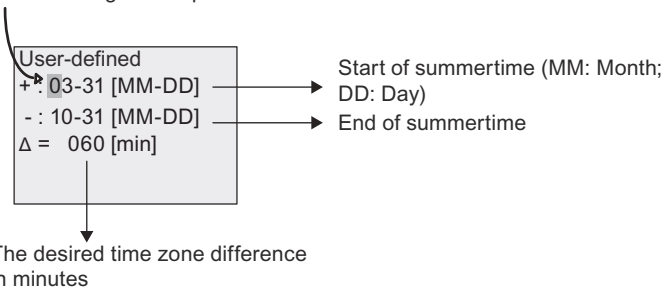

For example, consider an example where you want to configure the following parameters:

- Start of summertime = 31st March
- End of summertime = 1st November
- Time difference of 120 minutes

To configure these settings, follow these steps:

1. Press ◀ or ▶ to move the flashing solid square/cursor.
2. Press ▲ and ▼ to change the value at the cursor position.

The display shows:

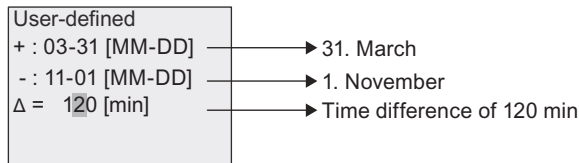

3. Confirm all your entries with **OK**.

You have now customized the summertime/wintertime conversion.

---

### Note

Summertime/wintertime conversion only functions when IDEC SmartRelay is operating in RUN or STOP mode. It does not function when the internal real-time clock of IDEC SmartRelay continues operation after a power failure (refer to Section "Backup of the real-time clock (Page 127)").

---



### 3.7.16 Network Time Protocol (FL1F FS5 and later versions only)

Network Time Protocol(NTP) function is a new feature and supported in FL1F FS5 and later versions BM. It is used for network time synchronization.

The NTP contains three function settings:

- NTP Client

NTP Client is used for configuring the NTP function, FL1F FS5 BM can both serve as an NTP Server and an NTP Client at the same time. To make IDEC SmartRelay BM synchronize time from the NTP Server, you need to set BM as NTP Client and configure its NTP Server IP first.

- NTP Server

NTP Server is only a reactor server. It can only provide the time passively while the broadcast function is disabled. FL1F FS5 can act as an NTP Server. When you enable it, FL1F FS5 works as a time provider for all standard NTP client, includes Windows/Linux NTP client, FL1F FS5 and so on.

- NTP Time Zone

NTP Client/Server can synchronize the time in different time zone, so we need to set NTP Time Zone in IDEC SmartRelay for reference. NTP Time Zone is used for setting the local time zone in BM/TDE and WindLGC. The default setting is GMT time zone.

The NTP function of IDEC SmartRelay BM is disabled by default. You can enable it in the BM/TDE menu or WindLGC.

#### Configuring NTP in programming mode

To configure NTP function, follow these steps:

1. Switch IDEC SmartRelay to programming mode. IDEC SmartRelay displays the main menu.

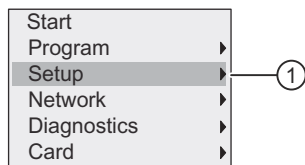

2. Select " ① ": Press ▲ or ▼.
3. Confirm " ① ": Press **OK**.
4. Move the cursor to " ② ": Press ▲ or ▼.

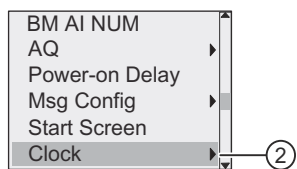

5. Confirm " ② ": Press **OK**.
6. Move the cursor to " ③ ": Press ▲ or ▼.

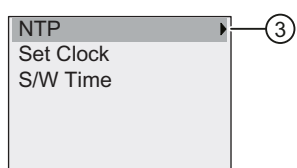

7. Apply " ③ ": Press **OK**.
8. Then there are three options for selecting:

- **NTP Time Zone**

NTP Client/Server can synchronize the time in different time zone, you can provide a time zone in FL1F FS5 for NTP functions.

The default setting is GMT time zone, and you can change it to the real local time zone in BM/TDE and WindLGC.

- **NTP Client**

To make IDEC SmartRelay BM synchronize time from the NTP server, you need to set BM as NTP client and configure its NTP server IP first. Any standard NTP server can be used for FL1F FS5, such as the Windows/Linux NTP Server, standard time provider and FL1F FS5 itself.

---

**Note**

For detailed information about security functions on IDEC SmartRelay, see Chapter Security (Page 281).

---

The NTP client is disabled by default, you can enable it in BM/TDE and WindLGC.

To enable NTP Client function, follow these steps:

- Move the cursor to " ④ ": Press **▲** or **▼**.

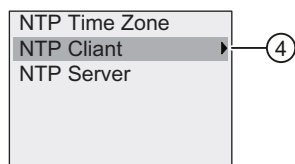

- Apply " ④ ": Press **OK**.
- IDEC SmartRelay shows the following display:

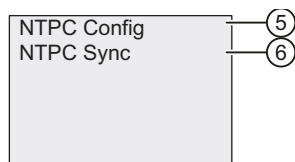

To enable NTP Client function, press **▲** or **▼** to select " ⑤ ";

To identify whether the synchronization request success or failure, press **▲** or **▼** to select " ⑥ ", and then confirm with **OK**. If the last synchronization is successful, the result panel in this menu item shows the last synchronize timestamp with a real time mode, otherwise a "not synchronized" is shown.

To enable NTP Client function, follow these steps:

---

**Note**

The NTP client can synchronize time from NTP server every 4096 seconds, but it can synchronize the time immediately in the following scenarios:

- Base Module Power on
  - Base Module from Stop to Run
  - Server IP is changed
  - Select " ⑥ "
-

- **NTP Server**

NTP server is only a reactor server. It can only provide the time passively while the broadcast function is disabled.

NTP server is disabled by default. You can enable it in BM/TDE or WindLGC.

FL1F FS5 can act as an NTP server. When you enable it, FL1F FS5 works as a time provider for all standard NTP client, includes Windows/Linux NTP client, FL1F FS5 and so on.

### Configuring NTP in parameter assignment mode

If you want to configure NTP function in parameter assignment mode, select " ① " in the parameter assignment menu , then menus " ② " , " ③ " and " ④ ". You can now enable NTP Client synchronization by selecting " ⑤ " .

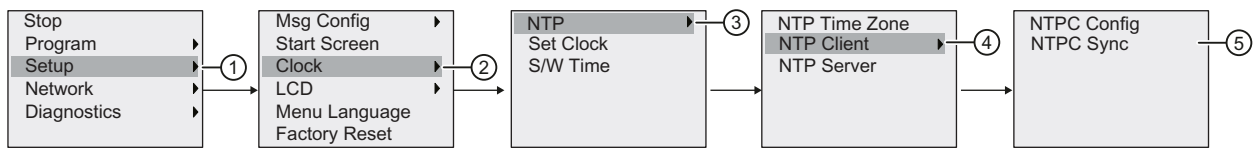

## 3.8 Configuring additional functions for IDEC SmartRelay

After you have successfully created the second circuit program, you can configure additional functions by means of the following menu commands:

- Network
- Diagnostics

### UDF and Data Log

You can configure the UDF and Data Log functions only from WindLGC. After you have configured them in WindLGC and downloaded them to the IDEC SmartRelay, you can then edit elements connected to these functions from the device:

- UDFs (User-Defined Functions)
- Data Log

### Network digital and analog I/O

You can configure the following connectors representing network digital or analog inputs/ outputs only from WindLGC:

- Network digital inputs
- Network analog inputs
- Network digital outputs
- Network analog outputs

---

#### Note

If your circuit program in an IDEC SmartRelay contains any network digital or analog inputs/ outputs, you can only edit the "Par" parameter of function blocks from IDEC SmartRelay. You can not edit any of the rest of the circuit program from the device.

---

### 3.8.1 Configuring network settings

An IDEC SmartRelay can establish network communication with other IDEC SmartRelay or a PC with WindLGC V8.0 or later version (For more detailed information, refer to the Maximum IDEC SmartRelay network setup (Page 15) topic). You can configure the IDEC SmartRelay network only from WindLGC V8.0 or later version. From IDEC SmartRelay, you can configure your IDEC SmartRelay's network settings including IP address, subnet mask and gateway.

#### Note

You can configure IDEC SmartRelay's network settings including IP address, subnet mask and gateway with the access level of administrator only. With the access level of operator, you can only view but cannot change the network settings.

For detailed information about Network security on IDEC SmartRelay, see Chapter Security (Page 281).

#### Configuring the network settings

IDEC SmartRelay provides a menu command for configuring network settings.

1. Switch IDEC SmartRelay to programming mode.
2. Press ▲ or ▼ to move the cursor to " ① ".

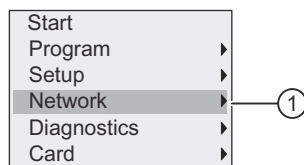

3. Press **OK** to confirm " ① ".
4. Press ▲ or ▼ to move the cursor to " ② ".

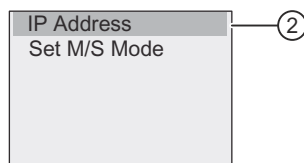

5. Press **OK** to confirm " ② ". IDEC SmartRelay displays the following view:

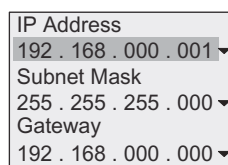

6. The display now shows the default IP address of your IDEC SmartRelay. To change the setting, press **OK**. When the cursor appears in a flashing solid square, press ◀ or ▶ to move the cursor to a position where you want to modify the number, then press ▲ or ▼ to increase or decrease the number. To confirm your change, press **OK**.

#### Note

The default IP address for FL1F: 192.168.000.001

The default IP address for Text Display: 192.168.000.002

The default IP address for FL1F FS5 and later version: 192.168.000.003

IDEC SmartRelay stores up to four addresses that you set previously. To view your last settings, press **▶** to move the cursor to the "▼" symbol, and then press **OK** to open a drop-down list, for example:

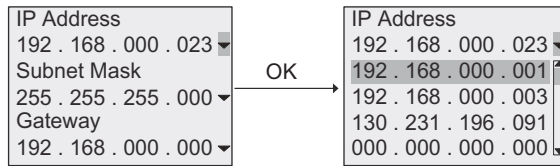

You can press **▲** or **▼** to select a previously configured address in the list, and then press **OK** to confirm.

7. Press **▲** or **▼** to move to the subnet mask setting. The default subnet mask is as shown above. To change the setting, press **OK**. When the cursor appears in a flashing solid square, press **◀** or **▶** to move the cursor to a position where you want to modify the number, then press **▲** or **▼** to increase or decrease the number. To confirm your change, press **OK**.
8. Press **▼** to move to the gateway address setting. The default gateway is as shown above. To change the setting, press **OK**. When the cursor appears in a flashing solid square, press **◀** or **▶** to move the cursor to a position where you want to modify the number, then press **▲** or **▼** to increase or decrease the number. To confirm your change, press **OK**.

### Transferring the circuit program to WindLGC

After you have finished the network settings, you can transfer the circuit program from IDEC SmartRelay to WindLGC using the transfer command IDEC SmartRelay → PC in WindLGC. For further information on uploading the circuit program to WindLGC with this transfer menu command, refer to the Online Help for WindLGC.

### 3.8.2 Configuring a UDF (User-Defined Function)

You can configure UDF (User-Defined Function) blocks only from WindLGC.

A UDF block is a preconfigured circuit program that you create in WindLGC. You can add it to an existing circuit program as you do with a function block. For a detailed description of the UDF configuration in WindLGC, refer to the Online Help for WindLGC.

If your circuit program in IDEC SmartRelay contains a UDF block, you can configure elements connected to the block. For more information of configuration of UDF elements from IDEC SmartRelay, refer to the topic UDF (User-Defined Function) (Page 253).

### 3.8.3 Configuring the Data Log

You can configure the Data Log block only from WindLGC.

You can configure a maximum of one Data Log for your circuit program using WindLGC. The Data Log is used to record process measurement variables of the selected function blocks. For a detailed description of configuration of the Data Log function in WindLGC, refer to the Online Help for WindLGC.

If your circuit program in IDEC SmartRelay contains the Data Log block, you can configure elements connected to the block. For more information of configuration of Data Log elements from IDEC SmartRelay, refer to the topic Data log (Page 257).

### 3.8.4 Viewing network inputs/outputs

WindLGC provides you with the following connectors representing network input/output blocks:

- Network digital inputs (identified with an **NI** in IDEC SmartRelay)
- Network analog inputs (identified with an **NAI** in IDEC SmartRelay)
- Network digital outputs (identified with an **NQ** in IDEC SmartRelay)
- Network analog outputs (identified with an **NAQ** in IDEC SmartRelay)

Network digital or analog inputs can connect with the inputs of function blocks. Network digital or analog outputs can connect with the outputs of function blocks.

If your circuit program contains a network digital/analog input, IDEC SmartRelay can read a digital/analog value from another circuit program in a networked device. If your circuit program contains a network digital/analog output, IDEC SmartRelay can write its digital/analog output value to another networked IDEC SmartRelay in slave mode.

---

#### Note

You can only configure these network connectors for your circuit program from WindLGC. If your circuit program in IDEC SmartRelay contains a network connector, you can not make any edits to the circuit program from the IDEC SmartRelay onboard display.

---

### Viewing network connectors in IDEC SmartRelay

Consider a circuit program where a network digital input NI1 connects to the function block B5. B5 is connected to Q4. To view this network input, follow these steps:

1. Switch IDEC SmartRelay to programming mode.
2. Select " ① ": Press ▲ or ▼.

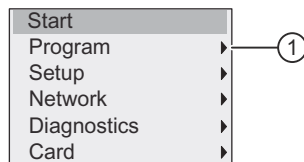

3. Confirm " ① ": Press **OK**.
4. Select " ② ": Press ▲ or ▼.

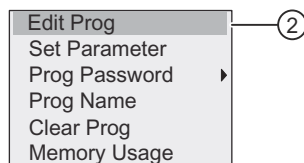

5. Confirm " ② ": Press **OK**.  
(If required, enter your password and confirm with **OK**.)
6. Press **OK** in the circuit program window, and the cursor now appears as a solid square.

7. Move the cursor to the B5 block and then press **OK**. IDEC SmartRelay shows the following display:

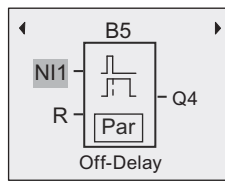

You can see that there is a network digital input NI1 connected at the first input of B5.

The following views are examples of network digital and analog outputs in IDEC SmartRelay:

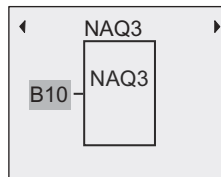
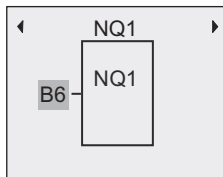

### Available network input/output blocks in WindLGC

The following network I/O blocks are available for you to create your circuit program in WindLGC:

- Network digital inputs: NI1 to NI64
- Network analog inputs: NAI1 to NAI32
- Network digital outputs: NQ1 to NQ64
- Network analog outputs: NAQ1 to NAQ16

### 3.8.5 Changing IDEC SmartRelay to master/slave mode

IEDEC SmartRelay provides a menu command for network communication settings. This section shows you how to change IDEC SmartRelay's network communication mode.

An IDEC SmartRelay works in either **master** or **slave** communication mode.

#### Master mode versus slave mode

An IDEC SmartRelay in master mode supports client-server communication with other FL1F devices across Ethernet. This IDEC SmartRelay can additionally act as a master to communicate with one or more FL1F devices in slave mode.

An IDEC SmartRelay in slave mode functions as an expansion module. IDEC SmartRelay slave devices do not require a circuit program. A master IDEC SmartRelay can read one or more slave IDEC SmartRelay's digital/analog input/output values and write its own digital/analog output values to these slaves. This helps IDEC SmartRelay achieve network I/O expansion.

---

#### Note

An IDEC SmartRelay in slave mode can also have its own expansion modules. It also supports a maximum of 24 digital inputs, 8 analog inputs, 20 digital outputs and 8 analog outputs.

---

## Changing IDEC SmartRelay from master mode to slave mode

1. In the main menu in programming mode, move the cursor to " ① ": Press ▲ or ▼.

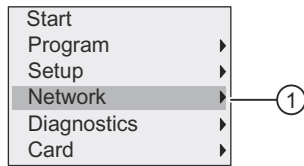

2. Confirm " ① ": Press **OK**.
3. Move the cursor to " ② ": Press ▲ or ▼.

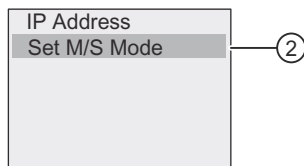

4. Confirm " ② ": Press **OK**.
5. Move the cursor to " ③ ": Press ▲ or ▼.

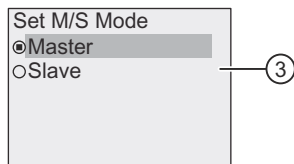

6. Confirm " ③ ": Press **OK**.

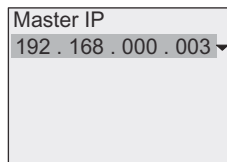

7. In this view, you enter the IP address of the IDEC SmartRelay that you want to configure to be the master of your slave IDEC SmartRelay. To change the setting, press **OK**. When the cursor appears in a flashing solid square, press ◀ or ▶ to move the cursor through the numbers. Press ▲ or ▼ to change the number.
8. Confirm the setting: Press **OK**

You have now successfully changed IDEC SmartRelay from master mode to slave mode. IDEC SmartRelay restarts automatically and then displays the main menu. Stepping into the following view, you can see that your IDEC SmartRelay is now in slave mode:

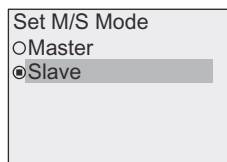

### Note

When IDEC SmartRelay is in slave mode, you can not edit the circuit program from the slave IDEC SmartRelay.

You cannot change IDEC SmartRelay to master/slave mode in parameter assignment mode.



### Changing IDEC SmartRelay from slave mode to master mode

IDEC SmartRelay is now in slave mode:

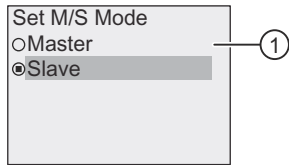

1. Move the cursor to " ① ": Press ▲ or ▼.
2. Confirm " ① ": Press **OK**.

You have now successfully changed IDEC SmartRelay from slave mode to master mode. IDEC SmartRelay restarts automatically and then displays the main menu.

Alternatively, you can change IDEC SmartRelay from slave mode to master mode from WindLGC. If you download a circuit program to an IDEC SmartRelay in slave mode from WindLGC, you are prompted to switch IDEC SmartRelay to master mode to complete the downloading. For more information, refer to the Online Help for WindLGC.

### 3.8.6 Diagnosing errors from IDEC SmartRelay

IDEC SmartRelay supports error event diagnostics. You can perform the following actions from IDEC SmartRelay's diagnostics menu:

- View software status and errors:
  - Data connection error
  - Firmware version of IDEC SmartRelay
- View hardware status and errors:
  - Ethernet connection error
  - Micro SD card error (for example, card read/write error, card is not inserted, or card is full)
  - EM (expansion module) status and error (for example, bus error and configuration update)
  - MAC address of IDEC SmartRelay
- View and clear the event log, and check the availability of a specific IP address
- Toggle an error event alert

## Viewing the software status and errors of IDEC SmartRelay

To view the software status and errors, follow these steps:

1. In the main menu, move the cursor to " ① ": Press ▲ or ▼.

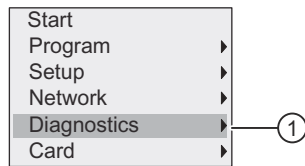

2. Confirm " ① ": Press **OK**.

3. IDEC SmartRelay shows you the diagnostics menu. Move the cursor to " ② ": Press ▲ or ▼.

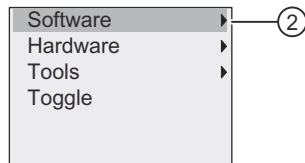

4. Confirm " ② ": Press **OK**. IDEC SmartRelay shows you the following display:

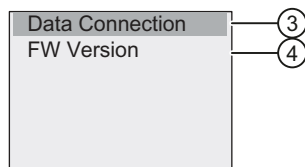

5. You can select " ③ " to view the real-time status of the FL1F connection or Modbus connection. Select " ④ " to view the firmware version of IDEC SmartRelay.

After you select " ③ ", you can press ◀ or ▶ to view the status of each Data connection.

## Viewing the hardware status and errors of IDEC SmartRelay

To view the hardware status and errors, follow these steps:

1. In the main menu, move the cursor to " ① ": Press ▲ or ▼.

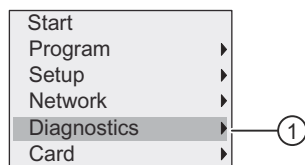

2. Confirm " ① ": Press **OK**.

3. IDEC SmartRelay shows you the diagnostics menu. Move the cursor to " ② ": Press ▲ or ▼.

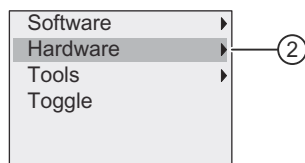

4. Confirm " ② ": Press **OK**. IDEC SmartRelay shows you the following display:

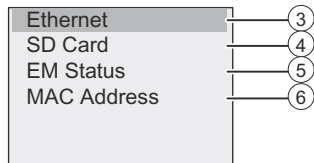

5. You can select the following menu commands to view the corresponding hardware status and errors:

- ③ : To view the status of the Ethernet interface of IDEC SmartRelay. If the Ethernet cable is not connected, an error appears.
- ④ : To view the status of the micro SD card. You may find an error event under this menu command when no card is inserted, the card is full, or a read/write error occurs.
- ⑤ : To view the real-time status of the connected expansion module(s). You can find the number of the expansion modules and the total I/O number under this menu command.
- ⑥ : To view the MAC address of IDEC SmartRelay

### Viewing error information

To view the errors detected, follow these steps:

1. In the diagnostics menu shown below, move the cursor to " ① ": Press **▲** or **▼**.

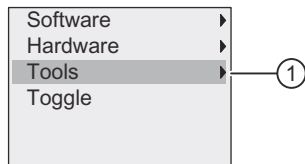

2. Confirm " ① ": Press **OK**.

3. Move the cursor to " ② ": Press **▲** or **▼**.

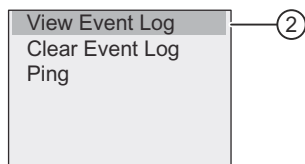

4. Confirm " ② ": Press **OK**. IDEC SmartRelay displays all errors detected. You can press **◀** or **▶** to view each error record. Press **ESC** or **OK** to return to the previous menus.

## Clearing error information

To clear all errors, follow these steps:

1. In the diagnostics menu shown below, move the cursor to " ① ": Press ▲ or ▼.

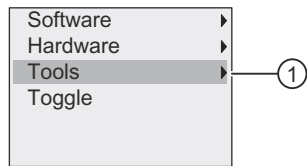

2. Confirm " ① ": Press **OK**.
3. Move the cursor to " ② ": Press ▲ or ▼.

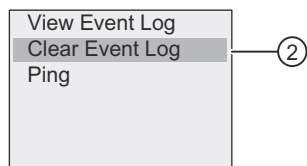

4. Confirm " ② ": Press **OK**.
5. Move the cursor to " ③ ": Press ▲ or ▼.

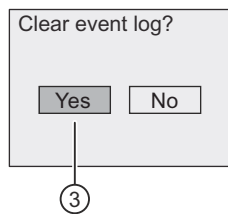

6. Confirm " ③ ": Press **OK**. IDEC SmartRelay clears all error messages and displays as follows:

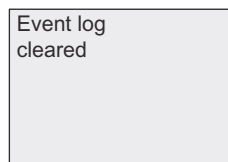

### Diagnosing a specific IP address

You can check the availability of a specific IP address by following these steps:

1. In the diagnostics menu shown below, move the cursor to " ① ": Press ▲ or ▼.

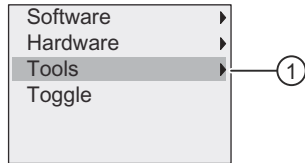

2. Confirm " ① ": Press **OK**.
3. Move the cursor to " ② ": Press ▲ or ▼.

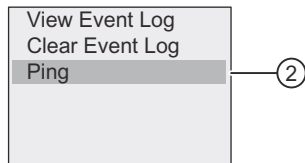

4. Confirm " ② ": Press **OK**. IDEC SmartRelay displays the following view:

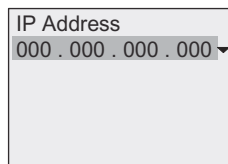

5. To enter an IP address, Press **OK**. When the cursor appears in a flashing solid square, press ◀ or ▶ to move the cursor to a position where you want to modify the number, then press ▲ or ▼ to increase or decrease the number.
6. Press **OK** to confirm your input.

When pinging the IP address is successful and the IP address is available, OK message is displayed. If timeout occurs and the IP address is unavailable, an error message is displayed.

IDEC SmartRelay stores up to four addresses that you entered previously. To view your last inputs, press ▶ to move the cursor to the "▼" symbol, and then press **OK** to open a drop-down list, for example:

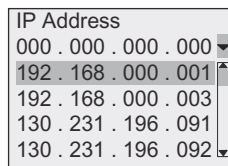

You can press ▲ or ▼ to select a previously configured address in the list, and then press **OK** to confirm.

## Toggleing an error alert

You can enable/disable an error alert by following these steps:

1. In the diagnostic menu shown below, move the cursor to " ① ": Press ▲ or ▼.

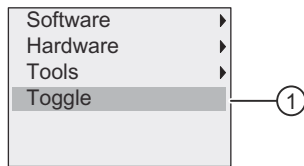

2. Confirm " ① ": Press **OK**.
3. The circle with a dot indicates the current setting. To change the setting: Press ▲ or ▼.

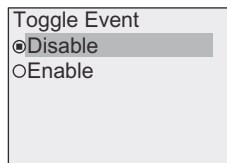

4. Confirm your selection: Press **OK**. IDEC SmartRelay returns to the previous view.

If you enable the error alert, when an error occurs, the IDEC SmartRelay display turns to red backlight, reminding you that IDEC SmartRelay detects an error. You can go to the diagnostics menu to view and clear the error.

## 3.9 Memory space and circuit program size

The size of a circuit program in IDEC SmartRelay is limited by the memory space.

### Memory areas

- **Program memory:**  
IDEC SmartRelay allows only a limited number of blocks in your circuit program. The second limitation is based on the maximum number of bytes a circuit program can contain. You can determine the total number of bytes used by adding up the number of bytes used for the relevant function blocks.
- **Retentive memory (Rem):**  
In this area, IDEC SmartRelay stores values that are retentive; for example, the operating hours counter value. Blocks with optional retentivity use this memory area only if you have enabled the retentivity function.

**CAUTION**

At a power failure, the logical input level may drop to zero before IDEC SmartRelay can save the functions to the retentive memory. In this case, the IDEC SmartRelay saves the function values determined by the zero state at its inputs of the inputs.

**Example: On-delay**

With an input (I1) connected to a Trg connector of an On-delay FB as shown in Fig.1, if I1 is ON and the IDEC SmartRelay power is turned off and on, the timer current value of the On-delay FB is sometimes reset as shown in Fig.2.

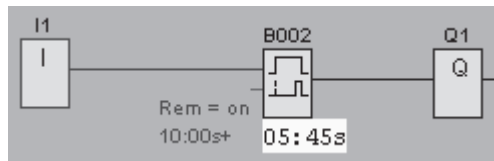

Fig. 1

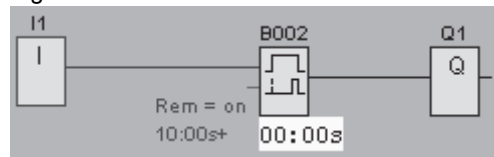

Fig. 2

Other FBs are shown below.

- Function blocks whose timer current value is sometimes reset. Off-delay, On-delay, On-/Off-delay, Retentive on-delay, Interval time-delay relay/Pulse output, Edge-triggered interval time-delay relay, Operating hours counter, Asynchronous pulse generator, Stairwell Light Switch, Dual-function switch, Stopwatch
- Function blocks whose output is sometimes set or reset when input (I\*) is connected to a S(R) connector with NOT. Latching relay, Current impulse relay

## Resources available in IDEC SmartRelay

A circuit program in IDEC SmartRelay can occupy the following maximum resources:

IDEC SmartRelay device series	Bytes	Blocks	REM
IDEC SmartRelay	8500	400	250

IDEC SmartRelay monitors memory utilization, and offers only those functions from the lists for which it can actually provide sufficient memory space.

## Memory requirements

The table below shows an overview of the memory requirements for the basic and special function blocks in IDEC SmartRelay FL1F:

Function	Program memory	REM memory*
<b>Basic functions</b>		
AND	12	-
AND with edge detection	12	-
NAND (not AND)	12	-
NAND with edge detection	12	-
OR	12	-
NOR (not OR)	12	-
XOR (exclusive OR)	8	-
NOT (Negation)	8	-
<b>Special functions</b>		
Timers		
On-delay	12	3
Off-delay	16	3
On-/Off-delay	16	3
Retentive on-delay	16	3
Interval time-delay relay/Pulse output	12	3
Edge-triggered interval time-delay relay	20	4
Asynchronous pulse generator	16	3
Random generator	16	-
Stairwell light switch	16	3
Dual-function switch	20	3
Seven-day time switch	24	-
Twelve-month time switch	12	-
Astronomical clock	40	-
Stopwatch	28	19
Counters		
Up/down counter	32	5
Operating hours counter	36	13
Frequency trigger	20	-
Analog		
Analog trigger	20	-



Function	Program memory	REM memory*
Analog differential trigger	20	-
Analog comparator	24	-
Analog watchdog	24	-
Analog amplifier	12	-
Pulse Width Modulator (PWM)	32	-
Analog math	24	-
Analog math error detection	16	1
Analog multiplexer	20	-
Analog ramp control	40	-
PI controller	44	2
Analog filter	20	-
Max/Min	20	7
Average value	32	20
Others		
Latching relay	12	1
Current impulse relay	12	1
Message texts	12	-
Softkey	12	2
Shift register	16	1
Float/Integer Converter	20	-
Integer/Float Converter	24	-

\*: Bytes in the REM memory area if you have enabled retentivity

**Note**

Since a UDF block is a preconfigured circuit program that you create from WindLGC for your IDEC SmartRelay device, the memory size (program memory and REM memory) of a UDF block depends upon the size of the function blocks contained in the UDF.

**Utilization of memory areas**

IDEC SmartRelay indicates that there is insufficient memory space by not allowing you to add a block to your circuit program. IDEC SmartRelay offers you only the blocks for which it can provide sufficient memory space. If IDEC SmartRelay memory space is insufficient to hold any additional blocks, the system denies access to the block list.

If memory space is full, optimize your circuit program or install another IDEC SmartRelay.

### Calculating memory requirements

When calculating the memory requirements of a circuit, you must always take into account all individual areas of memory.

**Example:**

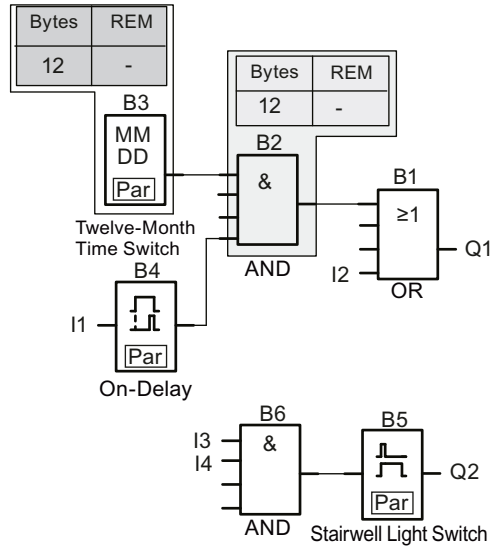

The sample circuit program contains:

Block no.	Function	Memory area		
		Bytes	Blocks	REM
B1	OR	12	1	-
B2	AND	12	1	-
B3	Twelve-month time switch	12	1	-
B4	On-delay*	12	1	3
B5	Stairwell light switch	16	1	3
B6	AND	12	1	-
	Resources used by the circuit program	76	6	6
	Memory space limits in IDEC SmartRelay	8500	400	250
	<b>Still available in IDEC SmartRelay</b>	<b>8424</b>	<b>394</b>	<b>244</b>

\*: Configured with retentivity.

This means that this circuit program fits in IDEC SmartRelay.

### Indication of available memory space

To view the amount of free memory space in IDEC SmartRelay, follow these steps:

1. Switch IDEC SmartRelay to programming mode.  
(As a reminder, refer to the topic "The four golden rules for operating IDEC SmartRelay (Page 57)".)
2. Move the cursor to " ① ": Press ▲ or ▼.

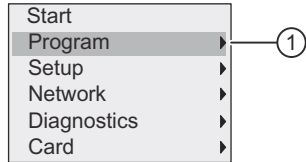

3. Confirm " ① ": Press **OK**.
4. Move the cursor to " ② ": Press ▲ or ▼.

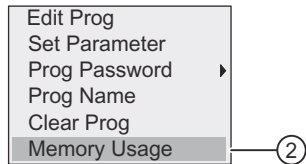

5. Confirm " ② ": Press **OK**.

The display now shows:

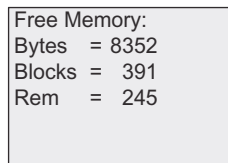

## IDEC SmartRelay functions

IDEC SmartRelay provides you with various elements in programming mode, and organizes them in the following lists:

- Constants and connectors (Page 113)
- Basic functions list - GF (Page 118)
- Special functions list - SF (Page 129)
- List of reusable blocks configured in the circuit program

IDEC SmartRelay FL1F can additionally provide you with the following elements in programming mode, if you have previously configured them in your circuit program using WindLGC:

- UDF: List of user-defined function blocks configured in the circuit program
- L: A Data Log function block configured in the circuit program

### List contents

All lists show the elements available in IDEC SmartRelay. Usually, this includes all connectors, basic functions, and special functions.

IDEC SmartRelay does not show all elements if:

- You cannot add additional blocks.  
This occurs when the memory space is insufficient or when you have reached the maximum number of blocks.
- A specific block's Memory space and circuit program size (Page 107) would exceed the space available in IDEC SmartRelay.
- You have created program elements in WindLGC but have not downloaded the program to IDEC SmartRelay.

## 4.1 Constants and connectors

Constants and connectors represent inputs, outputs, markers, constants, and network digital and analog inputs/outputs.

### Inputs

- **Digital inputs**

Digital inputs begin with the letter **I**. The number of the digital inputs (I1, I2, ...) corresponds to the number of the input connectors of the IDEC SmartRelay Base Module and of the connected digital modules, in the order of their installation. You can use the fast digital inputs I3, I4, I5, and I6 of the IDEC SmartRelay versions FL1F-H12RCE, FL1F-B12RCE, and FL1F-H12SCD as fast counters.

**Note**

To avoid that the IDEC SmartRelay Base Module fails to read input signals because its built-in MCU (Microcontroller Unit) is too sensitive and runs much faster than those in previous IDEC SmartRelay devices, an on-/off-delay function is designed for IDEC SmartRelay:

- For FL1F-H12RCC and FL1F-B12RCC, a 25 ms on-delay time and a 20 ms off-delay time are defined for digital inputs I1 to I8.
- For all the other IDEC SmartRelay versions, a 5 ms on-delay time and a 5 ms off-delay time are defined for all the digital inputs.

Besides, when the Base Module is in slave mode, a 5 ms on-delay time and a 100 ms signal-retentive-time are defined for all the digital inputs.

- **Analog inputs**

The IDEC SmartRelay versions FL1F-H12SCD, FL1F-H12RCE and FL1F-B12RCE have the inputs I1, I2, I7 and I8, which you can also program for use as **AI3, AI4, AI1** and **AI2** inputs. As described in topic "Setting the number of AIs in IDEC SmartRelay (Page 270)", you can configure these modules to use either two analog inputs (AI1 and AI2), or all four. IDEC SmartRelay interprets signals at the I1, I2, I7 and I8 inputs as digital values, and those at the AI3, AI4, AI1 and AI2 inputs as analog values. Note that AI3 corresponds to I1 and AI4 corresponds to I2. This numbering preserves the previous correspondence of AI1 to I7 and AI2 to I8 that was available with the FL1D series. IDEC SmartRelay numbers the inputs of a connected analog module according to the already existing analog inputs. See topic "Maximum setup with expansion modules (Page 17)" for example setups. In programming mode, when you select the input signal of a special function that takes an analog input, IDEC SmartRelay offers the analog inputs AI1 to AI8, analog memory markers AM1 to AM64, analog outputs AQ1 to AQ8, and the block numbers of functions with analog outputs.

**Outputs**

- **Digital outputs**

Digital outputs begin with the letter **Q**. The output numbers (Q1, Q2, ... Q20) correspond with the numbers of the output connectors at the IDEC SmartRelay Base Module and with those of the expansion modules, in their order of installation.

IDEC SmartRelay FL1F also provides 64 blank outputs and identifies them with the letter **x**. You cannot reuse the blank outputs in a circuit program. The blank outputs differ from memory markers, for example, which you can reuse. A blank output, for example, is useful for the special function Message texts (Page 197), if only the message text is of significance to a circuit program.

- **Analog outputs**

Analog outputs begin with the letters **AQ**. Eight analog outputs are available, namely AQ1, AQ2,... AQ8. You can only connect an analog output with the analog input of a function, an analog memory marker AM or an analog output connector.

The following figure shows an example IDEC SmartRelay configuration and the numbering of the inputs and outputs for the circuit program.

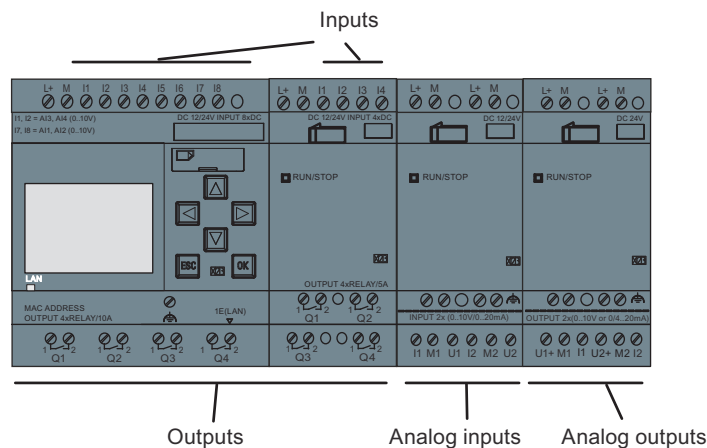

**Note**

IEDEC SmartRelay supports the graphical display of the analog value changes in the form of a trend curve on the onboard display. You can easily monitor each analog I/O in use by means of the trend curves when IDEC SmartRelay is in RUN mode. For more information on how to view the trend curve, refer to "Switching IDEC SmartRelay to RUN mode (Page 74)".

**Memory markers**

The letters **M** or **AM** identify memory markers blocks. These are virtual outputs, which output the value of their inputs. IDEC SmartRelay provides 64 digital memory markers M1 to M64 and 64 analog memory markers AM1 to AM64.

**Startup marker M8**

IEDEC SmartRelay sets marker M8 in the first cycle of the circuit program. You can thus use it as a startup marker in your circuit program. IDEC SmartRelay resets M8 at the end of the first cycle.

You can use the M8 marker in all further cycles for setting, deletion and evaluation procedures in the same way as other markers.

**Backlight markers M25, M26, M28 to M31**

The following markers control the backlight colors of the IDEC SmartRelay onboard display or the FL1F-RD1:

Backlight display	Marker	Remarks
White	M25	The color white means IDEC SmartRelay is in RUN mode.
	M26	The color white means FL1F-RD1 is in RUN mode.

Amber	M28	The color amber means IDEC SmartRelay is in programming mode or parameter assignment mode.
	M30	The color amber means Text Display is in programming mode, parameter assignment mode or TDE setting mode.
Red	M29	The color red means IDEC SmartRelay has a diagnosis error.
	M31	The color red means Text Display has a diagnostics error.

**Note:** The backlight lifetime of the Text Display is 20,000 hours.

### Message text character set marker M27

The M27 marker selects between the two character sets that IDEC SmartRelay uses to display message texts. State 0 corresponds to Character Set 1, and state 1 corresponds to Character Set 2. If M27=0 (low), IDEC SmartRelay only displays message texts configured for Character Set 1; If M27=1 (high), IDEC SmartRelay only displays message texts configured for Character Set 2. If you do not include M27 in the circuit program, message texts display in the character set that you selected from either WindLGC or an IDEC SmartRelay device.

---

**Note**

- The output of the marker always carries the signal of the previous program cycle. This value does not change within the same program cycle.
  - You can read or write markers from the network. If you have not added any special markers in the diagram, but written them from the network, they can still work except M27. So if you want to control character sets by M27, you must add it in the diagram first, and you can connect M27 to NI blocks to control it from the network.
- 

### Shift register bits

IDEC SmartRelay provides read-only shift register bits S1.1 to S4.8. Only the Shift register (Page 208) special function can modify shift register bit values.

### Cursor keys

Up to four cursor keys are available to you, namely C ▲, C ►, C ▼ and C ◀ ("C" = "Cursor"). Cursor keys are programmed for the circuit program in the same way as other inputs. You can program cursor keys in the corresponding display Switching IDEC SmartRelay to RUN mode (Page 74) , and in an active message text (ESC + Key). Cursor keys can save switches and inputs, and allow operator control of the circuit program. Cursor key inputs from the FL1F-RD1 are identical to cursor key inputs from the Base Module.

## FL1F-RD1 function keys

The FL1F-RD1 has four function keys, F1, F2, F3, and F4, which you can use in your circuit program. You program these keys in the same way as other inputs. Like the cursor keys, you can press these keys when IDEC SmartRelay is in RUN mode to affect the behavior of the circuit program, and to save switches and inputs.

## Levels

Voltage levels are designated **hi** and **lo**. A constant "1" = hi or "0" = lo status at the block can be set by means of a permanent voltage level or constant value hi or lo.

## Open connectors

IDEC SmartRelay uses the letter **x** to indicate unused block connectors.

## Network inputs/outputs (available only if configured from WindLGC)

You can configure the following network inputs/outputs only from WindLGC. If the circuit program in IDEC SmartRelay contains a network digital/analog I/O, you can not edit any of the rest of the circuit program except for the Par parameter. To edit the rest of the program, you must upload the program to WindLGC and then edit from WindLGC.

### 1) Network digital inputs

The letters **NI** identify a network digital input. There are 64 digital network digital inputs NI1 to NI64 available for configuration in the circuit program from WindLGC.

### 2) Network analog inputs

The letters **NAI** identify a network analog input. There are 32 network analog inputs NAI1 to NAI32 available for configuration in the circuit program from WindLGC.

### 3) Network digital outputs

The letters **NQ** identify a network digital output . There are 64 network digital outputs NQ1 to NQ64 available for configuration in the circuit program from WindLGC.

### 4) Network analog outputs

The letters **NAQ** identify a network analog output. There are 16 network analog outputs NAQ1 to NAQ16 available for configuration in the circuit program from WindLGC.



## 4.2 Basic functions list - GF

Basic functions represent simple logical elements of Boolean algebra.

You can invert the inputs of individual basic functions, that is, the circuit program inverts a logical "1" at a relevant input to a logical "0"; if "0" is the value at the input, the program sets a logical "1". See the programming example at Circuit program input (Page 65).

The GF list contains the basic function blocks you can use for your circuit program. The following basic functions are available:

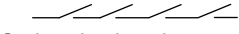
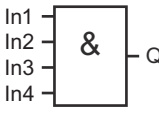
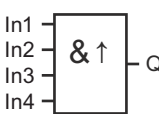
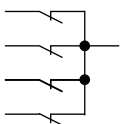
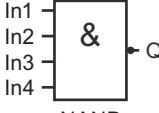
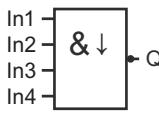
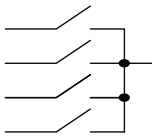
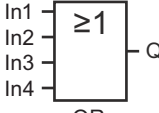
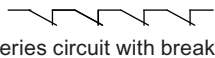
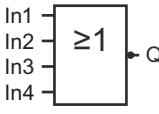
View in the circuit diagram	View in IDEC SmartRelay	Name of the basic function
 <p>Series circuit make contact</p>	 <p>AND</p>	AND (Page 119)
	 <p>AND (Edge)</p>	AND with edge detection (Page 120)
 <p>Parallel circuit with break contacts</p>	 <p>NAND</p>	NAND (not AND) (Page 120) (not AND)
	 <p>NAND (Edge)</p>	NAND with edge detection (Page 121)
 <p>Parallel circuit with make contacts</p>	 <p>OR</p>	OR (Page 122)
 <p>Series circuit with break contacts</p>	 <p>NOR</p>	NOR (not OR) (Page 123) (not OR)

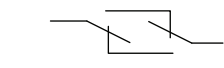
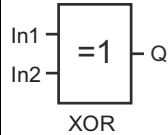
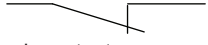
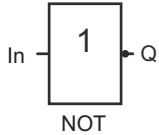
View in the circuit diagram	View in IEEC SmartRelay	Name of the basic function
 Double changeover contact	 XOR	XOR (exclusive OR) (Page 124) (exclusive OR)
 Break contact	 NOT	NOT (Negation, Inverter) (Page 124) (negation, inverter)

### 4.2.1 AND

Circuit diagram of a series circuit with several make contacts:

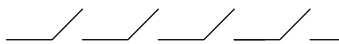

Symbol in IEEC SmartRelay:

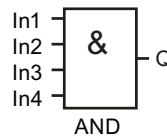

The output of the AND is only 1 if **all** inputs are 1, that is, all contacts are closed.

At an unused block input (x): x = 1.

#### AND function logic table

1	2	3	4	Q
0	0	0	0	0
0	0	0	1	0
0	0	1	0	0
0	0	1	1	0
0	1	0	0	0
0	1	0	1	0
0	1	1	0	0
0	1	1	1	0
1	0	0	0	0
1	0	0	1	0
1	0	1	0	0
1	0	1	1	0
1	1	0	0	0
1	1	0	1	0
1	1	1	0	0
1	1	1	1	1

### 4.2.2 AND with edge detection

Symbol in IDEC SmartRelay:

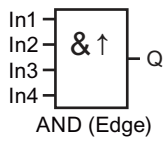

The output of an edge-triggered AND is only 1 if **all** inputs are 1 and if **at least one** input was low in the previous cycle.

At an unused block input (x): x = 1.

#### Timing diagram for the AND with edge detection

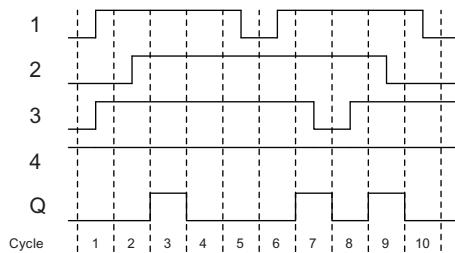

### 4.2.3 NAND (not AND)

Parallel circuit with multiple break contacts in the circuit diagram:

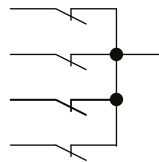

Symbol in IDEC SmartRelay:

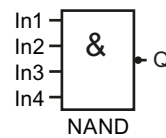

The output of the NAND is only 0 if the status at **all** inputs is 1, that is, the contacts are closed.

At an unused block input (x): x = 1.

#### NAND function logic table

1	2	3	4	Q
0	0	0	0	1
0	0	0	1	1
0	0	1	0	1
0	0	1	1	1
0	1	0	0	1
0	1	0	1	1
0	1	1	0	1
0	1	1	1	1
1	0	0	0	1
1	0	0	1	1

1	2	3	4	Q
1	0	1	0	1
1	0	1	1	1
1	1	0	0	1
1	1	0	1	1
1	1	1	0	1
1	1	1	1	0

#### 4.2.4 NAND with edge detection

Symbol in IDEC SmartRelay:

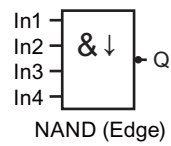

The output status of the NAND with edge detection is only 1 if **at least one** input is 0 and if **all** inputs were 1 in the previous cycle.

At an unused block input (x): x = 1.

#### Timing diagram for the NAND with edge detection

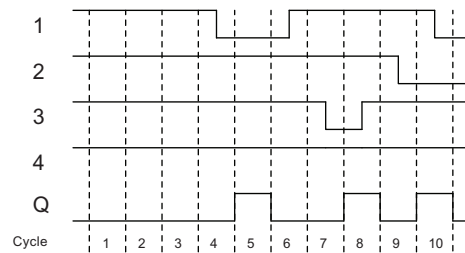

### 4.2.5 OR

Circuit diagram of a parallel circuit with several make contacts:

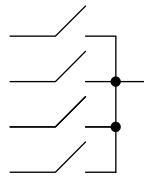

Symbol in IDEC SmartRelay:

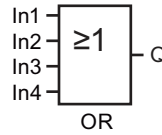

The output status of the OR element is only 1 if **at least one** input is 1, that is, at least one of the contacts is closed.

At an unused block input (x): x = 0.

#### OR function logic table

1	2	3	4	Q
0	0	0	0	0
0	0	0	1	1
0	0	1	0	1
0	0	1	1	1
0	1	0	0	1
0	1	0	1	1
0	1	1	0	1
0	1	1	1	1
1	0	0	0	1
1	0	0	1	1
1	0	1	0	1
1	0	1	1	1
1	1	0	0	1
1	1	0	1	1
1	1	1	0	1
1	1	1	1	1

## 4.2.6 NOR (not OR)

Circuit diagram of a series circuit with several break contacts:

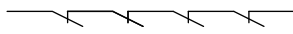

Symbol in IDEC SmartRelay:

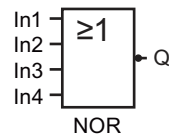

The output status of the NOR is only 1 if **all** inputs are 0, that is, off. The NOR output is set to 0 when one of the inputs is on (logical 1 status).

At an unused block input (x):  $x = 0$ .

### NOR function logic table

1	2	3	4	Q
0	0	0	0	1
0	0	0	1	0
0	0	1	0	0
0	0	1	1	0
0	1	0	0	0
0	1	0	1	0
0	1	1	0	0
0	1	1	1	0
1	0	0	0	0
1	0	0	1	0
1	0	1	0	0
1	0	1	1	0
1	1	0	0	0
1	1	0	1	0
1	1	1	0	0
1	1	1	1	0
1	1	1	1	0

### 4.2.7 XOR (exclusive OR)

The XOR in a circuit diagram, shown as series circuit with 2 changeover contacts:

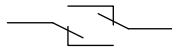

Symbol in IDEC SmartRelay:

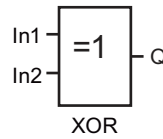

The output status of the XOR is 1 if the inputs are **not equivalent**.  
 At an unused block input (x): x = 0.

#### XOR function logic table

1	2	Q
0	0	0
0	1	1
1	0	1
1	1	0

### 4.2.8 NOT (Negation, Inverter)

A break contact in the circuit diagram:

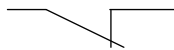

Symbol in IDEC SmartRelay:

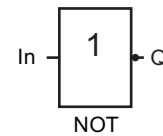

The output status is 1 if the input is 0. The NOT block inverts the input status.

An advantage of the NOT block, for example, is that you do not have to use normally closed contacts. You simply use a normally open contact and the NOT block to convert these into a normally closed contact.

#### NOT function logic table

1	Q
0	1
1	0

## 4.3 Special functions

Because of their different input designation, you can see right away that there is a difference between the special functions and basic functions. Special functions (SFs) contain timer functions, retentive functions and various parameter assignment options, which allow you to adapt the circuit program to suit your own requirements.

This section provides you with a brief overview of input designations and with some particular background information on Special functions list - SF (Page 129).

### 4.3.1 Designation of the inputs

#### Logical inputs

The following connectors enable you to create a logical link to other blocks or to the inputs of the IDEC SmartRelay unit:

- **S (Set):**  
A signal at input S sets the output to logical "1".
- **R (Reset):**  
The reset input R takes priority over all other inputs and resets the outputs.
- **Trg (Trigger):**  
This input triggers the start of a function.
- **Cnt (Count):**  
This input counts pulses.
- **Fre (Frequency):**  
IDEC SmartRelay applies frequency signals to be evaluated to this input.
- **Dir (Direction):**  
This input determines the direction, + or -.
- **En (Enable):**  
This input enables a block function. When this input is "0", the block ignores all other signals.
- **Inv (Invert):**  
A signal at this input inverts the output signal of the block.
- **Ral (Reset all):**  
A signal at this input resets all internal values.
- **Lap (for the stopwatch function)**  
A signal at this input pauses the stopwatch.

---

#### Note

Unused logical inputs of special functions default to logical "0".

---

#### Connector X at SF inputs

The connector "x" input for any SF input is low. That is, the input carries a "lo" signal.



### Parameter inputs

At some of the inputs you do not apply any signals. You configure the relevant block values instead. Examples:

- **Par (Parameter):**  
You do not connect the Par parameter. Instead, you set the relevant block parameters (times, on/off thresholds etc.).
- **Priority:**  
This is an open input. Here, you define priorities and specify whether a message is to be acknowledged in RUN.

### 4.3.2 Time response

#### Parameter T

You can configure a time value T for some of the SF blocks. When you preset this time, note that your input values are based on the timebase set:

Timebase	__ : __
s (seconds)	seconds : $\frac{1}{100}$ seconds
m (minutes)	minutes : seconds
h (hours)	hours : minutes

B6      1/1 +/- T =04:10h	Setting a time T of 250 minutes: Unit in hours h: 04:00 hours      240 minutes 00:10 hours      +10 minutes =                    250 minutes
------------------------------	--

The IDEC SmartRelay FL1F-specific Stopwatch (Page 167) function provides an additional timebase - 10 ms.

#### Accuracy of T

Because of slight tolerances in the characteristics of electronic components, the set time T can deviate. You can find a detailed description of such deviations in the On-delay (Page 134).

#### Accuracy of the timer (Seven-day/twelve-month time switch)

To prevent timing inaccuracy of the real-time clock in C versions (IDEC SmartRelay devices with an integrated real-time clock) caused by this deviation, IDEC SmartRelay continuously compares the timer value to a high-precision timebase and makes continual corrections. The resultant maximum timing inaccuracy is  $\pm 2$  s/day.

### 4.3.3 Backup of the real-time clock

Because IDEC SmartRelay backs up the internal real-time clock, it continues operation after a power failure. The surrounding temperature influences the backup time. At a surrounding temperature of 25°C, the typical backup time of an IDEC SmartRelay is 20 days.

If there is a power outage of an IDEC SmartRelay for more than 20 days, on restarting, the internal clock is back in the status that it was in before the power outage.

### 4.3.4 Retentivity

You can set the switching states, counter and time values of many Special functions list - SF (Page 129) to be retentive. This means that IDEC SmartRelay retains current data values after a power failure, and that the block resumes operation at the break point. The timer is not reset, but resumes operation until the time-to-go has expired.

To enable this response, however, the relevant functions must be set retentive. Two options are available:

R: The data is retentive.

/: Current data is not retentive (default). See the section in topic "Second circuit program (Page 78)" on enabling and disabling retentivity.

The operating hours counter, seven-day time switch, twelve-month time switch and PI controller are always retentive.

### 4.3.5 Parameter protection

In the parameter protection settings, you can determine whether or not you display and edit the parameters in IDEC SmartRelay parameter assignment mode. Two options are available:

+: The parameter attribute permits read/write access in parameter assignment mode (default).

-: The parameter settings are read-/write-protected in parameter assignment mode, and you can only edit them in programming mode. See the parameter protection mode example in the Second circuit program (Page 78).

---

#### Note

Parameter protection covers only the "Set Parameter" window. If you embed variables of protected special functions in a message text, the variables are still editable from the message text. To protect these variables, you must also activate the protection of the message text.

---

### 4.3.6 Calculating the gain and offset of analog values

A sensor is connected to the analog input and converts a process variable into an electrical signal. This value of signal lies within the typical range of this sensor.

IDEC SmartRelay always converts the electrical signals at the analog input into digital values from 0 to 1000.

IDEC SmartRelay internally transforms a voltage of 0 V to 10 V at input AI to a range of values from 0 to 1000. IDEC SmartRelay interprets an input voltage exceeding 10 V as internal value 1000.

Because you cannot always process the range of values from 0 to 1000 as predetermined by IDEC SmartRelay, you can multiply the digital values by a gain factor and then shift the zero of the range of values (offset). This allows you to output an analog value to the IDEC SmartRelay onboard display that is proportional to the actual process variable.

Parameter	Minimum	Maximum
Input voltage (in V)	0	≥ 10
Internal value	0	1000
Gain	-10.00	+10.00
Offset	-10000	+10000

#### Mathematical rule

$$\text{Actual value } Ax = (\text{internal value at input } Ax \cdot \text{gain}) + \text{offset}$$

#### Gain and offset calculation

IDEC SmartRelay calculates the gain and offset based on the relevant high and low values of the function.

Example 1:

The available thermocouples have the following technical data: -30 °C to +70 °C, 0 to 10 VDC (that is, 0 to 1000 in IDEC SmartRelay).

$$\text{Actual value} = (\text{internal value} \cdot \text{gain}) + \text{offset, thus}$$

$$-30 = (0 \cdot A) + B, \text{ that is, offset } B = -30$$

$$+70 = (1000 \cdot A) - 30, \text{ that is, gain } A = 0.1$$

Example 2:

A pressure sensor converts a pressure of 1000 mbar into a voltage of 0 V, and a pressure of 5000 mbar into a voltage of 10 V.

$$\text{Actual value} = (\text{internal value} \cdot \text{gain}) + \text{offset, thus}$$

$$1000 = (0 \cdot A) + B, \text{ that is, offset } B = 1000$$

$$5000 = (1000 \cdot A) + 1000, \text{ that is, gain } A = 4$$

### Example of analog values

Process variable	Voltage (V)	Internal value	Gain	Offset	Value shown (Ax)
-30 °C	0	0	0.1	-30	-30
0 °C	3	300	0.1	-30	0
+70 °C	10	1000	0.1	-30	70
1000 mbar	0	0	4	1000	1000
3700 mbar	6.75	675	4	1000	3700
5000 mbar	10	1000	4	1000	5000
	0	0	0.01	0	0
	5	500	0.01	0	5
	10	1000	0.01	0	10
	0	0	1	0	0
	5	500	1	0	500
	10	1000	1	0	1000
	0	0	10	0	0
	5	500	10	0	5000
	10	1000	10	0	10000
	0	0	0.01	5	5
	5	500	0.01	5	10
	10	1000	0.01	5	15
	0	0	1	500	500
	5	500	1	500	1000
	10	1000	1	500	1500
	0	0	1	-200	-200
	5	500	1	-200	300
	10	1000	1	-200	800
	0	0	10	-10000	-10000
	10	1000	10	-10000	0
	0.02	2	0.01	0	0
	0.02	2	0.1	0	0
	0.02	2	1	0	2
	0.02	2	10	0	20

For further information on a sample application, refer to the "Analog comparator (Page 184)" topic.

For further information on analog inputs, refer to the Constants and connectors (Page 113) topic.



## 4.4 Special functions list - SF

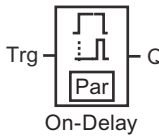
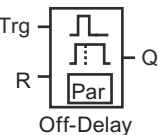
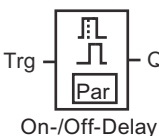
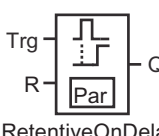
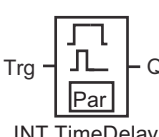
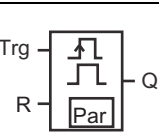
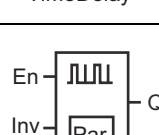
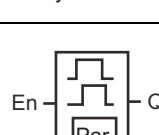
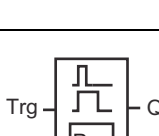

When you create your circuit program in IDEC SmartRelay, you find the special function blocks in the SF list.

You can invert the inputs of SFs individually, that is, the circuit program converts a logical "1" at the input into a logical "0"; a logical "0" it converts into a logical "1". See the programming example in topic "Circuit program input (Page 65)".

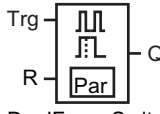
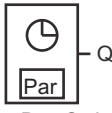
The table also specifies whether the relevant function can be set retentive (REM). The following SFs are available:

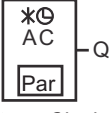
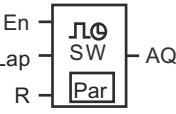
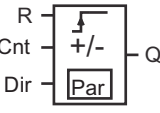
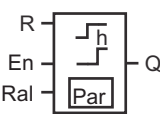
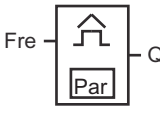
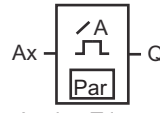
View in IDEC SmartRelay	Name of the special function	REM
<b>Timers</b>		
 <p>On-Delay</p>	On-delay (Page 134)	REM
 <p>Off-Delay</p>	Off-delay (Page 137)	REM
 <p>On-/Off-Delay</p>	On-/off-delay (Page 139)	REM
 <p>RetentiveOnDelay</p>	Retentive on-delay (Page 141)	REM
 <p>INT TimeDelay</p>	Interval time-delay relay/Pulse output (Page 143)	REM
 <p>ET INT TimeDelay</p>	Edge-triggered interval time-delay relay (Page 145)	REM
 <p>Async. Pulse</p>	Asynchronous pulse generator (Page 147)	REM
 <p>Random Generator</p>	Random generator (Page 149)	
 <p>StairLightSwitch</p>	Stairwell light switch (Page 151)	REM

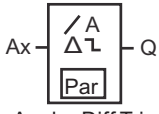
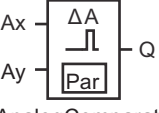
View in IDEC SmartRelay	Name of the special function	REM
 <p>DualFunc. Switch</p>	Dual-function switch (Page 153)	REM
 <p>Seven-Day Switch</p>	Seven-day time switch (Page 156)	
 <p>12-Month Switch</p>	Twelve-month time switch (Page 159)	
 <p>Astron. Clock</p>	Astronomical clock (Page 164)	
 <p>Stopwatch</p>	Stopwatch (Page 167)	
<b>Counter</b>		
 <p>Up/Down Counter</p>	Up/down counter (Page 169)	REM
 <p>Hours Counter</p>	Operating hours counter (Page 172)	REM
 <p>FrequencyTrigger</p>	Frequency trigger (Page 176)	
<b>Analog</b>		
 <p>Analog Trigger</p>	Analog trigger (Page 179)	

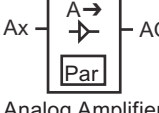
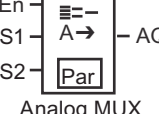
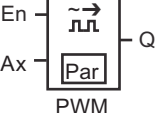
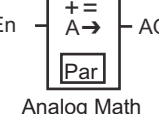
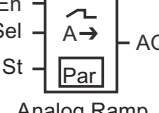
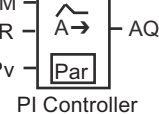
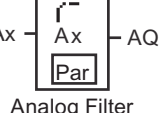
View in IDEC SmartRelay	Name of the special function	REM
 <p>AnalogDiff.Trig</p>	Analog differential trigger (Page 182)	
 <p>AnalogComparator</p>	Analog comparator (Page 184)	
 <p>Analog Watchdog</p>	Analog watchdog (Page 189)	
 <p>Analog Amplifier</p>	Analog amplifier (Page 192)	
 <p>Analog MUX</p>	Analog multiplexer (Page 210)	
 <p>PWM</p>	Pulse width modulator (PWM) (Page 222)	
 <p>Analog Math</p>	Analog Math (Page 225)	
 <p>Analog Ramp</p>	Analog ramp control (Page 213)	
 <p>PI Controller</p>	PI controller (Page 217)	REM
 <p>Analog Filter</p>	Analog filter (Page 230)	

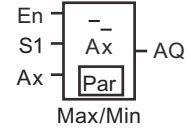
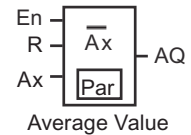
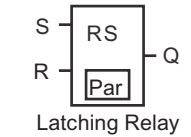
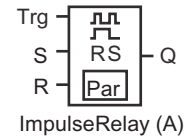
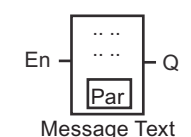
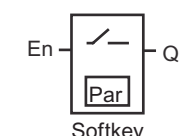
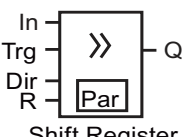
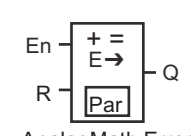
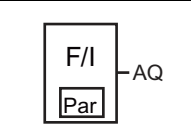
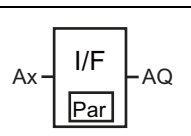
View in IDEC SmartRelay	Name of the special function	REM
 <p>Max/Min</p>	Max/Min (Page 232)	REM
 <p>Average Value</p>	Average value (Page 236)	REM
<b>Miscellaneous</b>		
 <p>Latching Relay</p>	Latching relay (Page 194)	REM
 <p>ImpulseRelay (A)</p>	Current impulse relay (Page 195)	REM
 <p>Message Text</p>	Message texts (Page 197)	
 <p>Softkey</p>	Softkey (Page 206)	REM
 <p>Shift Register</p>	Shift register (Page 208)	REM
 <p>AnalogMath Error</p>	Analog Math error detection (Page 228)	
 <p>FIConverter</p>	Float/Integer Converter (Page 238)	
 <p>IFConverter</p>	Integer/Float Converter (Page 240)	



### 4.4.1 On-delay

#### Short description

The output is only set after a configurable on-delay time expires.

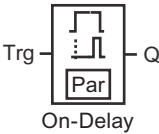
Symbol in IDEC SmartRelay	Wiring	Description
	Input Trg	A signal at input Trg (Trigger) triggers the on-delay timer.
	Parameter	T represents the time after which the output is on (0 to 1 transition of the output signal). Retentivity: / = no retentivity R = the status is retentive.
	Output Q	Q is on when the set time T expires, provided Trg is still set.

#### Parameter T

Note the defaults for parameter T in topic Time response (Page 126).

The actual value of another already-configured functions can provide the time for parameter T. You can use the actual values of the following functions for the value of T:

- Analog comparator (Page 184)(actual value Ax - Ay)
- Analog trigger (Page 179)(actual value Ax)
- Analog amplifier (Page 192)(actual value Ax)
- Analog multiplexer (Page 210)(actual value AQ)
- Analog ramp control (Page 213)(actual value AQ)
- Analog Math (Page 225) (actual value AQ)
- PI controller (Page 217)(actual value AQ)
- Up/down counter (Page 169)(actual value Cnt)
- Analog filter (Page 230) (actual value AQ)
- Average value (Page 236) (actual value AQ)
- Max/Min (Page 232) (actual value AQ)
- On-delay (current time Ta)
- Off-delay (Page 137)(current time Ta)
- On-/off-delay (Page 139)(current time Ta)
- Retentive on-delay (Page 141)(current time Ta)
- Interval time-delay relay/Pulse output (Page 143)(current time Ta)
- Edge-triggered interval time-delay relay (Page 145)(current time Ta)
- Asynchronous pulse generator (Page 147)(current time Ta)
- Stairwell light switch (Page 151)(current time Ta)
- Dual-function switch (Page 153)(current time Ta)
- Stopwatch (Page 167)(actual value AQ)
- Frequency trigger (Page 176) (actual value Fre)

Select the required function by the block number. The timebase is configurable.

### Valid ranges of the timebase, if T = parameter

Note the following characteristics of timebase values.

Timebase	max. value	min. resolution	Accuracy
s (seconds)	99:99	10 ms	+ 10 ms
m (minutes)	99:59	1s	+ 1 s
h (hours)	99:59	1 min	+ 1 min

The parameter T initially appears as follows in programming mode, for example:

```
B12    1/1 +R
T =04:10h
```

### Valid ranges of the timebase

If an already-programmed function provides the value of T, the valid ranges of the timebase are as follows:

Timebase	max. value	Meaning	Accuracy
ms	99990	Number of ms	± 10 ms
s	5999	Number of s	± 1 s
m	5999	Number of min	± 1 min

The IDEC SmartRelay display appears as follows in programming mode, if you have, for example, set the actual value of B6 in seconds to parameter T of B12:

```
B12    1/1 +R
T →B006s
```

If the referenced block (B6, in the example) returns a value that lies out of the valid range, IDEC SmartRelay rounds the value up or down to the next valid value.

### Parameter preset = Actual value of an already-programmed function

To include the actual value of an already-programmed function for parameter T, follow these steps:

1. Press ► to move the cursor to the equal sign of parameter T.



- Press ▼ to change the equal sign into an arrow. IDEC SmartRelay displays the last referenced block if it exists.

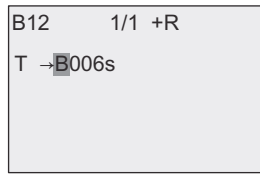

- Press ► to move the cursor to the "B" of the shown block, and then press ▼ to select the required block number.
- Press ► to move the cursor to the block's timebase and press ▼ to select the required timebase.

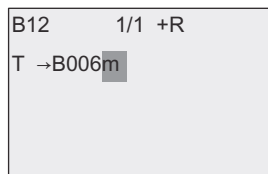

The view in parameter assignment mode appears as follows, for example:

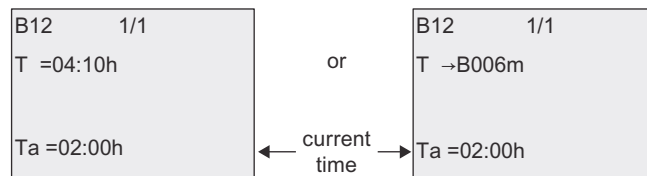

### Timing diagram

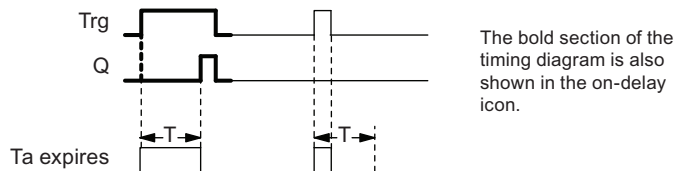

### Functional description

A 0 to 1 transition triggers the time  $T_a$  at input Trg ( $T_a$  is the current IDEC SmartRelay time).

If the status of input Trg is 1 at least for the duration of the configured time T, IDEC SmartRelay sets the output to 1 on expiration of this time (the output follows the input with on-delay).

IDEC SmartRelay resets the time when the status at input Trg returns to 0 before the time T expires.

IDEC SmartRelay resets the output to 0 when the signal at input Trg is 0.

If the block is retentive, IDEC SmartRelay resets output Q and the expired time to the values before a power failure; if the block is not retentive, IDEC SmartRelay resets output Q and the expired time to defaults after a power failure.

## 4.4.2 Off-delay

### Short description

When an On-delay (Page 134) is set, the output is reset when the configured time has expired.

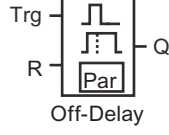
Symbol in IDEC SmartRelay	Wiring	Description
	Input Trg	The off-delay timer starts with a negative edge (1 to 0 transition) at input Trg (Trigger)
	Input R	A signal at input R resets the on-delay time and the output.
	Parameter	The output switches off (transitions from 1 to 0) when the delay time T expires. Retentivity: / = No retentivity R = The status is retentive.
	Output Q	A signal at input Trg sets Q. Q holds this state until T expires.

### Parameter T

Note the parameter T defaults specified in topic Time response (Page 126).

The actual value of another already-configured functions can provide the time for parameter T. You can use the actual value of the following functions:

- Analog comparator (Page 184) (actual value Ax - Ay)
- Analog trigger (Page 179) (actual value Ax)
- Analog amplifier (Page 192) (actual value Ax)
- Analog multiplexer (Page 210) (actual value AQ)
- Analog ramp control (Page 213) (actual value AQ)
- Analog Math (Page 225) (actual value AQ)
- PI controller (Page 217) (actual value AQ)
- Up/down counter (Page 169) (actual value Cnt)
- Analog filter (Page 230) (actual value AQ)
- Average value (Page 236) (actual value AQ)
- Max/Min (Page 232) (actual value AQ)
- On-delay (Page 134) (current time Ta)
- Off-delay (current time Ta)
- On-/off-delay (Page 139) (current time Ta)
- Retentive on-delay (Page 141) (current time Ta)
- Interval time-delay relay/Pulse output (Page 143) (current time Ta)
- Edge-triggered interval time-delay relay (Page 145) (current time Ta)
- Asynchronous pulse generator (Page 147) (current time Ta)
- Stairwell light switch (Page 151) (current time Ta)

- Dual-function switch (Page 153) (current time  $T_a$ )
- Stopwatch (Page 167) (actual value AQ)
- Frequency trigger (Page 176) (actual value Fre)

Select the required function by the block number. The timebase is configurable. For information on valid timebase ranges and parameter preset, refer to Section "On-delay (Page 134)".

### Timing diagram

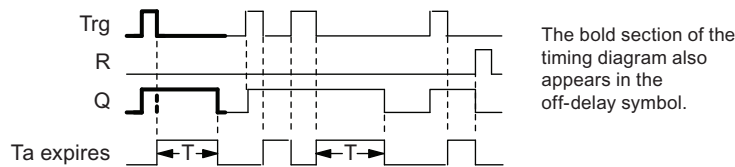

### Functional description

IDEC SmartRelay sets Output Q to hi immediately when the input Trg changes to hi.

IDEC SmartRelay retriggers the actual time  $T_a$  at the 1 to 0 transition of Trg. The output remains set. IDEC SmartRelay resets Output Q to 0 with off-delay when  $T_a$  reaches the value configured at T ( $T_a=T$ ).

IDEC SmartRelay retriggers the time  $T_a$  with a one-shot at input Trg.

You can set input R (Reset) to reset the time  $T_a$  and the output before  $T_a$  expires.

If the block is retentive, IDEC SmartRelay resets output Q and the expired time to the values before a power failure; if the block is not retentive, IDEC SmartRelay resets output Q and the expired time to defaults after a power failure.

### 4.4.3 On-/off-delay

#### Short description

The on-/off-delay function sets the output after the set on-delay time has expired, and resets it upon expiration of the off-delay time.

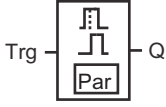
Symbol in IDEC SmartRelay	Wiring	Description
 <p>On-/Off-Delay</p>	Input Trg	<p>A positive edge (0 to 1 transition) at input Trg (Trigger) triggers the on-delay time <math>T_H</math>.</p> <p>A negative edge (1 to 0 transition) at input Trg (Trigger) triggers the off-delay time <math>T_L</math>.</p>
	Parameter	<p><math>T_H</math> is the time after which the output is set hi (output signal transition 0 to 1).</p> <p><math>T_L</math> is the time after which the output is reset ( output signal transition 1 to 0).</p> <p>Retentivity: / = No retentivity R = The status is retentive.</p>
	Output Q	<p>IDEC SmartRelay sets Q when the configured time <math>T_H</math> expires and Trg is still set. IDEC SmartRelay resets Q when <math>T_L</math> expires, if the trigger Trg has not been set.</p>

#### Parameters $T_H$ and $T_L$

Note the preset values for the parameters  $T_H$  and  $T_L$  in topic Time response (Page 126).

The actual value of another, already-configured function can provide the on-delay and off-delay times for parameters  $T_H$  and  $T_L$ . You can use the actual values of the following functions:

- Analog comparator (Page 184)(actual value Ax - Ay)
- Analog trigger (Page 179)(actual value Ax)
- Analog amplifier (Page 192)(actual value Ax)
- Analog multiplexer (Page 210)(actual value AQ)
- Analog ramp control (Page 213)(actual value AQ)
- Analog Math (Page 225) (actual value AQ)
- PI controller (Page 217)(actual value AQ)
- Up/down counter (Page 169)(actual value Cnt)
- Analog filter (Page 230) (actual value AQ)
- Average value (Page 236) (actual value AQ)
- Max/Min (Page 232) (actual value AQ)
- On-delay (Page 134)(current time Ta)
- Off-delay (Page 137)(current time Ta)
- On-/off-delay (current time Ta)
- Retentive on-delay (Page 141)(current time Ta)

- Interval time-delay relay/Pulse output (Page 143)(current time Ta)
- Edge-triggered interval time-delay relay (Page 145)(current time Ta)
- Asynchronous pulse generator (Page 147)(current time Ta)
- Stairwell light switch (Page 151)(current time Ta)
- Dual-function switch (Page 153)(current time Ta)
- Stopwatch (Page 167)(actual value AQ)
- Frequency trigger (Page 176) (actual value Fre)

Select the required function by the block number. The timebase is configurable. For information on valid timebase ranges and parameter preset, refer to Section "On-delay (Page 134)".

### Timing diagram

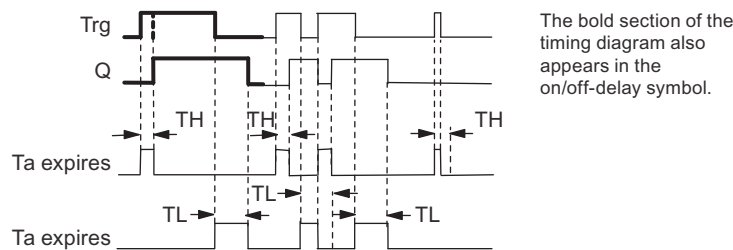

### Functional description

The time  $T_H$  is triggered with a 0 to 1 transition at input Trg.

If the status at input Trg is 1 at least for the duration of the time  $T_H$ , IDEC SmartRelay sets the output to 1 on expiration of the time  $T_H$  (the output follows the input with on-delay).

IDEC SmartRelay resets the time when IDEC SmartRelay resets the signal at input Trg to 0 before the time  $T_H$  expires.

A 1 to 0 transition at input Trg triggers the time  $T_L$ .

If the status at input Trg is 0 at least for the duration of the signal  $T_L$ , IDEC SmartRelay sets the output to 0 on expiration of the time  $T_L$  (the output follows the input with off-delay).

IDEC SmartRelay resets the time when the signal at input Trg changes to 1 again before the time  $T_L$  expires.

If the block is retentive, IDEC SmartRelay resets output Q and the expired time to the values before a power failure; if the block is not retentive, IDEC SmartRelay resets output Q and the expired time to defaults after a power failure.

## 4.4.4 Retentive on-delay

### Short description

A one-shot at the input triggers a configurable on-delay time. The output is set when this time has expired.

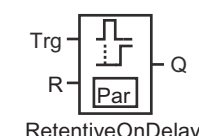
Symbol in IDEC SmartRelay	Wiring	Description
 <p>RetentiveOnDelay</p>	Input Trg	A signal at input Trg (Trigger) triggers the on-delay timer.
	Input R	A signal at input R resets the on-delay time and the output.
	Parameter	T represents the on-delay time for the output (output status transition 0 to 1). Retentivity: / = no retentivity R = The status is retentive.
	Output Q	IDEC SmartRelay sets output Q after the time T expires.

### Parameter T

Note the defaults specified in topic Time response (Page 126).

The actual value of another already-programmed function can provide the time for parameter T. You can use the actual values of the following functions:

- Analog comparator (Page 184)(actual value Ax – Ay)
- Analog trigger (Page 179)(actual value Ax)
- Analog amplifier (Page 192)(actual value Ax)
- Analog multiplexer (Page 210)(actual value AQ)
- Analog ramp control (Page 213)(actual value AQ)
- Analog Math (Page 225) (actual value AQ)
- PI controller (Page 217)(actual value AQ)
- Up/down counter (Page 169)(actual value Cnt)
- Analog filter (Page 230) (actual value AQ)
- Average value (Page 236) (actual value AQ)
- Max/Min (Page 232) (actual value AQ)
- On-delay (Page 134)(current time Ta)
- Off-delay (Page 137)(current time Ta)
- On-/off-delay (Page 139)(current time Ta)
- Retentive on-delay (current time Ta)



- Interval time-delay relay/Pulse output (Page 143)(current time  $T_a$ )
- Edge-triggered interval time-delay relay (Page 145)(current time  $T_a$ )
- Asynchronous pulse generator (Page 147)(current time  $T_a$ )
- Stairwell light switch (Page 151)(current time  $T_a$ )
- Dual-function switch (Page 153)(current time  $T_a$ )
- Stopwatch (Page 167)(actual value  $AQ$ )
- Frequency trigger (Page 176) (actual value  $Fre$ )

Select the required function by the block number. The timebase is configurable. For information on valid ranges and parameter defaults, refer to Section "On-delay (Page 134)".

### Timing diagram

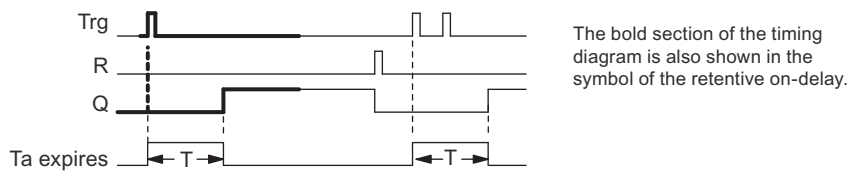

### Functional description

The 0 to 1 signal transition at input Trg triggers the current time  $T_a$ . IDEC SmartRelay sets output Q when  $T_a = T$ . A further signal at input Trg does not influence the time  $T_a$ .

IDEC SmartRelay resets the output and the time  $T_a$  with the next 1 signal at input R.

If the block is retentive, IDEC SmartRelay resets output Q and the expired time to the values before a power failure; if the block is not retentive, IDEC SmartRelay resets output Q and the expired time to defaults after a power failure.

## 4.4.5 Interval time-delay relay/Pulse output

### Short description

An input signal generates a signal with a configurable period at the output.

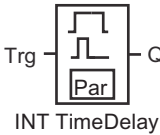
Symbol in IDEC SmartRelay	Wiring	Description
 <p style="text-align: center;">INT TimeDelay</p>	Input Trg	A signal at input Trg (Trigger) triggers the time for the interval time-delay relay function.
	Parameter	The output is switched off after the time T has expired (output signal transition 1 to 0). Retentivity: / = No retentivity R = The status is retentive.
	Output Q	A signal at input Trg sets Q. If the input signal = 1, output Q remains set for the time Ta.

### Parameter T

Note the information on parameter T in topic Time response (Page 126).

The actual value of another already-programmed function can provide the time for parameter T. You can use the actual values of the following functions:

- Analog comparator (Page 184)(actual value Ax – Ay)
- Analog trigger (Page 179)(actual value Ax)
- Analog amplifier (Page 192)(actual value Ax)
- Analog multiplexer (Page 210)(actual value AQ)
- Analog ramp control (Page 213)(actual value AQ)
- Analog Math (Page 225) (actual value AQ)
- PI controller (Page 217)(actual value AQ)
- Up/down counter (Page 169)(actual value Cnt)
- Analog filter (Page 230) (actual value AQ)
- Average value (Page 236) (actual value AQ)
- Max/Min (Page 232) (actual value AQ)
- On-delay (Page 134)(current time Ta)
- Off-delay (Page 137)(current time Ta)
- On-/off-delay (Page 139)(current time Ta)
- Retentive on-delay (Page 141)(current time Ta)
- Interval time-delay relay/Pulse output (Page 143) (current time Ta)
- Edge-triggered interval time-delay relay (Page 145)(current time Ta)
- Asynchronous pulse generator (Page 147)(current time Ta)
- Stairwell light switch (Page 151)(current time Ta)
- Dual-function switch (Page 153)(current time Ta)

- Stopwatch (Page 167)(actual value AQ)
- Frequency trigger (Page 176) (actual value Fre)

Select the required function by the block number. The timebase is configurable. For information on valid ranges and parameter defaults, refer to Section "On-delay (Page 134)".

### Timing diagram

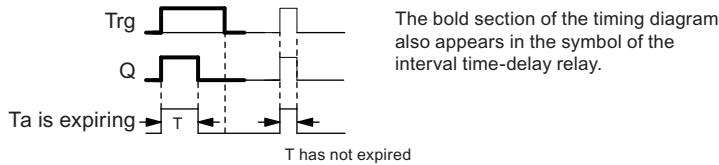

### Functional description

A 0 to 1 transition at input Trg sets the output, and triggers a time  $T_a$  during which the output remains set.

IDEC SmartRelay resets output Q to lo (pulse output) when  $T_a$  reaches the value preset at T ( $T_a = T$ ).

IDEC SmartRelay sets the output immediately if there is a 1 to 0 transition at input Trg before the specified time expires.

If the block is retentive, IDEC SmartRelay resets output Q and the expired time to the values before a power failure; if the block is not retentive, IDEC SmartRelay resets output Q and the expired time to defaults after a power failure.

## 4.4.6 Edge-triggered interval time-delay relay

### Short description

An input pulse generates a preset number of output pulses with a defined pulse/pause ratio (retriggerable), after a configured delay time has expired.

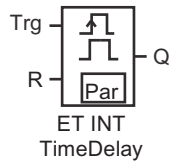
Symbol in IDEC SmartRelay	Wiring	Description
	Input Trg	A signal at input Trg (Trigger) triggers the times for the edge-triggered interval time-delay relay.
	Input R	A signal at input R resets the current time ( $T_a$ ) and the output.
	Parameter	<p>The interpulse width <math>T_L</math> and the pulse width <math>T_H</math> are configurable.</p> <p>N determines the number of pulse/pause cycles TL/TH: Range of values: 1...9</p> <p>Retentivity: / = No retentivity R = The status is retentive.</p>
	Output Q	Q is set after $T_L$ expires, and reset after $T_H$ expires.

### Parameters TH and TL

Note the information on parameter T in topic Time response (Page 126).

The actual value of another already-programmed function can provide the pulse width TH and the interpulse width TL. You can use the actual values of the following functions:

- Analog comparator (Page 184) (actual value Ax – Ay)
- Analog trigger (Page 179) (actual value Ax)
- Analog amplifier (Page 192) (actual value Ax)
- Analog multiplexer (Page 210) (actual value AQ)
- Analog ramp control (Page 213) (actual value AQ)
- Analog Math (Page 225) (actual value AQ)
- PI controller (Page 217) (actual value AQ)
- Up/down counter (Page 169) (actual value Cnt)
- Analog filter (Page 230) (actual value AQ)
- Average value (Page 236) (actual value AQ)
- Max/Min (Page 232) (actual value AQ)
- On-delay (Page 134) (current time  $T_a$ )
- Off-delay (Page 137) (current time  $T_a$ )
- On-/off-delay (Page 139) (current time  $T_a$ )
- Retentive on-delay (Page 141) (current time  $T_a$ )
- Interval time-delay relay/Pulse output (Page 143) (current time  $T_a$ )
- Edge-triggered interval time-delay relay (Page 145) (current time  $T_a$ )

- Asynchronous pulse generator (Page 147) (current time  $T_a$ )
- Stairwell light switch (Page 151) (current time  $T_a$ )
- Dual-function switch (Page 153) (current time  $T_a$ )
- Stopwatch (Page 167) (actual value  $AQ$ )
- Frequency trigger (Page 176) (actual value  $Fre$ )

Select the required function by the block number. The timebase is configurable. For information on valid ranges and parameter defaults, refer to the On-delay (Page 134) topic.

### Timing diagram A

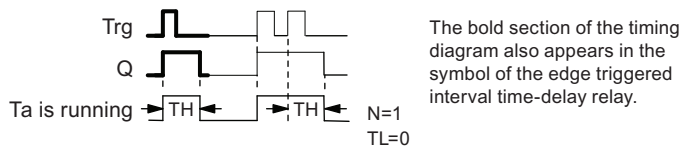

### Timing diagram B

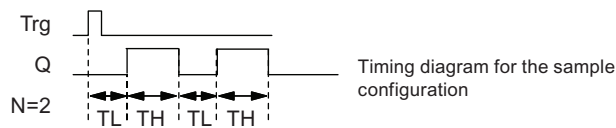

### Functional description

A 0 to 1 transition at input Trg triggers the time  $T_L$  (Time Low). After the time  $T_L$  has expired, output Q is set for the duration of  $T_H$  (Time High).

If there is a further 0 to 1 transition (retriggering pulse) at input Trg before the preset time ( $T_L + T_H$ ) has expired,  $T_a$  is reset and the pulse/pause cycle is restarted.

If the block is retentive, IDEC SmartRelay resets output Q and the expired time to the values before a power failure; if the block is not retentive, IDEC SmartRelay resets output Q and the expired time to defaults after a power failure.

## Setting the Par parameter

View in programming mode (example):

B25	1/1 +R	← Protection mode and retentivity
TH =03:00s		← Interpulse width
TL =02:00s		← Pulse width
No =1		← Number of pulse/pause cycles (example)

View in parameter assignment mode (example):

B25	1/1	
TH =03:00s		
TL =02:00s		
Ta =01:15s		← Current pulse width $T_L$ or $T_H$

### 4.4.7 Asynchronous pulse generator

#### Short description

You can asynchronously output pulses with this function.

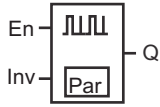
Symbol in IDEC SmartRelay	Wiring	Description
 <p>En — [Pulse] — Q Inv — [Par]</p> <p>Async. Pulse</p>	Input En	You can use input EN to set and reset the asynchronous pulse generator.
	Input Inv	You can use input Inv to invert the output signal of the active asynchronous pulse generator.
	Parameter	You can configure the pulse width $T_H$ and the interpulse width $T_L$ . Retentivity: / = No retentivity R = The status is retentive.
	Output Q	The pulse and pause values cyclically set and reset Q.

#### Parameters TH and TL

Note the information on parameter T in topic Time response (Page 126)

The actual value of another already-programmed function can provide the pulse width TH and the interpulse width TL. You can use the actual values of the following functions:

- Analog comparator (Page 184) (actual value Ax – Ay)
- Analog trigger (Page 179) (actual value Ax)
- Analog amplifier (Page 192) (actual value Ax)
- Analog multiplexer (Page 210) (actual value AQ)

- Analog ramp control (Page 213) (actual value AQ)
- Analog Math (Page 225) (actual value AQ)
- PI controller (Page 217) (actual value AQ)
- Up/down counter (Page 169) (actual value Cnt)
- Analog filter (Page 230) (actual value AQ)
- Average value (Page 236) (actual value AQ)
- Max/Min (Page 232) (actual value AQ)
- On-delay (Page 134) (current time Ta)
- Off-delay (Page 137) (current time Ta)
- On-/off-delay (Page 139) (current time Ta)
- Retentive on-delay (Page 141) (current time Ta)
- Interval time-delay relay/Pulse output (Page 143) (current time Ta)
- Edge-triggered interval time-delay relay (Page 145) (current time Ta)
- Aysnchronous pulse generator (current time Ta)
- Stairwell light switch (Page 151) (current time Ta)
- Dual-function switch (Page 153) (current time Ta)
- Stopwatch (Page 167) (actual value AQ)
- Frequency trigger (Page 176) (actual value Fre)

Select the required function by the block number. The timebase is configurable. For information on valid ranges and parameter defaults, refer to the On-delay (Page 134) topic.

### Timing diagram

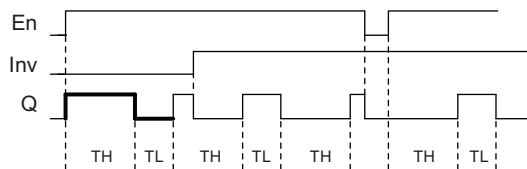

### Functional description

You can configure the pulse/interpulse width at the  $T_H$  (Time High) and  $T_L$  (Time Low) parameters.

Input Inv can be used to invert the output signal, provided the block is enabled with a signal at input EN.

If the block is retentive, IDEC SmartRelay resets output Q and the expired time to the values before a power failure; if the block is not retentive, IDEC SmartRelay resets output Q and the expired time to defaults after a power failure.

## 4.4.8 Random generator

### Short description

The random generator function sets an output randomly within a configured time.

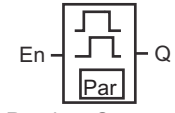
Symbol in IDEC SmartRelay	Wiring	Description
 <p>Random Generator</p>	Input En	A positive edge ( 0 to 1 transition) at input En (Enable) triggers the on-delay time of the random generator. A negative edge ( 1 to 0 transition) at input En (Enable) triggers the off-delay time of the random generator.
	Parameter	IDEC SmartRelay sets the on-delay at random to a value between 0 s and $T_H$ . The off-delay is set at random to a value between 0 s and $T_L$ .
	Output Q	IDEC SmartRelay sets output Q when the on-delay expires and if En is still set. IDEC SmartRelay resets Q when the off-delay expires, provided IDEC SmartRelay has not set En again meanwhile.

### Parameter $T_H$ and $T_L$

Note the defaults of the  $T_H$  and  $T_L$  parameters listed in topic Time response (Page 126).

The actual value of another already-programmed function can provide the on-delay time  $T_H$  and the off-delay time  $T_L$ . You can use the actual values of the following functions:

- Analog comparator (Page 184) (actual value  $A_x - A_y$ )
- Analog trigger (Page 179) (actual value  $A_x$ )
- Analog amplifier (Page 192) (actual value  $A_x$ )
- Analog multiplexer (Page 210) (actual value  $A_Q$ )
- Analog ramp control (Page 213) (actual value  $A_Q$ )
- Analog Math (Page 225) (actual value  $A_Q$ )
- PI controller (Page 217) (actual value  $A_Q$ )
- Up/down counter (Page 169) (actual value  $Cnt$ )
- Analog filter (Page 230) (actual value  $A_Q$ )
- Average value (Page 236) (actual value  $A_Q$ )
- Max/Min (Page 232) (actual value  $A_Q$ )
- On-delay (Page 134) (current time  $T_a$ )
- Off-delay (Page 137) (current time  $T_a$ )
- On-/off-delay (Page 139) (current time  $T_a$ )
- Retentive on-delay (Page 141) (current time  $T_a$ )



- Interval time-delay relay/Pulse output (Page 143) (current time  $T_a$ )
- Edge-triggered interval time-delay relay (Page 145) (current time  $T_a$ )
- Asynchronous pulse generator (Page 147) (current time  $T_a$ )
- Stairwell light switch (Page 151) (current time  $T_a$ )
- Dual-function switch (Page 153) (current time  $T_a$ )
- Stopwatch (Page 167) (actual value  $AQ$ )
- Frequency trigger (Page 176) (actual value  $Fre$ )

Select the required function by the block number. The timebase is configurable. For information on valid ranges and parameter defaults, refer to the On-delay (Page 134) topic.

### Timing diagram

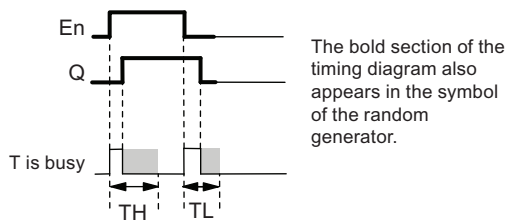

### Functional description

The 0 to 1 transition at input  $E_n$  triggers a random on-delay time between 0 s and  $T_H$ . The output is set when the on-delay time expires and if the signal at input  $E_n$  remains hi at least for the duration of this time.

The time is reset if input  $E_n$  is reset before the on-delay time has expired.

A 1 to 0 transition at input  $E_n$  triggers a random off-delay time between 0 s and  $T_L$ .

IDEC SmartRelay resets the output after the off-delay time expires, provided input  $E_n$  remains lo at least for the duration of this time.

IDEC SmartRelay resets the time if the signal at input  $E_n$  changes to 1 again before the off-delay time expires.

If the block is retentive, IDEC SmartRelay resets output  $Q$  and the expired time to the values before a power failure; if the block is not retentive, IDEC SmartRelay resets output  $Q$  and the expired time to defaults after a power failure.

## 4.4.9 Stairwell light switch

### Short description

An input edge triggers a configurable and retriggerable time. IDEC SmartRelay resets the output after this time expires. IDEC SmartRelay can optionally output a warning signal to warn of the impending time expiration.

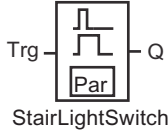
Symbol in IDEC SmartRelay	Wiring	Description
	Input Trg	A signal at input Trg (Trigger) triggers the off-delay time for the stairwell light switch.
	Parameter	<p>T represents the off-delay time of the output (output signal transition 1 to 0).</p> <p>T<sub>I</sub> determines the triggering time for the pre-warning.</p> <p>T<sub>IL</sub> determines the length of the pre-warning signal.</p> <p>Retentivity: / = No retentivity R = The status is retentive.</p>
	Output Q	<p>IDEC SmartRelay resets Q after the time T expires.</p> <p>IDEC SmartRelay outputs a warning signal before this time expires.</p>

### Parameter T, T<sub>I</sub> and T<sub>IL</sub>

Note the defaults of the T parameters listed in topic Time response (Page 126).

The actual value of another already-programmed function can provide the off-delay time T, the pre-warning time T<sub>I</sub> and the pre-warning period T<sub>IL</sub>. You can use the actual values of the following functions:

- Analog comparator (Page 184) (actual value Ax – Ay)
- Analog trigger (Page 179) (actual value Ax)
- Analog amplifier (Page 192) (actual value Ax)
- Analog multiplexer (Page 210) (actual value AQ)
- Analog ramp control (Page 213) (actual value AQ)
- Analog Math (Page 225) (actual value AQ)
- PI controller (Page 217) (actual value AQ)
- Up/down counter (Page 169) (actual value Cnt)
- Analog filter (Page 230) (actual value AQ)
- Average value (Page 236) (actual value AQ)
- Max/Min (Page 232) (actual value AQ)
- On-delay (Page 134) (current time Ta)
- Off-delay (Page 137) (current time Ta)
- On-/off-delay (Page 139) (current time Ta)
- Retentive on-delay (Page 141) (current time Ta)
- Interval time-delay relay/Pulse output (Page 143) (current time Ta)

- Edge-triggered interval time-delay relay (Page 145) (current time  $T_a$ )
- Asynchronous pulse generator (Page 147) (current time  $T_a$ )
- Stairwell light switch (Page 151) (current time  $T_a$ )
- Dual-function switch (Page 153) (current time  $T_a$ )
- Stopwatch (Page 167) (actual value  $AQ$ )
- Frequency trigger (Page 176) (actual value  $Fre$ )

Select the required function by the block number. The timebase is configurable. For information on valid ranges and parameter defaults, refer to the On-delay (Page 134) topic.

### Timing diagram

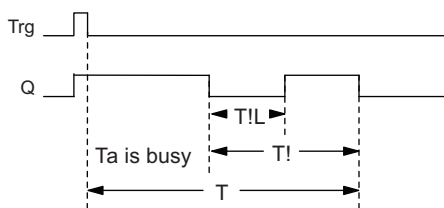

### Functional description

A 0 to 1 signal transition at input Trg sets output Q. The next 1 to 0 transition at Trg retriggers the current time  $T_a$ , and output Q remains set.

IDEC SmartRelay resets output Q when  $T_a = T$ . You can output a warning signal before the off-delay time  $(T - T_i)$  expires to reset Q for the time of the pre-warning period  $T_{iL}$ .

A further one-shot at input Trg during  $T_a$  retriggers the time  $T_a$ .

If the block is retentive, IDEC SmartRelay resets output Q and the expired time to the values before a power failure; if the block is not retentive, IDEC SmartRelay resets output Q and the expired time to defaults after a power failure.

### Setting the Par parameter

Note the defaults specified in topic Time response (Page 126).

#### Note

All times must have the same timebase.

View in programming mode (example):

B9	1/1	1+R	← Protection mode and retentivity
T	=60:00s		← Off-delay time
T!	=05:00s		← Start of the off-warning period( $T - T_i$ )
T!L	=00:10s		← Off-warning time

View in parameter assignment mode (example):

B9	1/1
T	=60:00s
T!	=05:00s
T!L	=00:10s
Ta	=06:00s

← Current value of T

## 4.4.10 Dual-function switch

### Short description

The dual-function switch provides two different functions:

- Pulse switch with off-delay
- Switch (permanent lighting)

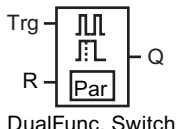
Symbol in IDEC SmartRelay	Wiring	Description
 <p>DualFunc. Switch</p>	Input Trg	A signal at input Trg (Trigger) sets output Q (permanent light) or resets Q with an off-delay. When active, output Q can be reset with a signal at input Trg.
	Input R	A signal at input R resets the current time $T_a$ and resets the output.
	Parameter	<p>T represents the off-delay time. IDEC SmartRelay resets the output (1 to 0 transition) when time T expires.</p> <p><math>T_L</math> represents the time during which the output must be set to enable the permanent light function.</p> <p><math>T_I</math> represents the on-delay for the prewarning time.</p> <p><math>T_{IL}</math> represents the length of the prewarning time period.</p> <p>Retentivity: / = No retentivity R = The status is retentive.</p>
	Output Q	A signal at Trg switches on output Q. Depending on the length of the input at Trg, the output is off again or on permanently, or it is reset with a further signal at Trg.

### Parameters T, T<sub>L</sub>, T<sub>I</sub> and T<sub>IL</sub>

Note the defaults of the T parameters listed in topic Time response (Page 126).

The actual value of another already-programmed function can provide the off-delay time T, the permanent light time T<sub>L</sub>, the on-delay prewarning time T<sub>I</sub> and the prewarning time period T<sub>IL</sub>. You can use the actual values of the following functions:

- Analog comparator (Page 184) (actual value Ax – Ay)
- Analog trigger (Page 179) (actual value Ax)
- Analog amplifier (Page 192) (actual value Ax)
- Analog multiplexer (Page 210) (actual value AQ)
- Analog ramp control (Page 213) (actual value AQ)
- Analog Math (Page 225) (actual value AQ)
- PI controller (Page 217) (actual value AQ)
- Up/down counter (Page 169) (actual value Cnt)
- Analog filter (Page 230) (actual value AQ)
- Average value (Page 236) (actual value AQ)
- Max/Min (Page 232) (actual value AQ)
- On-delay (Page 134) (current time Ta)
- Off-delay (Page 137) (current time Ta)
- On-/off-delay (Page 139) (current time Ta)
- Retentive on-delay (Page 141) (current time Ta)
- Interval time-delay relay/Pulse output (Page 143) (current time Ta)
- Edge-triggered interval time-delay relay (Page 145) (current time Ta)
- Asynchronous pulse generator (Page 147) (current time Ta)
- Stairwell light switch (Page 151) (current time Ta)
- Dual-function switch (Page 153) (current time Ta)
- Stopwatch (Page 167) (actual value AQ)
- Frequency trigger (Page 176) (actual value Fre)

Select the required function by the block number. The timebase is configurable. For information on valid ranges and parameter defaults, refer to the On-delay (Page 134) topic.

### Timing diagram

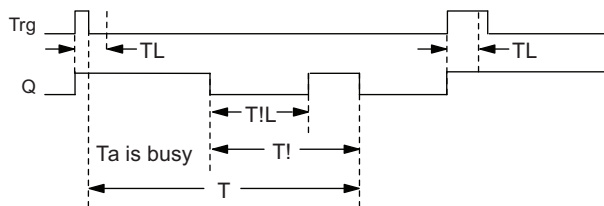

## Functional description

A 0 to 1 transition at input Trg sets output Q.

If output Q = 0, and input Trg is set hi at least for the duration of  $T_L$ , IDEC SmartRelay enables the permanent lighting function and sets output Q accordingly.

IDEC SmartRelay triggers the off-delay T when input Trg returns to 0 before  $T_L$  has expired.

Output Q is reset when  $T_a = T$ .

You can output an off-warning signal prior to the expiration of the off-delay time ( $T - T_i$ ) that resets Q for the duration of the prewarning time period  $T_{iL}$ . A subsequent signal at Trg always resets T and the output Q.

If the block is retentive, IDEC SmartRelay resets output Q and the expired time to the values before a power failure; if the block is not retentive, IDEC SmartRelay resets output Q and the expired time to defaults after a power failure.

## Setting the Par parameter

Note the defaults specified in the topic "Time response (Page 126)".

---

### Note

T,  $T_i$  and  $T_{iL}$  must all have the same timebase.

---

View in programming mode (example):

B5	1/1	+R	← Protection mode and retentivity
T	=60:00s		← Off-delay
TL	=10:00s		← Permanent light on-time
T!	=30:00s		← Start of the off-warning period( $T - T_i$ )
T!L	=20:00s		← Off-warning time

View in parameter assignment mode (example):

B5	1/1		
T	=60:00s		
TL	=10:00s		
T!	=30:00s		
T!L	=20:00s		
Ta	=06:00s		← Current value of the time $T_L$ or T

### 4.4.11 Seven-day time switch

#### Short description

The seven-day time switch controls an output by means of a configurable on/off date. The function supports any combination of weekdays. You select the active weekdays by hiding the inactive days.

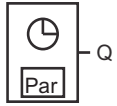
Symbol in IDEC SmartRelay	Wiring	Description
 <p>Seven-Day Switch</p>	Cam parameters 1, 2 and 3	At the Cam parameters, you set the on- and off-times of the seven-day time switch for each <b>Cam</b> switch. Here you also configure the days and the time-of-day.  You can also specify whether the timer pulses on for one cycle when activated and then reset. The pulse setting applies to all three cams.
	Output Q	IDEC SmartRelay sets Q when actuating the configured cam.

#### Timing diagram (three examples)

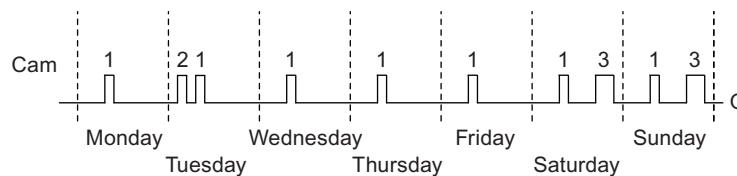

Cam 1:	Daily:	06:30 h to 8:00 h
Cam 2:	Tuesday:	03:10 h to 04:15 h
Cam 3:	Saturday and Sunday:	16:30 h to 23:10 h

#### Functional description

Each seven-day time switch has three cams for you to configure a time hysteresis. You specify the on- and off-times at the Cam parameters. The seven-day time switch sets the output at a certain on-time; if you have not set it, the seven-day time switch resets the output at a certain off-time if you configure an off-time, or at the end of the cycle if you specify a pulse output.

You will cause a conflict if you set overlapping on- and off-times; the earliest on- and off-times take priority. Here is an example:

Cam	On-time	Off-time
1	1:00h	2:00h
2	1:10h	1:50h
3	1:20h	1:40h

In this example, the work time is 1:00h to 1:40h.

The status of all three cams determines the switching state of the seven-day time switch.

## Parameter assignment screen form

View of the parameter assignment screen form, for example for Cam1 and the Pulse setting:

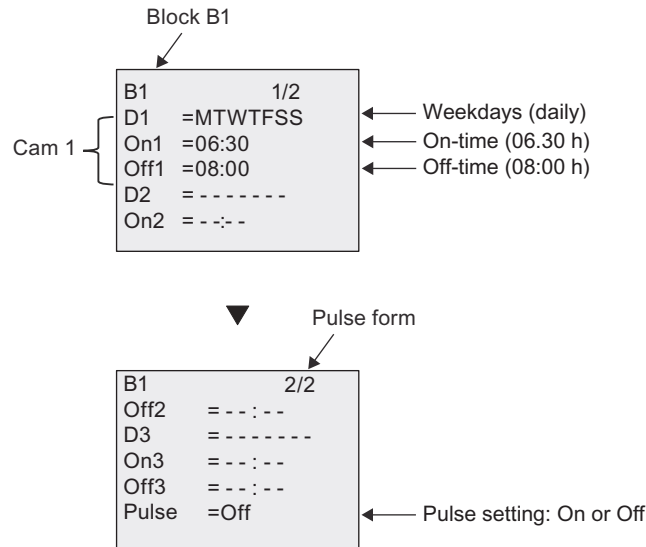

## Days of the week

The prefix "D=" (Day) has the following meaning:

- M: Monday
- T: Tuesday
- W: Wednesday
- T: Thursday
- F: Friday
- S: Saturday
- S: Sunday

Uppercase letters indicate a specific day of the week. A "-" indicates no selection for the day of the week. Each character is displayed in the order of the days of the week. Saturday and Sunday are distinguished by its position.

## On-/Off-times

Any time between 00:00 h and 23:59 h is possible. You can also configure the on time to be a pulse signal. The timer block will be activated at the specified time for one cycle and then the output is reset.

-:- means: No on-/off-times set.



### Setting the seven-day time switch

To set the on-/off-times:

1. Move the cursor to one of the Cam parameters of the timer (for example, No1).
2. Press **OK**. The cursor is positioned on the day of the week.
3. Press **▲** and **▼** to select one or several days of the week.
4. Press **▶** to move the cursor to the first position of the on-time.
5. Set the on-time.  
 Modify the value at the respective position, using the keys **▲** and **▼**. Move to the cursor to the various positions, using the keys **◀** and **▶**. At the first position, you can only select the value - :- -  
 (- :- - means: No on-/off-times set).
6. Press **▶** to move the cursor to the first position of the off-time.
7. Set the off-time (in same way as in Step 5).
8. Confirm your entries with **OK**.

To configure Cam2, press **▶**. The cursor is now positioned on the No2 parameter (Cam2) and you can continue with Steps 1 to 8.

---

#### Note

For information on timer accuracy, refer to the technical data and to the topic "Time response (Page 126)".

---

### Seven-day time switch: Example

The output of the seven-day time switch is to be set daily from 06:30 h to 08:00 h. The output should also be set every Tuesday from 03:10 h to 04:15 h, and on the weekends from 16:30 h to 23:10 h.

This requires three cams.

Here are the parameter assignment screen forms of the cams No 1, 2 and 3, based on the timing diagram shown earlier.

- Cam No1 must set the output of the seven-day time switch daily from 06:30 h to 08:00 h.
- Cam No2 must set the output of the seven-day time switch every Tuesday from 03:10 h to 04:15 h.
- Cam No3 must set the output of the seven-day time switch every Saturday and Sunday from 16:30 h to 23:10 h.

Views in IDEC SmartRelay:

B1	1/2
D1	=MTWTFSS
On1	=06:30
Off1	=08:00
D2	=-T-----
On2	=03:10

B1	2/2
Off2	=04:15
D3	=-----SS
On3	=16:30
Off3	=23:10
Pulse	=Off

**Result**

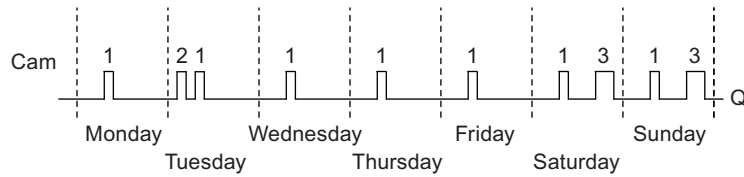

**4.4.12 Twelve-month time switch**

**Short description**

The output is controlled by means of a configurable on/off date. You can configure the timer to activate on a yearly, monthly, or user-defined time basis. With any mode, you can also configure the timer to pulse the output during the defined time period. The time period is configurable within the date range of January 1, 2000 to December 31, 2099.

Symbol in IDEC SmartRelay	Wiring	Description
<p>12-Month Switch</p>	Cam parameter	At the Cam parameter, you configure the timer mode, the on-/off-times for the timer, and whether the output is a pulse output.
	Output Q	IDEC SmartRelay sets Q when the configured cam is on.

**Timing diagrams**

**Example 1:** Yearly mode on, Monthly mode off, Pulse Off, On Time = 2000-06-01, Off Time = 2099-08-31: every year on June 1 the timer output switches on and remains on until August 31.

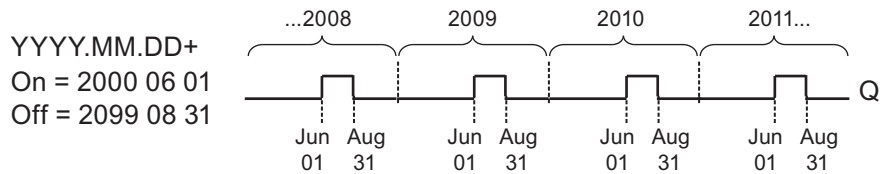

B6	1/3
Yearly	=On
Monthly	=Off
Pulse	=Off

B6	2/3
On Date	YYYY-MM-DD
	2000-06-01

B6	3/3
Off Date	YYYY-MM-DD
	2099-08-31

**Example 2:** Yearly mode on, Monthly mode off, Pulse on, On Time = 2000-03-15, Off Time = 2099-\*\*-\*\*: every year on March 15, the timer switches on for one cycle.

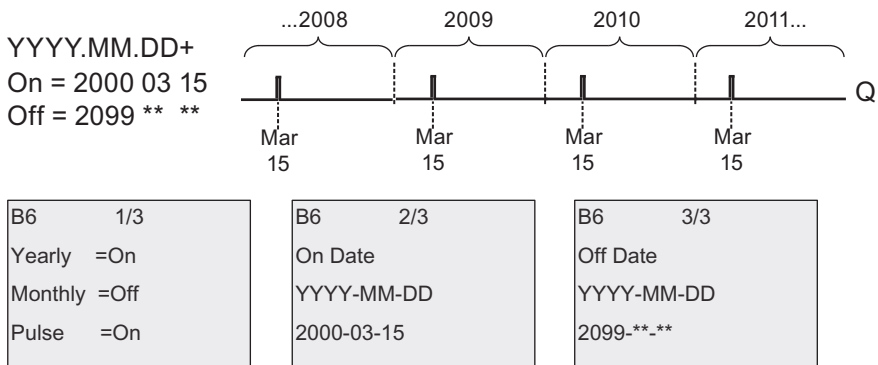

**Example 3:** Yearly mode on, Monthly mode off, Pulse off, On Time = 2008-06-01, Off Time = 2010-08-31: on June 1 of 2008, 2009, and 2010 the timer output switches on and remains on until August 31.

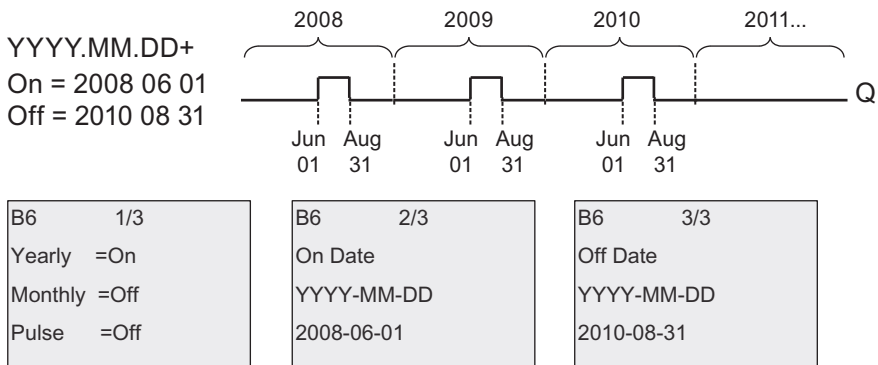

**Example 4:** Yearly mode on, Monthly mode off, Pulse on, On Time = 2008-03-15, Off Time = 2010-\*\*-\*\*: on March 15 of 2008, 2009, and 2010, the timer output switches on for one cycle.

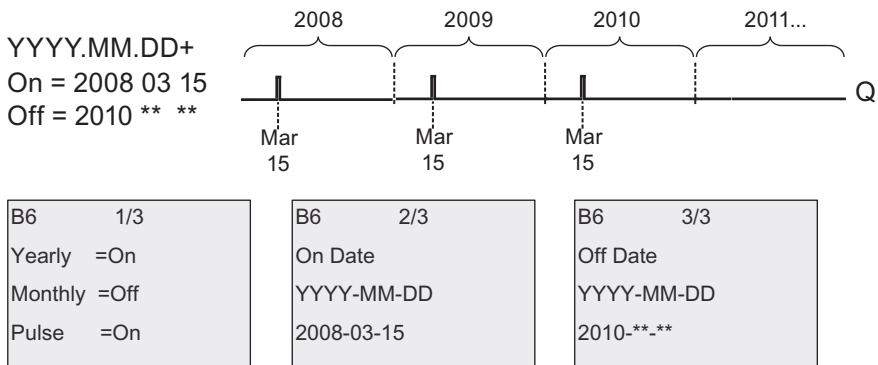

**Example 5:** Yearly mode off, Monthly mode off, Pulse off, On Time = 2008-06-01, Off Time = 2010-08-31: on June 1, 2008 the timer output switches on and remains on until August 31, 2010.

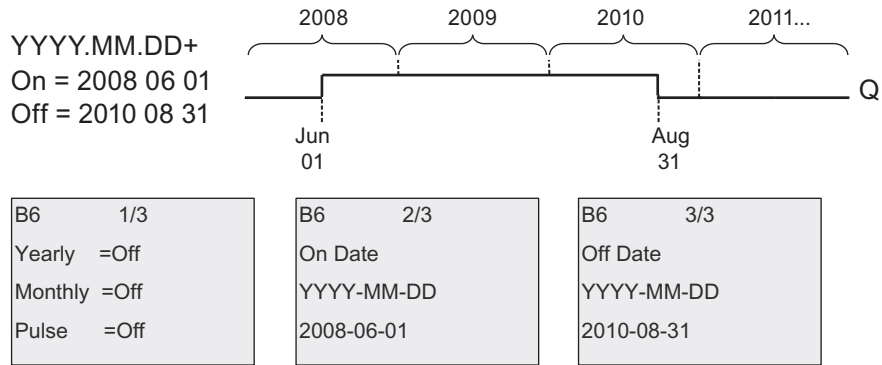

**Example 6:** Yearly mode off, Monthly mode off, Pulse selected, On Time = 2008-03-15, Off Time = \*\*\*\*\_\*\*\_\*\*: on March 15, 2008 the timer output switches on for one cycle. Because the timer does not have a monthly action or yearly action, the timer output pulses only one time at the specified On Time.

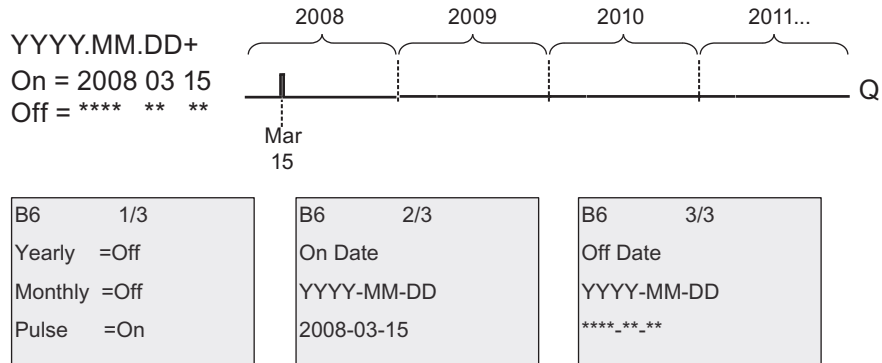

**Example 7:** Yearly mode on, Monthly mode off, Pulse off, On Time = 2008-12-15, Off Time = 2010-01-07: on December 15 of 2008 and 2009, the timer output switches on and remains on until January 7 of the following year. When the timer output turns off on January 7, 2010 it does NOT turn on again the following December 15.

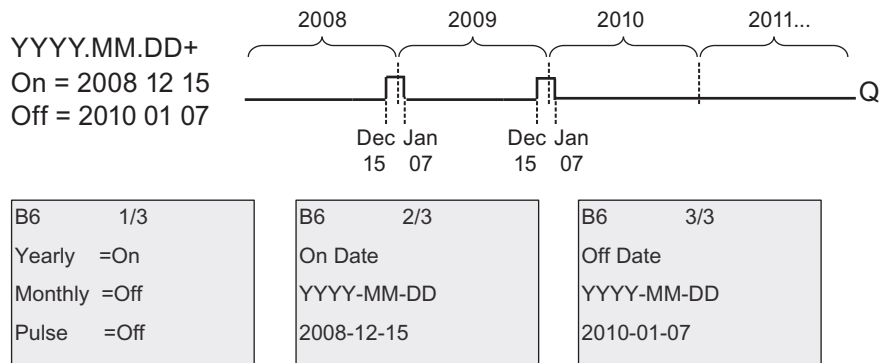

**Example 8:** Yearly mode on, Monthly mode on, On Time = 2008-\*\*-01, Off Time = 2010-\*\*-05: starting in 2008, on the first day of each month the timer output switches on and switches off on the fifth day of the month. The timer continues in this pattern through the last month of 2010.

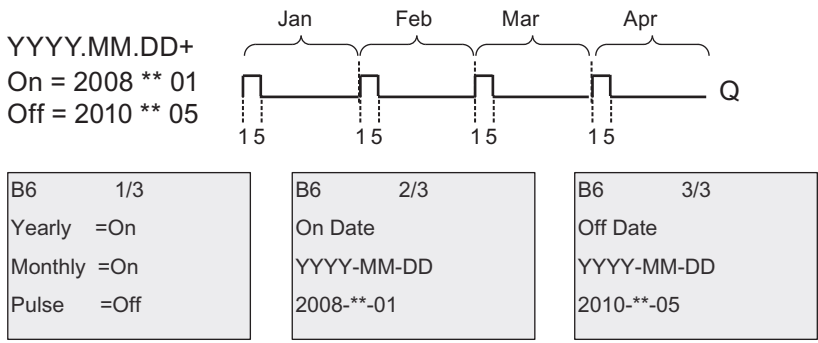

### Functional description

The twelve-month time switch sets and resets the output at specific on and off dates. Sets and resets are executed at 00:00. If your application requires a different time, use a seven-day time switch together with a twelve-month time switch in your circuit program.

The on time specifies when the timer is activated. The off time specifies when the output is reset again. For the on and off times, note the order of the fields: The first field defines the year, the second the month and the third the day.

If you set the Monthly mode on, the timer output switches on each month at the specified day of the on time and remains on until the specified day of the off time. The on time specifies the initial year in which the timer is activated. The off time defines the last year in which the timer turns off. The maximum year is 2099.

If you set the Yearly mode on, the timer output switches on each year at the specified month and day of the on time and remains on until the specified month and day of the off time. The on time specifies the initial year in which the timer is activated. The off time defines the last year in which the timer turns off. The maximum year is 2099.

If you set Pulse output, the timer output switches on at the specified on time for one cycle and then the timer output is reset. You can choose to pulse a timer on a monthly or yearly basis, or just a single time.

If you set none of the Monthly, Yearly, or Pulse modes on, you can define a specific time period with the on time and off time. It can span any time period that you choose.

For a process action that is to be switched on and off at multiple but irregular times during the year, you can define multiple twelve-month time switch with the outputs connected by an OR function block.

## Backup of the real-time clock

The internal real-time clock of IDEC SmartRelay is buffered against power failure. The buffering time is influenced by the surrounding temperature, and is typically 80 hours at a surrounding temperature of 25°C.

## Sample configuration

The output of an IDEC SmartRelay is to be set annually on March 1, reset on April 4, set again on July 7, and reset again on November 19. You need to configure two twelve-month time switches with corresponding on-times, then logically link the outputs by means of an OR block.

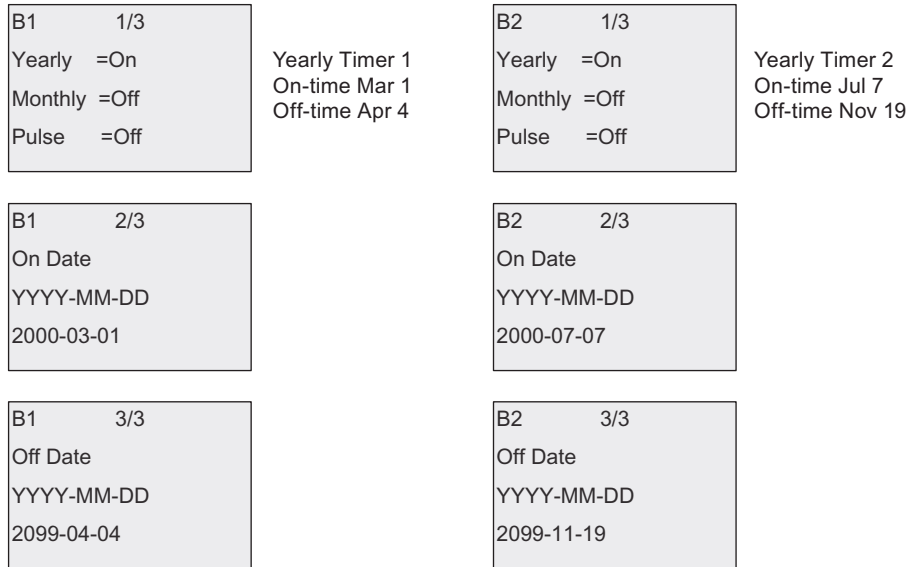

## Result

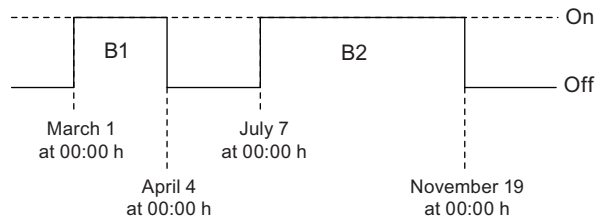

### 4.4.13 Astronomical clock

#### Short description

The astronomical clock function is used to set an output high when the current time of your IDEC SmartRelay Base Module is between the time of sunrise (TR) and the time of sunset (TS). IDEC SmartRelay automatically calculates these times based on the geographical location, the settings for automatic summertime/wintertime conversion, and the current time of the module.

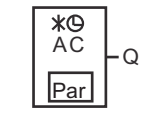
Symbol in IDEC SmartRelay	Wiring	Description
 <p>Astron. Clock</p>	Parameter	You specify the longitude, latitude, time zone, sunrise time offset and sunset time offset: <b>Longitude:</b> Direction settings: EAST or WEST Range of values: 0 ° to 180 ° (degrees) 0 ' to 59 ' (minutes) 0 " to 59 " (seconds) <b>Latitude:</b> Direction settings: NORTH or SOUTH Range of values: 0 ° to 90 ° (degrees) 0 ' to 59 ' (minutes) 0 " to 59 "(seconds) <b>Zone:</b> Range of values: -11 to 12 <b>TR Offset</b> (sunrise time offset): Range of values: -59 minutes to 59 minutes <b>TS Offset</b> (sunset time offset): Range of values: -59 minutes to 59 minutes
	Output Q	IDEC SmartRelay sets Q to "1" when the current time of your IDEC SmartRelay Base Module is between the sunrise time (TR) and the sunset time (TS).

#### Note

From WindLGC V8.0, you can choose from several pre-defined time zone locations. If you select one of these locations, WindLGC uses the latitude, longitude, and the time zone of your selection. This location pre-configuration capability is only possible from WindLGC.

## Timing diagram

The following illustration is an example of the timing diagram where Ta refers to the current time of the IDEC SmartRelay Base Module:

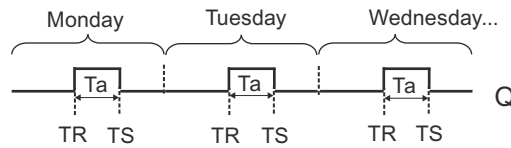

## Functional description

The function calculates the TR and TS values at the input and sets Q when Ta (Ta is the current IDEC SmartRelay Time) is between TR and TS; otherwise, the function resets Q.

If automatic summertime/wintertime conversion (see the topic Summertime/wintertime conversion (Page 90) for details) is enabled, the function takes the configured time difference into consideration when calculating the TR and TS values.

## Setting the Par parameter

View in programming mode (example):

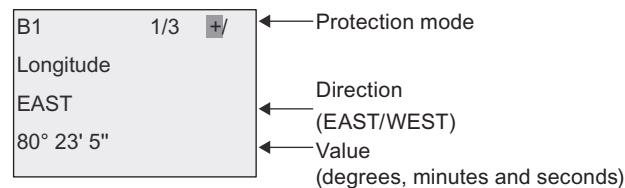

Press ►

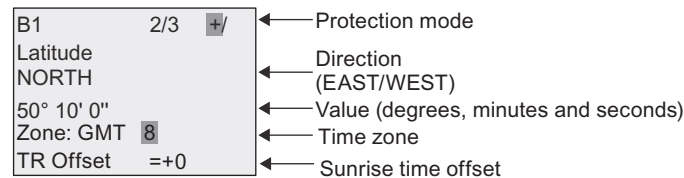

Press ►

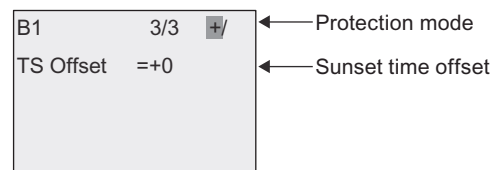



View in parameter assignment mode (example):

B1	1/3
Longitude	
EAST	
80° 23' 5"	

Press ▼

B1	2/3
Latitude	
NORTH	
50° 10' 0"	
Zone: GMT	8
TR Offset	=+0

If automatic summertime/wintertime conversion is disabled, press ▼ and IDEC SmartRelay shows the following view in parameter assignment mode (example):

B1	3/3	
TR Offset	=+0	
TR	=10:38	← Sunrise time
TS	=18:46	← Sunset time

If automatic summertime/wintertime conversion is enabled and set to "EU" (for example), press ▼ and IDEC SmartRelay shows the following view in parameter assignment mode (example):

B1	3/3
TR Offset	=+0
TR	=11:38
TS	=19:46

## 4.4.14 Stopwatch

### Short description

The stopwatch function counts the elapsed time between a start stopwatch signal and a stop stopwatch signal.

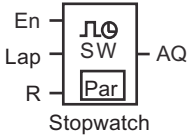
Symbol in IDEC SmartRelay	Wiring	Description
	En	A signal at input En begins counting elapsed time at analog output AQ.
	Lap	A positive edge (0 to 1 transition) at input Lap pauses the stopwatch. A negative edge (1 to 0 transition) at input Lap resumes the stopwatch.
	R	A signal at input R resets the elapsed time.
	Parameter	You can set a timebase <b>TB</b> for the stopwatch. <b>Possible timebase settings:</b> 10 ms, s, m, and h Retentivity: / = No retentivity R = The status is retentive
	Output AQ	A signal at input Lap holds the value of AQ until Lap is reset to 0. A signal at input R resets the value of AQ to 0.

### Parameters TB

You can set a timebase from the following timebase set:

- 10 ms (10 milliseconds)
- s (seconds)
- m (minutes)
- h (hours)

**Timing diagram**

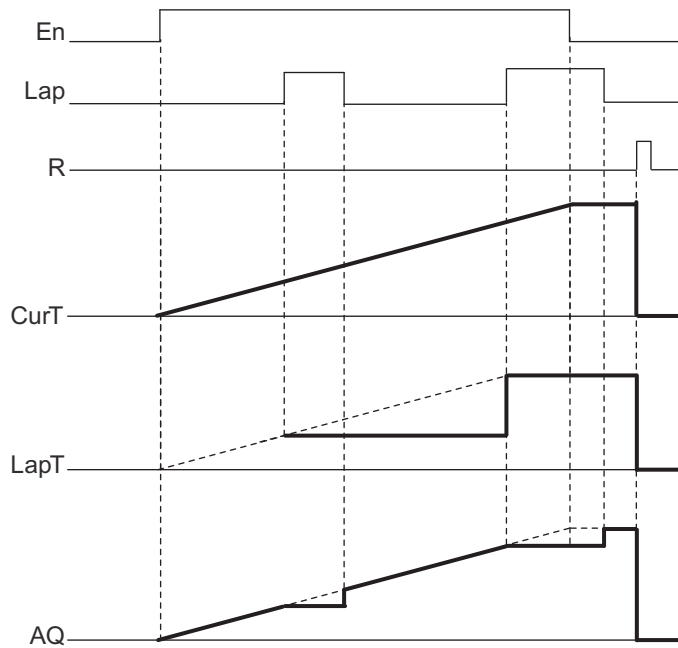

**Functional description**

En = 1 and Lap = 0: Using the selected timebase, the stopwatch outputs the current time (CurT) to AQ.

En = 1 and Lap = 1: The stopwatch leaves AQ at its last value when Lap = 0. This value is recorded as LapT for stopwatch pause time.

En = 0 and Lap = 1: The stopwatch pauses counting time. It outputs LapT to AQ.

En = 0 and Lap = 0: The stopwatch outputs the current time (CurT) to AQ.

A signal at R sets the AQ value to 0.

**Setting the Par parameter**

View in programming mode (example):

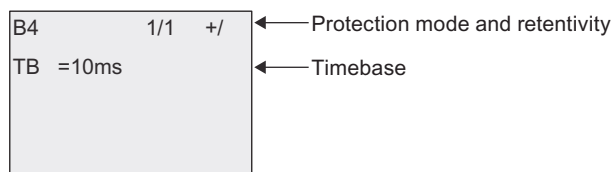

To change the timebase, press ► to move the cursor to "10ms". Press **OK** and now the timebase can be selected. Press ▲ or ▼ to select another timebase. To confirm your selection, press **OK**.

View in parameter assignment mode (example):

B4	1/1	
TB	=10ms	
CurT	=5:3:2:8	← Current elapsed time recorded
LapT	=4:3:5:6	← Stopwatch pause time
OutT	=4:3:5:6	← AQ value

## 4.4.15 Up/down counter

### Short description

An input pulse increments or decrements an internal value, depending on the parameter setting. The output is set or reset when a configured threshold is reached. The direction of count can be changed with a signal at input Dir.

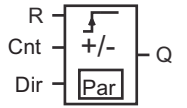
Symbol in IDEC SmartRelay	Wiring	Description
 <p>Up/Down Counter</p>	Input R	A signal at input R resets the internal count value to zero.
	Input Cnt	<p>The function counts the 0 to 1 transitions at input Cnt. 1 to 0 transitions are not counted.</p> <p>You can use the following as the input:</p> <ul style="list-style-type: none"> <li>inputs I3, I4, I5, and I6 for fast counting (only FL1F-H12RCE/B12RCE and FL1F-H12SCD): max. 5 kHz, if the fast input is directly connected to the up/down counter function block</li> <li>any other input or circuit component for counting low frequency signals (typically 4 Hz)</li> </ul>
	Input Dir	<p>You set the direction of count at input Dir:</p> <p>Dir = 0: Count up Dir = 1: Count down</p>
	Parameter	<p>On: on threshold Range of values: 0...999999</p> <p>Off: off threshold Range of values: 0...999999</p> <p>StartVal: initial value from which to begin counting either down or up.</p> <p>Retentivity for internal counter value Cnt: / = No retentivity R = The status is retentive.</p>
	Output Q	Q is set or reset, depending on the current value at Cnt and the set thresholds.

### Parameters On and Off

The actual value of another already-programmed function can provide the on threshold On and the off threshold Off. You can use the actual values of the following functions:

- Analog comparator (Page 184) (actual value Ax – Ay)
- Analog trigger (Page 179) (actual value Ax)
- Analog amplifier (Page 192) (actual value Ax)
- Analog multiplexer (Page 210) (actual value AQ)
- Analog ramp control (Page 213) (actual value AQ)
- Analog Math (Page 225) (actual value AQ)
- PI controller (Page 217) (actual value AQ)
- Up/down counter (actual value Cnt)
- Analog filter (Page 230) (actual value AQ)
- Average value (Page 236) (actual value AQ)
- Max/Min (Page 232) (actual value AQ)
- On-delay (Page 134) (current time Ta)
- Off-delay (Page 137) (current time Ta)
- On-/off-delay (Page 139) (current time Ta)
- Retentive on-delay (Page 141) (current time Ta)
- Interval time-delay relay/Pulse output (Page 143) (current time Ta)
- Edge-triggered interval time-delay relay (Page 145) (current time Ta)
- Asynchronous pulse generator (Page 147) (current time Ta)
- Stairwell light switch (Page 151) (current time Ta)
- Dual-function switch (Page 153) (current time Ta)
- Stopwatch (Page 167) (actual value AQ)
- Frequency trigger (Page 176) (actual value Fre)

Select the required function by the block number.

### Timing diagram

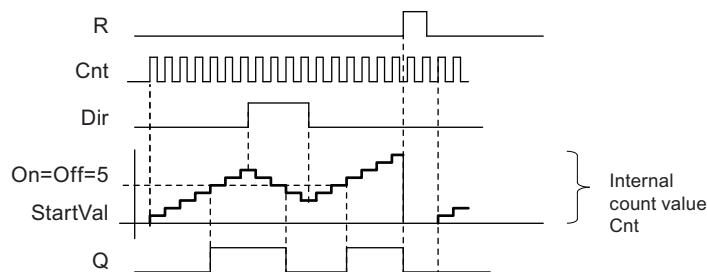

### Functional description

The internal counter increments (Dir = 0) or decrements (Dir = 1) by one count with every positive edge at input Cnt.

You can use input R to reset the internal count value to the start value. As long as R = 1, the output is also 0 and the pulses at input Cnt are not counted.

If retentivity is not set, output Q and the expired time are reset after a power failure.

Q is set or reset depending on the current value at Cnt and the set thresholds. See the calculation rule below.

### Calculation rule

- If the On threshold  $\geq$  Off threshold, then:  
 $Q = 1$ , if  $Cnt \geq On$   
 $Q = 0$ , if  $Cnt < Off$
- If the On threshold  $<$  Off threshold, then  $Q = 1$ , if  $On \leq Cnt < Off$ .

#### Note

The system scans the counter limit value cyclically.

Thus, if the pulse frequency at the fast digital inputs I3, I4, I5 or I6 is faster than the cycle time, the special function might not switch until after the specified limit value is exceeded.

Example: Up to 100 pulses per cycle can be counted; 900 pulses have been counted so far. On = 950; Off = 10000. The output is set in the next cycle, after the value has reached 1000. (The output would not be set at all if the value Off = 980).

View in programming mode (example):

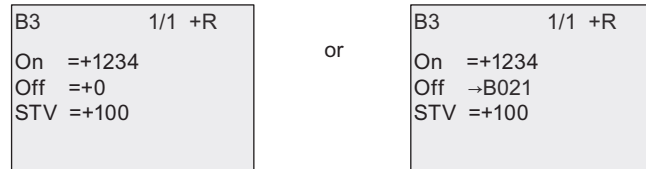

If the referenced block (B021, in the example) returns a value that lies out of the valid range, the value is rounded to the next valid value.

The view in parameter assignment mode (example):

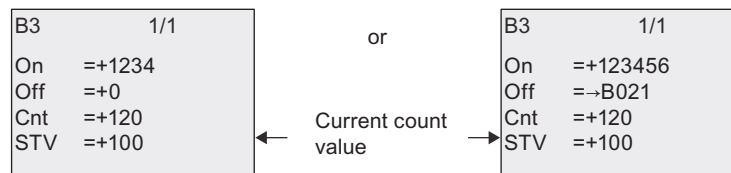

### 4.4.16 Operating hours counter

#### Short description

A configured time is triggered with a signal at the monitoring input. The output is set when this time has expired.

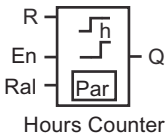
Symbol in IEEC SmartRelay	Wiring	Description
 <p>Hours Counter</p>	Input R	A positive edge (0 to 1 transition) at input R resets output Q and sets a configured value MI at the counter for the duration of the time-to-go (MN).
	Input En	En is the monitoring input. IEEC SmartRelay scans the on-time of this input.
	Input Ral	A positive edge at input Ral (Reset all) resets the operating hours counter (OT) and the output, and sets the time-to-go value (MN) to the maintenance interval MI: <ul style="list-style-type: none"> <li>• Output Q = 0</li> <li>• Measured operating time OT = 0</li> <li>• Time-to-go of the maintenance interval MN = MI.</li> </ul>
	Parameter	MI: Maintenance interval to be preset in units of hours and minutes Range of values: 0000 h to 9999 h, 0 m to 59 m OT: the accumulated total operating time (you can specify an offset in hours and minute) Range of values: 00000 h to 99999 h, 0 m to 59 m Q → 0 occurs depending on the following conditions: <ul style="list-style-type: none"> <li>• When "R" is selected:                              Q = 1, if MN = 0;                              Q = 0, if R = 1 or Ral = 1</li> <li>• When "R+En" is selected:                              Q = 1, if MN = 0;                              Q = 0, if R = 1 or Ral = 1 or En = 0.</li> </ul>
	Output Q	The output is set when the time-to-go MN = 0 (see timing diagram). The output is reset under the following conditions: <ul style="list-style-type: none"> <li>• When "Q → 0:R+En", if                              R = 1 or Ral = 1 or En = 0</li> <li>• When "Q → 0:R", if R = 1 or Ral = 1.</li> </ul>

**Note**

MI, MN and OT are always retentive.

## Parameter MI

The maintenance interval MI can be provided by the actual value of another already-programmed function. The timebase of the referenced value is "h" (for hours) only. You can use the actual values of the following functions:

- Analog comparator (Page 184) (actual value Ax – Ay)
- Analog trigger (Page 179) (actual value Ax)
- Analog amplifier (Page 192) (actual value Ax)
- Analog multiplexer (Page 210) (actual value AQ)
- Analog ramp control (Page 213) (actual value AQ)
- Analog Math (Page 225) (actual value AQ)
- PI controller (Page 217) (actual value AQ)
- Up/down counter (Page 169) (actual value Cnt)
- Analog filter (Page 230) (actual value AQ)
- Average value (Page 236) (actual value AQ)
- Max/Min (Page 232) (actual value AQ)
- On-delay (Page 134) (current time Ta)
- Off-delay (Page 137) (current time Ta)
- On-/off-delay (Page 139) (current time Ta)
- Retentive on-delay (Page 141) (current time Ta)
- Interval time-delay relay/Pulse output (Page 143) (current time Ta)
- Edge-triggered interval time-delay relay (Page 145) (current time Ta)
- Asynchronous pulse generator (Page 147) (current time Ta)
- Stairwell light switch (Page 151) (current time Ta)
- Dual-function switch (Page 153) (current time Ta)
- Stopwatch (Page 167) (current time Ta)

Select the required function by the block number.



### Timing diagram

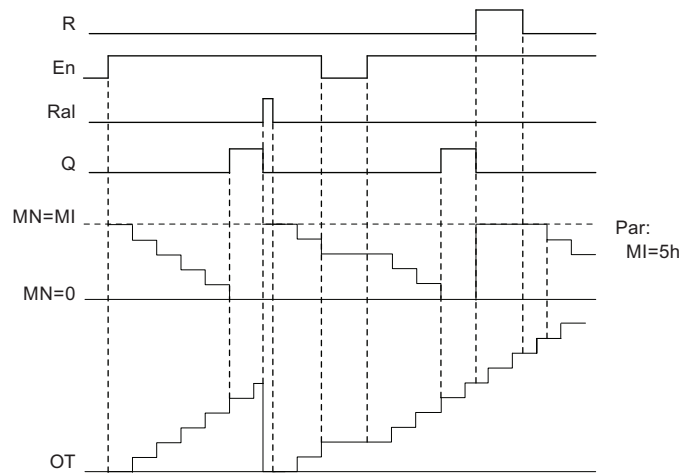

MI = Configured time interval  
 MN = Time-to-go  
 OT = Total time expired since the last hi signal at input Ral

### Functional description

The operating hours counter monitors input En. When En = 1, IDEC SmartRelay computes the time expired and the time-to-go MN. IDEC SmartRelay shows these times in parameter assignment mode. Output Q is set when the time-to-go MN = 0.

A signal at reset input R resets output Q and sets the preset value of MI at the counter for the duration of MN. The operating hours counter OT is not affected.

With a signal at the reset input Ral, you reset output Q and set the preset value of MI at the counter for the duration of MN. The operating hours counter OT is reset to zero.

Depending on your configuration of parameter Q, the output is either reset with a signal at input R or Ral ("Q → 0:R"), or when a reset signal is set hi, or the En signal is set lo ("Q → 0:R+En").

### Viewing the MI, MN and OT values

- IDEC SmartRelay Basic: You can open the parameter assignment mode when the system is in RUN to view the actual values of MI, MN and OT.
- IDEC SmartRelay Pure: In WindLGC, you can use the Online Test to read these values. For further information, see chapter "IEEC SmartRelay software (Page 287)".
- In WindLGC you can get the operating hours counter via the "Tools -> Transfer: Hours counter" menu command.

## Limit value of OT

The value of the operating hours in OT is retained when you reset the operating hours counter with a signal at input R. The operating hours counter OT will be reset to zero with a transition from 0 to 1 at Ral. It continues the count as long as En = 1, irrespective of the status at the reset input R. The counter limit of OT is 99999 h. The operating hours counter stops when it reaches this value.

In programming mode, you can set the initial value of OT. MN is calculated according to the following formula when reset input R is never enabled:  $MN = MI - (OT \% MI)$ . The % operator provides an integer division remainder.

Example:

MI = 30h, OT = 100h

$MN = 30 - (100 \% 30)$

$MN = 30 - 10$

$MN = 20h$

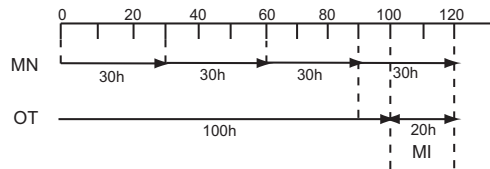

In runtime mode, the value OT can not be preset. If the value for MI is changed, there would be no calculation for the MN. MN would take on the value of MI.

## Setting the Par parameter

View in programming mode:

B16	1/1	+/
MI	=100h:0m	
OT	=30h:0m	
Q→0:	=R+En	

B16	1/1	+/
MI	→B001 h	
OT	=30h:0m	
Q→0:	=R+En	

**MI** is the configurable time interval. The permissible range of values is 0 to 9999 hours.

For information on how to assign the actual value of another already-programmed function to a parameter, see the On-delay (Page 134) topic.

View in parameter assignment mode:

B16	1/1	
MI	=100h:0m	← Time interval
OT	=83h:15m	← Total operating hours
MN	=16h:45m	← Time-to-go

### 4.4.17 Frequency trigger

#### Short description

The output is set and reset with two configurable frequency trigger.

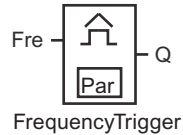
Symbol in IDEC SmartRelay	Wiring	Description
 <p>FrequencyTrigger</p>	Input Fre	The function counts the 0 to 1 transitions at input Fre. 1 to 0 transitions are not counted. Use the following as the input: <ul style="list-style-type: none"> <li>inputs I3, I4, I5, I6 for fast counting (only FL1F-H12RCE/B12RCE and FL1F-H12SCD): max. 5 kHz, if the fast input is directly connected to the frequency trigger function block</li> <li>any other input or circuit component for counting low frequency signals (typically 4 Hz)</li> </ul>
	Parameter	On: on threshold Range of values: 0000...9999 Off: off threshold Range of values: 0000...9999 G_T: time interval or gate time during which the input pulses are measured Range of values: 00:00 s...99:99 s
	Output Q	Q is set and reset at the thresholds.

#### Parameter G\_T

The gate time G\_T can be provided by the actual value of another already-programmed function. You can use the actual values of the following functions:

- Analog comparator (Page 184) (actual value Ax – Ay)
- Analog trigger (Page 179) (actual value Ax)
- Analog amplifier (Page 192) (actual value Ax)
- Analog multiplexer (Page 210) (actual value AQ)
- Analog ramp control (Page 213) (actual value AQ)
- Analog Math (Page 225) (actual value AQ)
- PI controller (Page 217) (actual value AQ)
- Up/down counter (Page 169) (actual value Cnt)
- Analog filter (Page 230) (actual value AQ)
- Average value (Page 236) (actual value AQ)
- Max/Min (Page 232) (actual value AQ)
- On-delay (Page 134) (current time Ta)
- Off-delay (Page 137) (current time Ta)
- On-/off-delay (Page 139) (current time Ta)

- Retentive on-delay (Page 141) (current time Ta)
- Interval time-delay relay/Pulse output (Page 143) (current time Ta)
- Edge-triggered interval time-delay relay (Page 145) (current time Ta)
- Asynchronous pulse generator (Page 147) (current time Ta)
- Stairwell light switch (Page 151) (current time Ta)
- Dual-function switch (Page 153) (current time Ta)
- Stopwatch (Page 167) (actual value AQ)
- Frequency trigger (Page 176) (actual value Fre)

Select the required function by the block number.

### Timing diagram

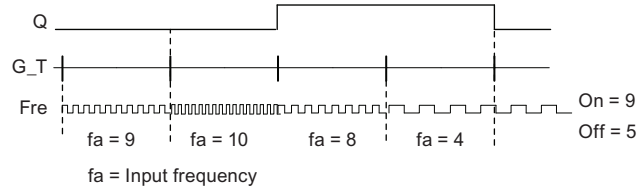

### Functional description

The frequency trigger measures the signals at input Fre. The pulses are recorded across a configurable time G\_T.

Output Q is set and reset in accordance with the set thresholds. See the calculation rule below.

### Calculation rule

- If the On threshold  $\geq$  Off threshold, then  $Q = 1$ , if  $f_a > \text{On}$  or  $Q = 0$ , if  $f_a \leq \text{Off}$ .
- If the On threshold  $<$  Off threshold, then  $Q = 1$  if  $\text{On} \leq f_a < \text{Off}$ .

### Setting the Par parameter

---

**Note**

The system scans the counter limit value once per interval G\_T.

---

View in programming mode (example):

B15	1/1	+/	← Parameter protection mode
On	=9		← On threshold
Off	=5		← Off threshold
G_T	=01:00s		← Time interval for pulses (example)

---

**Note**

The "seconds" timebase is here set as permanent default.

When you preset a time G\_T of 1 s, IDEC SmartRelay returns the current frequency in parameter  $f_a$  in Hz.

---

View in parameter assignment mode (example):

B15	1/1		
On	=9		← On threshold
Off	=5		← Off threshold
fa	=10		← $Q = 1 (f_a > On)$

---

**Note**

$f_a$  always represents the total pulses measured per time unit G\_T.

---

## 4.4.18 Analog trigger

### Short description

The output is set and reset at two configurable thresholds.

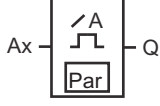
Symbol in IDEC SmartRelay	Wiring	Description
 <p>Symbol description: A rectangular box containing a triangle with the letter 'A' above it, and the word 'Par' below it. To the right of the box is the letter 'Q'. To the left of the box is the label 'Ax'. Below the box is the text 'Analog Trigger'.</p>	Input Ax	Input Ax is one of the following analog signals: <ul style="list-style-type: none"> <li>• AI1 to AI8 (*)</li> <li>• AM1 to AM64</li> <li>• NAI1 to NAI32</li> <li>• AQ1 to AQ8</li> <li>• NAQ1 to NAQ16</li> <li>• Block number of a function with analog output</li> </ul>
	Parameter	A: gain Range of values: -10.00 to 10.00 B: zero offset Range of values: -10,000 to 10,000 On: on threshold Range of values: -20,000 to 20,000 Off: off threshold Range of values: -20,000 to 20,000 p: number of decimals Range of values: 0, 1, 2, 3
	Output Q	Q is set or reset by the thresholds.
* AI1...AI8: 0...10 V corresponds with 0...1000 (internal value).		

### Gain and offset parameters

Please note the information on gain and offset parameters in topic "Calculating the gain and offset of analog values (Page 128)".

### Parameters On and Off

The actual value of another already-programmed function can provide the On and Off parameters. You can use the actual values of the following functions:

- Analog comparator (Page 184) (actual value Ax – Ay)
- Analog amplifier (Page 192) (actual value Ax)
- Analog multiplexer (Page 210) (actual value AQ)
- Analog ramp control (Page 213) (actual value AQ)
- Analog Math (Page 225) (actual value AQ)
- PI controller (Page 217) (actual value AQ)
- Up/down counter (Page 169) (actual value Cnt)
- Analog filter (Page 230) (actual value AQ)
- Average value (Page 236) (actual value AQ)
- Max/Min (Page 232) (actual value AQ)

- On-delay (Page 134) (current time Ta)
- Off-delay (Page 137) (current time Ta)
- On-/off-delay (Page 139) (current time Ta)
- Retentive on-delay (Page 141) (current time Ta)
- Interval time-delay relay/Pulse output (Page 143) (current time Ta)
- Edge-triggered interval time-delay relay (Page 145) (current time Ta)
- Asynchronous pulse generator (Page 147) (current time Ta)
- Stairwell light switch (Page 151) (current time Ta)
- Dual-function switch (Page 153) (current time Ta)
- Stopwatch (Page 167) (actual value AQ)
- Analog trigger (Page 179) (actual value Ax)
- Frequency trigger (Page 176) (actual value Fre)

Select the required function by the block number.

### Parameter p (number of decimals)

Applies only to the display of On, Off and Ax values in a message text.  
Does not apply to the comparison of On and Off values. (The compare function ignores the decimal point.)

### Timing diagram

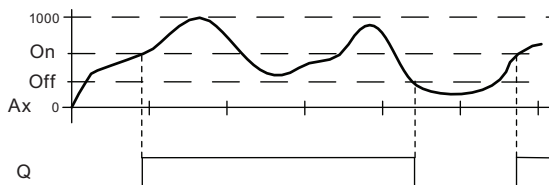

### Functional description

The function fetches the analog signal at input Ax.

Ax is multiplied by the value of the A (gain) parameter, and the value at parameter B (offset) is added to product, i.e.  $(Ax \cdot \text{gain}) + \text{offset} = \text{actual value of Ax}$ .

Output Q is set or reset, depending on the set thresholds. See the calculation rule below.

### Calculation rule

- If the On threshold  $\geq$  Off threshold, then  $Q = 1$ , if the actual value  $A_x > \text{On}$  or  $Q = 0$ , if the actual value  $A_x \leq \text{Off}$ .
- If the On threshold  $<$  Off threshold, then  $Q = 1$  if  $\text{On} \leq \text{actual value } A_x < \text{Off}$ .

### Setting the Par parameter

The gain and offset parameters are used to adapt the sensors to the relevant application.

View in programming mode (example):

B3	1/1	+/	← Parameter protection mode
On	=+4000		← On threshold
Off	=+2000		← Off threshold
A	=+1.00		← Gain
B	=+0		← Offset
P	=2		← Decimals in the message text

View in parameter assignment mode (example):

B3	1/1		
On	=+4000		← On threshold
Off	=+2000		← Off threshold
Ax	=+0		← $Q = 1 (A_x > \text{On})$

View in the message text (example):

+050.00	← $A_x$ , when $p = 2$ $Q = 1 (A_x > \text{On})$
---------	---



### 4.4.19 Analog differential trigger

#### Short description

The output is set and reset depending on a configurable threshold and a differential value.

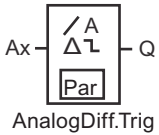
Symbol in IDEC SmartRelay	Wiring	Description
	Input Ax	Input Ax is one of the following analog signals: <ul style="list-style-type: none"> <li>• AI1 to AI8 (*)</li> <li>• AM1 to AM64</li> <li>• NAI1 to NAI32</li> <li>• AQ1 to AQ8</li> <li>• NAQ1 to NAQ16</li> <li>• Block number of a function with analog output</li> </ul>
	Parameter	A: gain Range of values: -10.00 to 10.00 B: zero offset Range of values: -10,000 to 10,000 On: On/Off threshold Range of values: -20,000 to 20,000 Δ: differential value for calculating the off parameter Range of values: -20,000 to 20,000 p: Number of decimals Range of values: 0, 1, 2, 3
	Output Q	Q is set or reset, depending on the threshold and difference values.

\* AI1...AI8: 0...10 V corresponds with 0...1000 (internal value).

#### Gain and offset parameters

Please note the information on gain and offset parameters in topic "Calculating the gain and offset of analog values (Page 128)".

#### Parameter p (number of decimals)

Applies only to the display of On, Off and Ax values in a message text.

#### Timing diagram A: Function with negative difference Δ

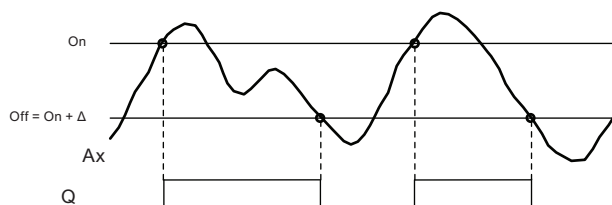

### Timing diagram B: Function with positive difference $\Delta$

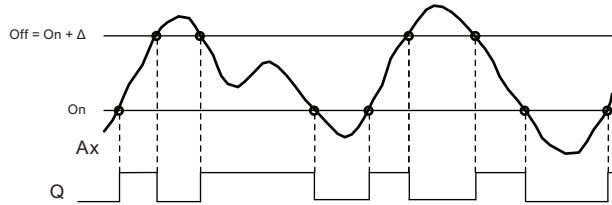

### Functional description

The function fetches the analog signal at input  $A_x$ .

$A_x$  is multiplied by the value of the A (gain) parameter, and the value at parameter B (offset) is added to product, i.e.  $(A_x \cdot gain) + offset = actual\ value\ of\ A_x$ .

Output  $Q$  is set or reset, depending on the set (On) threshold and difference value ( $\Delta$ ). The function automatically calculates the Off parameter:  $Off = On + \Delta$ , whereby  $\Delta$  may be positive or negative. See the calculation rule below.

### Calculation rule

- When you set a negative differential value  $\Delta$ , the On threshold  $\geq$  Off threshold, and  $Q = 1$  if the actual value  $A_x > On$  or  $Q = 0$  if the actual value  $A_x \leq Off$ .  
See the timing diagram A.
- When you set a positive differential value  $\Delta$ , the On threshold  $<$  the Off threshold, and  $Q = 1$ , if  $On \leq actual\ value\ A_x < Off$ .  
See the timing diagram B.

### Setting the Par parameter

The gain and offset parameters are used to adapt the sensors to the relevant application.

View in programming mode (example):

B3	1/1 +/	← Parameter protection mode
On	=+4000	← On/off threshold
$\Delta$	=-2000	← Differential value for the on/off threshold
A	=+1.00	← Gain
B	=+0	← Offset
P	=2	← Decimals in the message text

View in parameter assignment mode (example):

B3	1/1	
On	=+4000	← On threshold
$\Delta$	=-2000	← Differential value for the off threshold
Off	=+2000	← Off threshold
$A_x$	=+5000	← $Q = 1 (A_x > On)$

### 4.4.20 Analog comparator

#### Short description

The output is set and reset depending on the difference  $A_x - A_y$  and on two configurable thresholds.

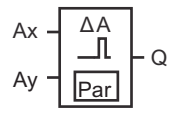
Symbol in IEEC SmartRelay	Wiring	Description
 <p>AnalogComparator</p>	Inputs Ax and Ay	Inputs Ax and Ay are one of the following analog signals: <ul style="list-style-type: none"> <li>• AI1 to AI8 (*)</li> <li>• AM1 to AM64</li> <li>• NAI1 to NAI32</li> <li>• AQ1 to AQ8</li> <li>• NAQ1 to NAQ16</li> <li>• Block number of a function with analog output</li> </ul>
	Parameter	A: gain Range of values: -10.00 to 10.00 B: ero offset Range of values: -10,000 to 10,000 On: on threshold Range of values: -20,000 to 20,000 Off: off threshold Range of values: -20,000 to 20,000 p: number of decimals Range of values: 0, 1, 2, 3
	Output Q	Q is set or reset, depending on the difference $A_x - A_y$ and the set thresholds.
* AI1...AI8: 0...10 V corresponds with 0...1000 (internal value).		

#### Gain and offset parameters

For more information on the gain and offset parameters, refer to topic "Calculating the gain and offset of analog values (Page 128)".

## Parameters On and Off

The actual value of another already-programmed function the on threshold On and the off threshold Off. You can use the actual values of the following functions:

- Analog trigger (Page 179) (actual value Ax)
- Analog amplifier (Page 192) (actual value Ax)
- Analog multiplexer (Page 210) (actual value AQ)
- Analog ramp control (Page 213) (actual value AQ)
- Analog Math (Page 225) (actual value AQ)
- PI controller (Page 217) (actual value AQ)
- Up/down counter (Page 169) (actual value Cnt)
- Analog filter (Page 230) (actual value AQ)
- Average value (Page 236) (actual value AQ)
- Max/Min (Page 232) (actual value AQ)
- On-delay (Page 134) (current time Ta)
- Off-delay (Page 137) (current time Ta)
- On-/off-delay (Page 139) (current time Ta)
- Retentive on-delay (Page 141) (current time Ta)
- Interval time-delay relay/Pulse output (Page 143) (current time Ta)
- Edge-triggered interval time-delay relay (Page 145) (current time Ta)
- Asynchronous pulse generator (Page 147) (current time Ta)
- Stairwell light switch (Page 151) (current time Ta)
- Dual-function switch (Page 153) (current time Ta)
- Stopwatch (Page 167) (actual value AQ)
- Analog comparator (actual value Ax - Ay)
- Frequency trigger (Page 176) (actual value Fre)

Select the required function by the block number.

## Parameter p (number of decimals)

Applies only to Ax, Ay, On, Off and  $\Delta$  values displayed in a message text.

Does not apply to the comparison of on and off values! (The compare function ignores the decimal point.)

**Timing diagram**

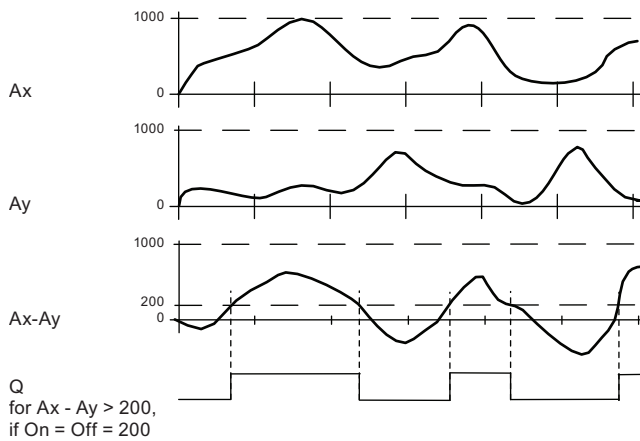

**Functional description**

The function fetches the analog values from the inputs Ax and Ay.

Ax and Ay are each multiplied by the value of the A (gain) parameter, and the value at parameter B (offset) is then added to the relevant product, i.e.

$(Ax \cdot gain) + offset = \text{actual value Ax}$  or  
 $(Ay \cdot gain) + offset = \text{actual value Ay}$ .

The function forms the difference ("Δ") between the actual values Ax - Ay.

Output Q is set or reset, depending on difference of the actual values Ax - Ay and the set thresholds. See the calculation rule below.

**Calculation rule**

- If the On threshold  $\geq$  Off threshold, then Q = 1 if (actual value Ax - actual value Ay) > On or Q = 0 if (actual value Ax - actual value Ay)  $\leq$  Off.
- If the On threshold < Off threshold, then Q = 1, if On  $\leq$  (actual value Ax - actual value Ay) < Off.

**Setting the Par parameter**

The gain and offset parameters are used to adapt the sensors to the relevant application.

View in programming mode:

B3	1/1 +/	← Parameter protection mode
On	=+0	← On threshold
Off	=+0	← Off threshold
A	=+0.00	← Gain
B	=+0	← Offset
P	=0	← Decimals in the message text

## Example

In a heating control system, the supply  $T_v$  and return line temperatures  $T_r$  are to be compared, for example with a sensor at AI2.

A control signal is to be triggered (for example "heater On") when the difference between the supply and return line temperatures is greater than 15 °C. The control signal is reset when the difference is less than 5 °C.

The process variable of the temperature is to be shown in parameter assignment mode.

The thermocouples available have the following technical data: -30 °C to +70 °C, 0 VDC to 10 VDC.

Application	Internal mapping
-30 °C to 70 °C = 0 VDC to 10 VDC	0 to 1000
0 °C	300 → Offset = -30
Range of values: -30 °C to 70 °C = 100	1000 → Gain = 100/1000 = 0.1
On threshold = 15 °C	Threshold = 15
Off threshold = 5 °C	Threshold = 5
See also topic "Calculating the gain and offset of analog values (Page 128)".	

Configuration (example):

B3	1/1 +/	← Parameter protection mode
On	+=15	← On threshold
Off	+=5	← Off threshold
A	+=0.10	← Gain
B	=-30	← Offset
P	=0	← Decimals in the message text (if used)

View in parameter assignment mode (example):

B3	1/1	
On	+=15	← On threshold
Off	+=5	← Off threshold
Ax	+=10	← Temperature values
Ay	=-20	← Temperature values
Δ	+=30	← Q=1 (Δ>On)

View in the message text (example):

Ax	+=10
Ay	=-20

### Reducing the input response of the analog comparator

You can selectively delay the output of an analog comparator by means of the "On-delay" and "Off-delay" special functions. With on-delay, output Q is only set if the pulse width of the triggering signal at input Trg (=analog comparator output) is longer than the on-delay time.

Using this method, you will obtain a virtual hysteresis and reduce the input response to short signals.

### Function block diagram

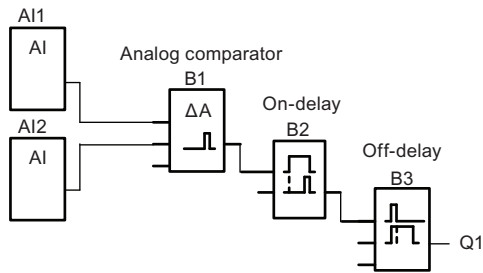

## 4.4.21 Analog watchdog

### Short description

This special function saves the process variable of an analog input to memory, and sets the output when the output variable exceeds or drops below this stored value plus a configurable offset.

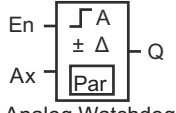
Symbol in IDEC SmartRelay	Wiring	Description
 <p>En — <math>\square</math> A  <math>\pm \Delta</math>          Ax — Par — Q          Analog Watchdog</p>	Input En	A positive edge (0 to 1 transition) at input En saves the analog value at input Ax ("Aen") to memory and starts monitoring of the analog range $A_{en} - \Delta_2$ to $A_{en} + \Delta_1$
	Input Ax	Input Ax is one of the following analog signals: <ul style="list-style-type: none"> <li>• AI1 to AI8 (*)</li> <li>• AM1 to AM64</li> <li>• NAI1 to NAI32</li> <li>• AQ1 to AQ8</li> <li>• NAQ1 to NAQ16</li> <li>• Block number of a function with analog output</li> </ul>
	Parameter	A: gain Range of values: -10.00 to 10.00 B: zero offset Range of values: -10,000 to 10,000 $\Delta_1$ : difference value above Aen: on/off threshold Range of values: 0 to 20,000 $\Delta_2$ : difference value below Aen: on/off threshold Range of values: 0 to 20,000 p: number of decimals Range of values: 0, 1, 2, 3 Retentivity: / = no retentivity R = the status is retentive in memory
	Output Q	Q is set/reset, depending on the stored analog value and the offset.

\* AI1...AI8: 0...10 V corresponds with 0...1000 (internal value).

### Gain and offset parameters

For more information on gain and offset parameters, refer to topic "Calculating the gain and offset of analog values (Page 128)".



## Parameters Delta1 and Delta2

The actual value of another already-programmed function the Delta1 and Delta2 parameters. You can use the actual value of the following functions:

- Analog comparator (Page 184) (actual value Ax – Ay)
- Analog trigger (Page 179) (actual value Ax)
- Analog amplifier (Page 192) (actual value Ax)
- Analog multiplexer (Page 210) (actual value AQ)
- Analog ramp control (Page 213) (actual value AQ)
- Analog Math (Page 225) (actual value AQ)
- PI controller (Page 217) (actual value AQ)
- Up/down counter (Page 169) (actual value Cnt)
- Analog filter (Page 230) (actual value AQ)
- Average value (Page 236) (actual value AQ)
- Max/Min (Page 232) (actual value AQ)
- On-delay (Page 134) (current time Ta)
- Off-delay (Page 137) (current time Ta)
- On-/off-delay (Page 139) (current time Ta)
- Retentive on-delay (Page 141) (current time Ta)
- Interval time-delay relay/Pulse output (Page 143) (current time Ta)
- Edge-triggered interval time-delay relay (Page 145) (current time Ta)
- Asynchronous pulse generator (Page 147) (current time Ta)
- Stairwell light switch (Page 151) (current time Ta)
- Dual-function switch (Page 153) (current time Ta)
- Stopwatch (Page 167) (actual value AQ)
- Frequency trigger (Page 176) (actual value Fre)

Select the required function by the block number.

## Parameter p (number of decimals)

Applies only to the Aen, Ax,  $\Delta_1$  and  $\Delta_2$  values displayed in a message text.

## Timing diagram

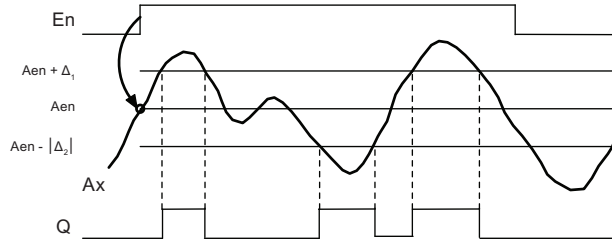

## Functional description

A 0 to 1 transition at input En saves the value of the signal at the analog input Ax. This saved process variable is referred to as "Aen".

Both the analog actual values Ax and Aen are multiplied by the value at parameter A (gain), and parameter B (offset) is then added to the product:

$(Ax \cdot \text{gain}) + \text{offset} = \text{Actual value Aen}$ , when input En changes from 0 to 1, or

$(Ax \cdot \text{gain}) + \text{offset} = \text{Actual value Ax}$ .

Output Q is set when the signal at input En = 1 and if the actual value at input Ax is out of range of  $Aen - \Delta_2$  to  $Aen + \Delta_1$ .

Output Q is reset, when the actual value at input Ax lies within the range of  $Aen - \Delta_2$  to  $Aen + \Delta_1$ , or when the signal at input En changes to lo.

## Setting the Par parameter

The gain and offset parameters are used to adapt the used sensors to the respective application.

View in programming mode:

B3	1/1	+/	← Parameter protection mode
Δ1	=0		← Differential value for the on/off threshold
Δ2	=0		←
A	=+0.00		← Gain
B	=+0		← Offset
P	=0		← Decimals in the message text

View in parameter assignment mode (example):

B3	1/1		
Ax	=+5		← Q = 1 (Ax is out of the range of Aen - Δ2 to Aen + Δ1)
Aen	=-20		
Δ1	=10		
Δ2	=10		

## 4.4.22 Analog amplifier

### Short description

This special function amplifies the value of an analog input and outputs the result at an analog output.

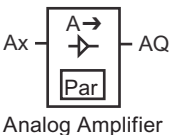
Symbol in IDEC SmartRelay	Wiring	Description
 <p>Symbol for Analog Amplifier: A box containing 'A' with a right-pointing arrow above a right-pointing arrow, and 'Par' in a box below. Input 'Ax' is on the left, output 'AQ' is on the right. Below the box is the text 'Analog Amplifier'.</p>	Input Ax	Input Ax is one of the following analog signals: <ul style="list-style-type: none"> <li>• AI1 to AI8 (*)</li> <li>• AM1 to AM64</li> <li>• NAI1 to NAI32</li> <li>• AQ1 to AQ8</li> <li>• NAQ1 to NAQ16</li> <li>• Block number of a function with analog output</li> </ul>
	Parameter	A: gain Range of values: -10.00 to 10.00 B: zero offset Range of values: -10,000 to 10,000 p: number of decimals Range of values: 0, 1, 2, 3
	Output AQ	This special function has an analog output. This output can only be connected with analog inputs, analog memory markers, analog outputs or network analog outputs. Range of values for AQ: -32767 to 32767
* AI1...AI8: 0 V to 10 V corresponds with 0 to 1000 (internal value).		

### Gain and offset parameters

Please note the information on gain and offset parameters in topic Calculating the gain and offset of analog values (Page 128).

### Parameter p (number of decimals)

Applies only to the AQ value in a message text.

### Functional description

The function fetches the analog signal of input Ax.

This value is multiplied by the value of the A (gain) parameter, and parameter B (offset) is then added to the product:  $(Ax \cdot \text{gain}) + \text{offset} = \text{actual value Ax}$ .

The actual value Ax is output at AQ.

## Analog output

If you interconnect this special function with a real analog output, note that the analog output can only process values between 0 and 1000. To do this, you may need to connect an additional amplifier between the analog output of the special function and the real analog output. Using this amplifier, you standardize the output range of the special function to a value range of 0 to 1000.

## Scaling an analog input value

You can influence the analog input value of a potentiometer by interconnecting an analog input with an analog amplifier and an analog memory marker.

- Scale the analog value at the analog amplifier for further use.
- Connect, for example, the time base for parameter T of a time function (e.g. On-/off-delay (Page 139)) or the on and/or off limit specification of an Up/down counter (Page 169) to the scaled analog value.

For more information with programming examples refer to the Online Help for WindLGC.

## Setting the Par parameter

The gain and offset parameters are used to adapt the sensors to the relevant application.

View in programming mode (example):

B3	1/1	+/	
A	=+2.5		← Gain
B	=-300		← Offset
P	=0		← Decimals in the message text

View in parameter assignment mode (example):

B3	1/1
A	=+2.5
B	=-300
AQ	=-250

### 4.4.23 Latching relay

#### Short description

Input S sets output Q, input R resets output Q again.

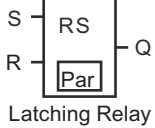
Symbol in IEEC SmartRelay	Wiring	Description
	Input S	You set output Q with a signal at input S.
	Input R	You reset output Q with a signal at input R. If S and R = 1, the output is reset.
	Parameter	Retentivity: / = no retentivity R = the status is retentive.
	Output Q	Q is set with a signal at input S, and reset with a signal at input R.

#### Timing diagram

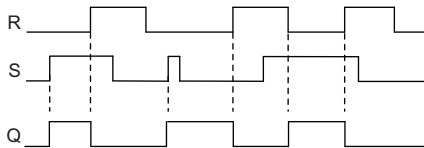

#### Switching response

A latching relay represents a simple binary element. The output value depends on the status at the inputs and on the previous output status. The following table shows the logic once again:

S <sub>n</sub>	R <sub>n</sub>	Q	Comment
0	0	x	The status is retentive
0	1	0	Reset
1	0	1	Set
1	1	0	Reset (takes priority over Set)

When retentivity is enabled, the current status of the output signal is retained after a power failure.

## 4.4.24 Current impulse relay

### Short description

A short pulse at the input sets and resets the output.

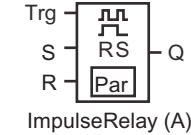
Symbol in IDEC SmartRelay	Wiring	Description
	Input Trg	You set and reset output Q with a signal at input Trg (Trigger).
	Input S	You set output Q with a signal at input S.
	Input R	You reset output Q with a signal at input R.
	Parameter	Selection: RS (R input priority) or SR (S input priority)  Retentivity: / = no retentivity R = the status is retentive.
	Output Q	Q is set with a signal at Trg, and reset with the next signal at Trg, if S and R = 0.

### Timing diagram

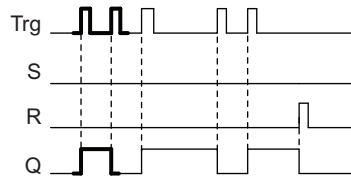

The bold printed section of the timing diagram is also shown in the symbol for the current impulse relay.

### Functional description

Output Q changes its status; that is, the output is set or reset with each 0 to 1 transition at input Trg and if the inputs S and R = 0.

The signal at input Trg does not influence the special function when S or R = 1.

You set the current impulse relay with a signal at input S. The output is set hi.

You reset the current impulse relay with a signal at input R. The output is set lo.

Status diagram

Par	Q <sub>n-1</sub>	S	R	Trg	Q <sub>n</sub>
*	0	0	0	0	0
*	0	0	0	0 ->1	1**
*	0	0	1	0	0
*	0	0	1	0 ->1	0
*	0	1	0	0	1
*	0	1	0	0 ->1	1
RS	0	1	1	0	0
RS	0	1	1	0 ->1	0
SR	0	1	1	0	1
SR	0	1	1	0 ->1	1
*	1	0	0	0	1
*	1	0	0	0 ->1	0**
*	1	0	1	0	0
*	1	0	1	0 ->1	0
*	1	1	0	0	1
*	1	1	0	0 ->1	1
RS	1	1	1	0	0
RS	1	1	1	0 ->1	0
SR	1	1	1	0	1
SR	1	1	1	0 ->1	1

\*: RS or SR

\*\* : Triggering signal is effective, because S and R = 0.

Depending on your configuration, either input R takes priority over input S (input S is not effective when R = 1), or vice versa (input R is not effective when S = 1).

After a power failure, the current impulse relay and output Q are reset if you have not enabled retentivity.

View in programming mode:

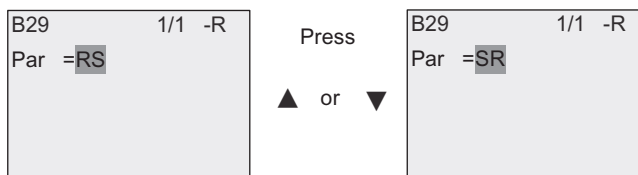

This special function is not available in parameter assignment mode.

**Note**

If Trg = 0 and Par = RS, the special function "Current impulse relay" corresponds with the special function "Latching relay (Page 194)".

## 4.4.25 Message texts

### Short description

With the message text function block, you can configure a message that includes text and other parameters for IDEC SmartRelay to display in RUN mode.

You can configure simple message texts from the IDEC SmartRelay onboard display. WindLGC provides an extended set of features for message texts: bar graph representation of data, names for digital I/O states and more. Refer to the WindLGC documentation for information on these features.

### Global message text settings

You configure global parameters that apply to all message texts on the programming menu:

- Analog time: refresh rate in milliseconds that specifies how frequently analog inputs in message texts are updated
- Tick time: frequency at which message texts scroll on and off the display  
There are two ways that a message text can tick on and off the screen: line by line, or character by character, which are described in more detail below. A line of a text message, or each character of a text message in turn will tick on and off the IDEC SmartRelay onboard display based on the tick time. For a message that ticks line by line, the actual tick time is ten times the configured tick time. For messages that tick character by character, the actual tick time is the configured tick time.
- Current character set: which character set is selected for the display of message texts. Options Set1 and Set2 can be any of the supported character sets for IDEC SmartRelay:

Character set in IDEC SmartRelay	Common name	Supported languages	Internet reference
ISO8859-1	Latin-1	English, German, Italian, Spanish (partly), Dutch (partly)	<a href="http://en.wikipedia.org/wiki/ISO/IEC_8859-1">http://en.wikipedia.org/wiki/ISO/IEC_8859-1</a>
ISO8859-5	Cyrillic	Russian	<a href="http://en.wikipedia.org/wiki/ISO/IEC_8859-5">http://en.wikipedia.org/wiki/ISO/IEC_8859-5</a>
ISO8859-9	Latin-5	Turkish	<a href="http://en.wikipedia.org/wiki/ISO/IEC_8859-9">http://en.wikipedia.org/wiki/ISO/IEC_8859-9</a>
ISO8859-16	Latin-10	French	<a href="http://en.wikipedia.org/wiki/ISO/IEC_8859-16">http://en.wikipedia.org/wiki/ISO/IEC_8859-16</a>
GB-2312	Chinese	Chinese	<a href="http://en.wikipedia.org/wiki/GB2312">http://en.wikipedia.org/wiki/GB2312</a>
Shift-JIS	Japanese	Japanese	<a href="http://en.wikipedia.org/wiki/Shift-jis">http://en.wikipedia.org/wiki/Shift-jis</a>

Of the 50 possible message texts that you can configure, you can select any number of them to be from the first language and any number from the second language. For example, you could configure 50 message text function blocks that have a single message text for Character Set 1. Alternatively, you could configure twenty-five message text function blocks, each of which has two message texts: one for Character Set 1 and one for Character Set 2. Any combination is valid such that the total does not exceed 50.

Within a single message text, the text must be from one character set. You can edit message texts in any of the supported character sets from WindLGC. From IDEC SmartRelay Basic, you can only edit text using characters from the ISO8859-1 character set.

The language and therefore character set of a message text is independent of the language setting for menus on the IDEC SmartRelay onboard display. They can be different.



### Chinese character set

IDEC SmartRelay Basic and the FL1F-RD1 support the Chinese character set (GB-2312) for the People's Republic of China. The devices use Microsoft Windows encoding for this character set. The Windows encoding allows the devices to display the same characters as shown in the WindLGC message text editor when you are using a Chinese emulator or a Chinese version of Microsoft Windows.

The Chinese character set requires a Chinese version of Windows or a Chinese emulator to properly display Chinese characters in the WindLGC message text editor. You must start the Chinese emulator before you open the message text function block in WindLGC.

### Programming global message text parameters

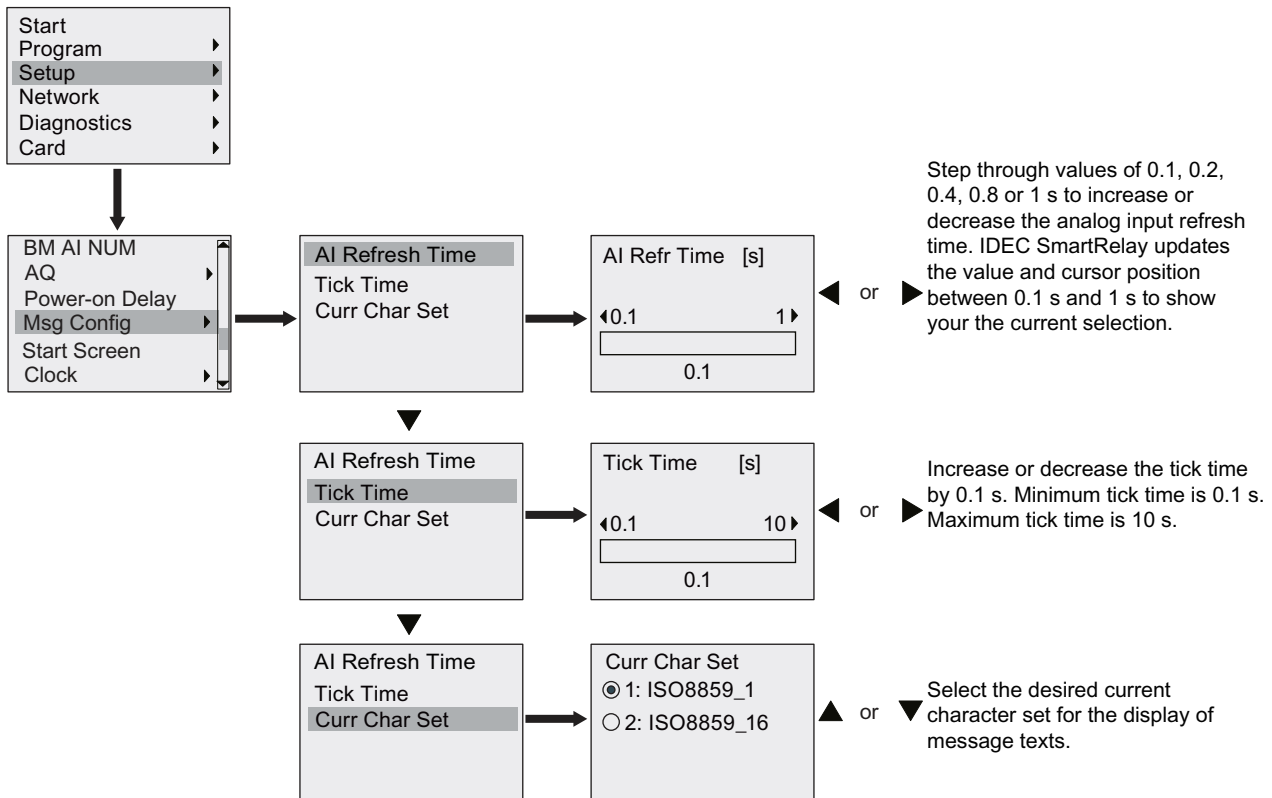

## Message text function block

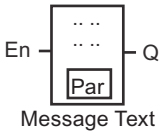
Symbol in IDEC SmartRelay	Wiring	Description
	Input En	A 0 to 1 transition at input En (Enable) starts the output of the message text.
	Parameter	Ack: acknowledgment of the message text Msg Text: input of the message text Priority: priority of the message text Range of values: 0 to 127 Tick Type: <ul style="list-style-type: none"> <li>• C-C: tick message character by character</li> <li>• L-L: tick message line by line</li> </ul> Msg. Dst: message destination (BM, TDE or Both) Web Show: show IDEC SmartRelay Basic on Web server Line tick settings (to define whether a line ticks): <ul style="list-style-type: none"> <li>• Line1 Tick</li> <li>• Line2 Tick</li> <li>• Line3 Tick</li> <li>• Line4 Tick</li> <li>• Line5 Tick</li> <li>• Line6 Tick</li> </ul> <p><b>Note:</b> You can only edit the Text parameter of the message from IDEC SmartRelay Basic. ISO8859-1 is the only available character set for editing text. You can edit all other parameters, and other languages for the Text parameter from WindLGC. For configuration details, refer to the Online Help for WindLGC.</p>
	Output Q	Q remains set as long as the message text is set.

### Restriction

A maximum of 50 message text blocks are available.

### Functional description

When IDEC SmartRelay is in RUN mode, IDEC SmartRelay displays the message text that you have configured along with its parameter values upon a 0 to 1 transition of the signal at input En.

Based on your setting for the message destination, the message text displays on the IDEC SmartRelay onboard display, the FL1F-RD1, or both.

If you use marker M27 in your circuit program, then if M27=0 (low) then IDEC SmartRelay displays the message text only if it is from the primary character set (Character Set 1). If M27=1 (high), then IDEC SmartRelay displays the message text only if it is from the secondary character set (Character Set 2). (See the M27 marker description in topic Constants and connectors (Page 113)).

If you have configured message ticking, the message will tick on and off the display according to your specifications, either a character at a time, or a line at a time.

If acknowledgment is disabled (Ack = No), the message text is hidden when the status of the signal at input En changes from 1 to 0.

If acknowledgment is enabled (Ack = Yes) and the status of the signal at input En changes from 1 to 0, the message text is output until it is acknowledged with **OK**. When En = 1, you cannot acknowledge the message text.

When multiple message text functions are triggered with En=1, IDEC SmartRelay displays the message text with the highest priority (0 = lowest, 127 = highest). This also means that IDEC SmartRelay displays a newly activated message text only if its priority is higher than that of previously activated message texts.

After a message text is disabled or acknowledged, the function automatically shows the previously active message text that takes the highest priority.

You can press the ▲ and ▼ keys to step through multiple active message texts.

## Example

This is how two message texts could be shown:

Display field of IDEC SmartRelay in RUN mode

```
Motor 5
STOP AT
10:12
!!Action!!
START AT
11:30
```

Example: Message text with priority 30

Press  
▼ ▲

```
Motor 2
3000
hours
MAINTENANCE
START AT
13:30
```

Example: Message text with priority 10

Press  
▼ ▲

```
Mo 09:00
2003-01-27
```

Date and current time-of-day  
(only for versions with real-time clock)

## Message ticking

You can configure message text lines to tick or not tick. Two types of message ticking exist:

- Character by character
- Line by line

Messages that tick character by character scroll off the characters of the message line one character at a time to the left with the additional characters scrolling in one at a time from the right. The time interval for the tick is specified by the TickTime message text setting.

Messages that tick line by line scroll one half of the message off the display to the left with the second half of the message scrolling in from the right. The time interval for the tick is ten times the TickTime parameter. The two halves of the message simply alternate on the IDEC SmartRelay onboard display or FL1F-RD1.

### Example: tick message character by character

The following illustration shows a one-line, 24-character message text:

X1	X2	X3	X4	X5	X6	X7	X8	X9	X10	X11	X12	X13	X14	X15	X16	X17	X18	X19	X20	X21	X22	X23	X24

If you set this message to tick "character by character" with a tick interval of 0.1 seconds, then the initial appearance of this message line on the IDEC SmartRelay onboard display or FL1F-RD1 is as shown in this illustration:

X1	X2	X3	X4	X5	X6	X7	X8	X9	X10	X11	X12	X13	X14	X15	X16	X17	X18	X19	X20	X21	X22	X23	X24
----	----	----	----	----	----	----	----	----	-----	-----	-----	-----	-----	-----	-----	-----	-----	-----	-----	-----	-----	-----	-----

After 0.1 second, one character of the message line ticks. The message appears as follows on the IDEC SmartRelay onboard display or FL1F-RD1:

X2	X3	X4	X5	X6	X7	X8	X9	X10	X11	X12	X13	X14	X15	X16	X17	X18	X19	X20	X21	X22	X23	X24	X1
----	----	----	----	----	----	----	----	-----	-----	-----	-----	-----	-----	-----	-----	-----	-----	-----	-----	-----	-----	-----	----

### Example: tick message line by line

The following example uses the same message configuration as the previous example:

X1	X2	X3	X4	X5	X6	X7	X8	X9	X10	X11	X12	X13	X14	X15	X16	X17	X18	X19	X20	X21	X22	X23	X24

If you set this message to tick "line by line" with a tick interval of 0.1 seconds, then the initial appearance of this message on the IDEC SmartRelay onboard display or FL1F-RD1 is the left half of the message as shown in this illustration:

X1	X2	X3	X4	X5	X6	X7	X8	X9	X10	X11	X12	X13	X14	X15	X16	X17	X18	X19	X20	X21	X22	X23	X24
----	----	----	----	----	----	----	----	----	-----	-----	-----	-----	-----	-----	-----	-----	-----	-----	-----	-----	-----	-----	-----

After 1 second (10 x 0.1 second), the message ticks to show the right half of the message as shown in this illustration:

X13 X14 X15 X16 X17 X18 X19 X20 X21 X22 X23 X24 X1 X2 X3 X4 X5 X6 X7 X8 X9 X10 X11 X12

The screen display alternates between the two message halves every second.

You can configure each individual line of a message text to tick or not tick. The "character by character" or "line by line" setting applies to all lines that you configure to tick.

### Setting the Par parameter

From the input P, you configure the following characteristics of the message text:

- Priority
- Acknowledgement
- Message destination
- Tick type, and tick setting for each line

View in programming mode:

B33	1/3	+/-	← "+" means: The parameters and actual values in an active message text can be edited
Ack	=No		← Status of the acknowledgement
Msg Text	=...		
Priority	=000		← Priority
Tick Type	=C-C		
Msg. Dst	=TDE		

1. Press **▶** to position the cursor on the "ACK" line.
2. Press **OK**. Enable "Ack": Press **▲** or **▼**.
3. Position the cursor on the "Msg Text" line by pressing **▶**. Press **OK** twice. To select a line for the message text, press **▲** and **▼**. IDEC SmartRelay shows as follows:

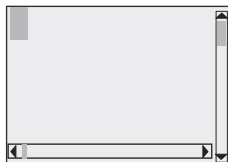

4. Press **▲** and **▼** to select the letter to be displayed in the text. To move the cursor from one position to another, press **◀** and **▶**.

---

#### Note

The list of available characters is the same as for the circuit program name. The character set is found in topic Circuit program input (Page 65). When you enter message text from IDEC SmartRelay Basic, you can only enter characters from the ISO8859-1 character set. To enter text from another language, you must enter the text in WindLGC.

Note that the number of characters per line of message text can be greater than the number of character positions on the IDEC SmartRelay onboard display.

---

5. Confirm your entries with **OK**.
6. Press **▶** to position the cursor on the "Priority" line.
7. Increase the priority by pressing **▲**.
8. Press **▶** to position the cursor on the "Msg. Dst" line.

B33	1/3	+/
Ack	=No	
Msg Text	=...	
Priority	=001	
Tick Type	=C-C	
Msg. Dst	=TDE	

← Message destination: IDEC SmartRelay Basic Module, FL1F-RD1, or both

9. Press **▲** or **▼** to toggle through the three choices for message destination: BM, TDE, or Both.
10. Press **◀** to position the cursor on the "Tick Type" line.

B33	1/3	+/
Ack	=No	
Msg Text	=...	
Priority	=001	
Tick Type	=C-C	
Msg. Dst	=TDE	

← Tick Type: character by character (C-C) or line by line (L-L)

11. Press **▲** or **▼** to select either "C-C" or "L-L" for the "Tick Type".
12. Enable or disable ticking for each line of the message text by pressing **▶**. IDEC SmartRelay displays as follows:

B33	2/3	+/
Web Show	=No	
Line1 Tick	=No	
Line2 Tick	=No	
Line3 Tick	=No	
Line4 Tick	=No	

No: Disable message text display on the Web server  
Yes: Enable message text display on the Web server

No: Line does not tick  
Yes: Line ticks

13. To choose between "No" and "Yes" to define whether Line 1 ticks, press **▲** or **▼**.
14. Press **▶** to move the cursor to the second line, and press **▲** or **▼** to choose between "No" and "Yes" for Line 2. Configure line ticking for lines 3, 4, 5 and 6 in the same way as for lines 1 and 2.
15. Position the cursor on the "Web Show" line by pressing **▶**. Press **▲** or **▼** to select between "No" and "Yes" for "Web Show".
16. Press **OK** to confirm the complete message text configuration.

**Visible parameters or process variables**

The following parameters or process variables can be displayed in a message text, as either numerical values or bar-graph representations of values:

Special function	Parameter or process variable visible in a message text
<b>Timers</b>	
On-delay	T, T <sub>a</sub>
Off-delay	T, T <sub>a</sub>
On-/Off-delay	T <sub>a</sub> , TH, TL
Retentive on-delay	T, T <sub>a</sub>
Interval time-delay relay (pulse output)	T, T <sub>a</sub>
Edge-triggered interval time-delay relay	T <sub>a</sub> , TH, TL
Asynchronous pulse generator	T <sub>a</sub> , TH, TL
Random generator	T <sub>H</sub> , TL
Stairwell light switch	T <sub>a</sub> , T, T!, T!L
Dual-function switch	T <sub>a</sub> , T, TL, T!, T!L
Seven-day time switch	3*on/off/day
Twelve-month time switch	On, Off
Astronomical clock	Longitude, latitude, zone, TS, TR
Stopwatch	TB, Ta, Lap, AQ
<b>Counter</b>	
Up/down counter	Cnt, On, Off
Operating hours counter	MI, Q, OT
Frequency trigger	f <sub>a</sub> , On, Off, G_T
<b>Analog</b>	
Analog trigger	On, Off, A, B, Ax
Analog differential trigger	On, n, A, B, Ax, Off
Analog comparator	On, Off, A, B, Ax, Ay, nA
Analog watchdog	n, A, B, Ax, Aen
Analog amplifier	A, B, Ax
Analog multiplexer	V1, V2, V3, V4, AQ
Analog ramp control	L1, L2, MaxL, StSp, Rate, A, B, AQ
PI controller	SP, Mq, KC, TI, Min, Max, A, B, PV, AQ
Analog math	V1, V2, V3, V4, AQ
PWM (Pulse Width Modulator)	A, B, T, Ax amplified
<b>Miscellaneous</b>	
Latching relay	-
Current impulse relay	-
Message texts	-
Softkey	On/Off
Shift register	-
Analog filter	Sn, Ax, AQ

Special function	Parameter or process variable visible in a message text
Max/Min	Mode, Min, Max, Ax, AQ
Average value	Ax, St, Sn, AQ
Float /Integer Converter	Typ, VM, Res, eAx, Aq,
Integer/Float Converter	Typ, VM, Res, eAx, eAq, Aq,

For timers, a message text can also display the remaining time. "Remaining time" refers to how much time of the parameter setting remains.

Bar graphs can be either horizontal or vertical representations of the current or actual value scaled between the minimum and maximum value. For more information on configuring and displaying bar graphs in message texts, refer to the Online Help for WindLGC.

### Editing message texts

You can only edit simple message texts from IDEC SmartRelay Basic. You cannot edit message texts that contain features such as bar graphs, I/O status names, and others from IDEC SmartRelay Basic. You can only edit these types of message texts from WindLGC.

Also, you **cannot** edit message texts from IDEC SmartRelay Basic that contain any of the following parameters:

- Par
- Time
- Date
- EnTime
- EnDate
- Analog input
- Digital I/O status
- Special characters (for example: ±, €)

You can only edit such message texts from WindLGC.

### Changing parameters in the active message text

When the message text is active, press **ESC** to select the editing mode.

---

#### Note

You must keep the **ESC** key pressed for at least one second.

---

Press ◀ and ▶ to select the relevant parameter. Press **OK** to change the parameter. Use the ▲ and ▼ keys to edit a parameter.

Confirm your changes with **OK**. You can now edit further parameters in the message text (if any exist). Press **ESC** to exit editing mode.

### Key input simulation in the active message text

You can enable the four cursor keys C ▲, C ▼, C ◀ and C ▶ in an active message text by pressing **ESC** plus the relevant cursor key.



### 4.4.26 Softkey

#### Short description

This special function has the effect of a mechanical pushbutton or switch.

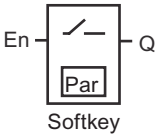
Symbol in IDEC SmartRelay	Wiring	Description
	Input En	Output Q is set with a 0 to 1 transition of the signal at input En (Enable), and if "Switch=On" was confirmed in parameter assignment mode.
	Parameter	Programming mode: Selecting the function for pushbutton action for the duration of one cycle, or for switching action. Start: on or off state, initialized at the first start of the program. Retentivity: / = no retentivity R = the status is retentive. Parameter assignment mode (RUN mode): Switch: switches the momentary pushbutton (switch) on or off.
	Output Q	Switches on if En=1 and Switch=On was confirmed with OK.

#### Factory setting

The default parameter setting is switching action.

#### Timing diagram

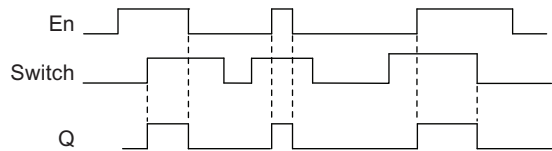

## Functional description

In parameter assignment mode, the output is set with a signal at input En, if the "Switch" parameter is set to "On" and confirmed with **OK**. Whether the function was configured for pushbutton or switching action is of no concern here.

The output is reset to "0" in the following three cases:

- After a 1 to 0 transition at input En
- When the function was configured for momentary pushbutton action, and one cycle has expired since it was switched on
- When the position "Off" was selected at the "Switch" parameter and confirmed with **OK** in parameter assignment mode

If retentivity is not set, output Q is initialized after a power failure according to your configuration at the "Start" parameter.

## Setting the Par parameter

View in programming mode (example):

1. Position the cursor on "Par". Press **OK**.
2. Press **▶** to position the cursor on the "On" line.

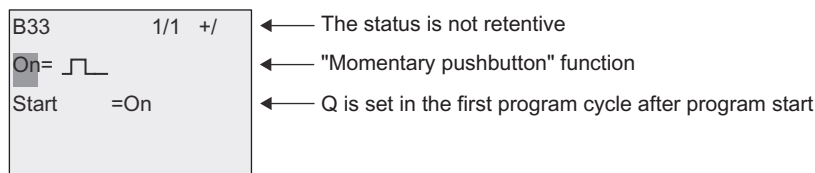

3. Press **OK**. Select "Momentary pushbutton" or "Switch": Press **▲** or **▼**.

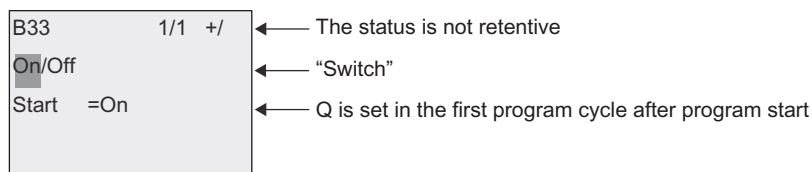

4. Press **▶** to move the cursor to "Start" line.
5. To change the "Start" state: Press **▲** or **▼**.

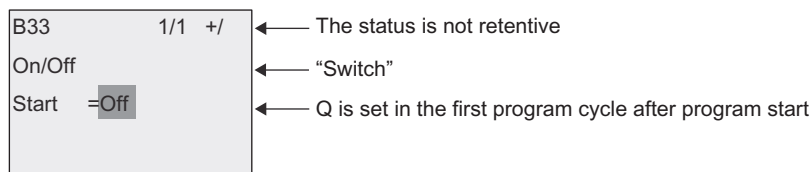

6. Confirm your entries with **OK**.

View in parameter assignment mode (example):

Here, you can set or reset the "Switch" parameter (On/Off). When in RUN, IDEC SmartRelay shows the following display:



Let us assume you want to set "Switch" (On).

1. Press **OK** (the cursor is now positioned on "Off").
2. To change from "Off" to "On": Press **▲** or **▼**.
3. Confirm your entries with **OK**.

### 4.4.27 Shift register

#### Short description

You can use the shift register function to read the value of an input and to shift its bits left or right. The output value corresponds with the configured shift register bit. The shifting direction can be changed at a special input.

Symbol in IDEC SmartRelay	Wiring	Description
<p>Shift Register</p>	Input In	Input read at the start of the function.
	Input Trg	A positive edge (0 to 1 transition) at input Trg (Trigger) starts the special function. 1 to 0 transitions are irrelevant.
	Input Dir	The signal at input Dir determines the shifting direction for the shift register bits Sx.1 to Sx.8. "x" refers to the configured shift register byte index 1, 2, 3, or 4. Dir = 0: shift up (Sx.1>>Sx.8) Dir = 1: shift down (Sx.8>>Sx.1)
	Input R	The SFB is reset with a positive edge (0 to 1 transition) at input R (Reset). All the shift register bit (Sx.1 to Sx.8) are set to 0 when the SFB is reset.
	Parameter	Shift register bit that determines the value at output Q. Possible settings: Byte index: 1 to 4 Q: S1 to S8 IDEC SmartRelay provides a maximum of 32 shift register bits, with eight bits per shift register. Retentivity: / = no retentivity R = the status is retentive.
Output Q	The output value corresponds with the configured shift register bit.	

**Functional description**

The function reads the value at input In with a positive edge (0 to 1 transition) at input Trg (Trigger).

This value is applied to shift register bit Sx.1 or Sx.8 depending on the shifting direction, where "x" refers to the index number of the shift register and the number after the decimal point refers to the bit number:

- Shift up: the value at input In is set at Sx.1; the previous value at Sx.1 is shifted to Sx.2; the previous value at Sx.2 is shifted to Sx.3 etc.
- Shift down: the value at input In is set at Sx.8; the previous value at Sx.8 is shifted to Sx.7; the previous value at Sx.7 is shifted to Sx.6 etc.

Output Q returns the value of the configured shift register bit.

If retentivity is disabled, the shift function restarts at Sx.1 or Sx.8 after a power failure. When enabled, retentivity always applies to all shift register bits.

**Note**

There are a maximum of four shift register function blocks available for use in the circuit program in IDEC SmartRelay.

**Timing diagram**

The timing diagram example for the shift register in IDEC SmartRelay is shown as follows:

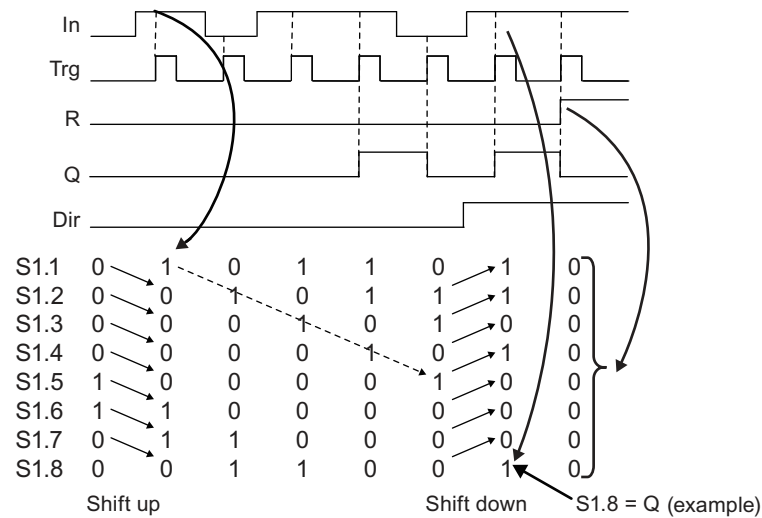

**Setting the Par parameter**

View in programming mode (example):

B10	1/1	-R	← Retentivity enabled
Byte index =	4		← You can select a byte index from 1 to 4
Q	= 08		← You can select a bit number from 1 to 8

The view above indicates that the configured shift register bit is S4.8.

This special function is not available in parameter assignment mode.

### 4.4.28 Analog multiplexer

#### Short description

This special function outputs one of four predefined analog values or 0 at the analog output.

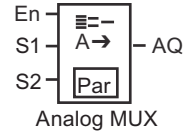
Symbol in IDEC SmartRelay	Wiring	Description
 <p>En S1 S2 Analog MUX</p>	Input En	A change in status from 0 to 1 at input En (Enable) switches a parameterized analog value to the output AQ, depending on the value of S1 and S2.
	Inputs S1 and S2	S1 and S2 (selectors) for selecting the analog value to be issued. <ul style="list-style-type: none"> <li>• S1 = 0 and S2 = 0: value 1 is issued.</li> <li>• S1 = 0 and S2 = 1: value 2 is issued.</li> <li>• S1 = 1 and S2 = 0: value 3 is issued.</li> <li>• S1 = 1 and S2 = 1: value 4 is issued.</li> </ul>
	Parameter	V1 to V4: analog values that will be issued. Range of values: -32768 to 32767 p: number of decimals Range of values: 0, 1, 2, 3
	Output AQ	This special function has an analog output. This output can only be connected with analog inputs, analog memory markers, analog outputs or network analog outputs. Range of values for AQ: -32768 to 32767

## Parameters V1...V4

The analog values for the parameters V1 to V4 can be derived from another already-programmed function. You can use the actual values of the following functions:

- Analog comparator (Page 184) (actual value Ax – Ay)
- Analog trigger (Page 179) (actual value Ax)
- Analog amplifier (Page 192) (actual value Ax)
- Analog ramp control (Page 213) (actual value AQ)
- Analog Math (Page 225) (actual value AQ)
- PI controller (Page 217) (actual value AQ)
- Up/down counter (Page 169) (actual value Cnt)
- Analog multiplexer (actual value AQ)
- Analog filter (Page 230) (actual value AQ)
- Average value (Page 236) (actual value AQ)
- Max/Min (Page 232) (actual value AQ)
- On-delay (Page 134) (current time Ta)
- Off-delay (Page 137) (current time Ta)
- On-/off-delay (Page 139) (current time Ta)
- Retentive on-delay (Page 141) (current time Ta)
- Interval time-delay relay/Pulse output (Page 143) (current time Ta)
- Edge-triggered interval time-delay relay (Page 145) (current time Ta)
- Asynchronous pulse generator (Page 147) (current time Ta)
- Stairwell light switch (Page 151) (current time Ta)
- Dual-function switch (Page 153) (current time Ta)
- Stopwatch (Page 167) (actual value AQ)
- Frequency trigger (Page 176) (actual value Fre)

Select the required function by the block number. For information on parameter defaults, refer to the On-delay (Page 134) topic.

## Parameter p (number of decimals)

Applies only to the values displayed in a message text.

**Timing diagram**

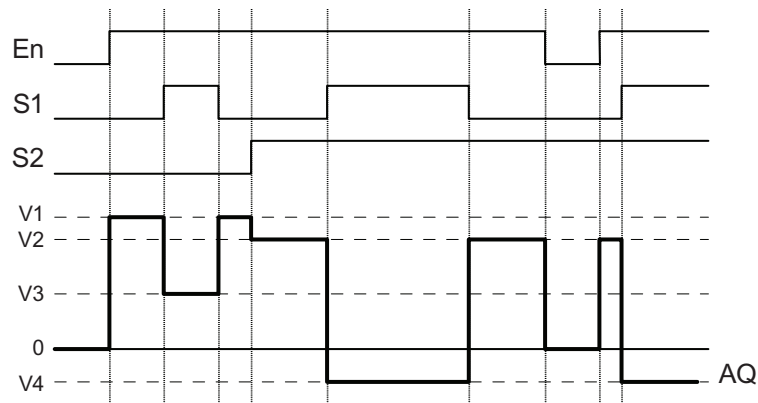

**Functional description**

If input En is set, then the function issues one of four possible analog values V1 to V4 at the output AQ, depending on the value of S1 and S2.

If the input En is not set, then the function issues the analog value 0 at output AQ.

**Analog output**

If you interconnect this special function with a real analog output, note that the analog output can only process values between 0 and 1000. To do this, you may need to connect an additional amplifier between the analog output of the special function and the real analog output. Using this amplifier, you standardize the output range of the special function to a value range of 0 to 1000.

**Setting the Par parameter**

View in programming mode (example):

B3	1/1	+/
V1	=+4000	
V2	=-2000	
V3	=+0	
V4	=+0	
p	=0	

View in parameter assignment mode:

B3	1/1
V1	=+4000
V2	=-2000
V3	=+0
V4	=+0
AQ	=+0

## 4.4.29 Analog ramp control

### Short description

This function allows the output to be changed from the current level to the selected level at a specified rate.

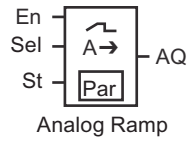
Symbol in IDEC SmartRelay	Wiring	Description
 <p>Analog Ramp</p>	Input En	<p>A change in the status from 0 to 1 at input En (Enable) applies the start/stop level (Offset "B" + StSp) to the output for 100 ms and starts the ramp operation to the selected level.</p> <p>A change in the status from 1 to 0 immediately sets the current level to Offset "B", which makes output AQ equal to 0.</p>
	Input Sel	<p>Sel = 0: level 1 is selected.</p> <p>Sel = 1: level 2 is selected.</p> <p>A change in status of Sel causes the current level to start changing to the selected level at the specified rate.</p>
	Input St	<p>A change in the status from 0 to 1 at input St (Decelerated Stop) causes the current level to decrease at a constant rate until the start/stop level (Offset "B" + StSp) is reached. The start/stop level is maintained for 100 ms and then the current level is set to Offset "B", which makes output AQ equal to 0.</p>



Symbol in IDEC SmartRelay	Wiring	Description
	Parameter	Level 1 and Level 2: levels to be reached Range of values for each level: -10000 to 20000 MaxL: maximum value that must not be exceeded under any circumstances. Range of values: -10000 to 20000 StSp: Start/Stop offset: value that is added to Offset "B" to create the start/stop level. If the Start/Stop offset is 0, then the start/stop level is Offset "B". Range of values: 0 to 20000 Rate: acceleration with which level 1, level 2 or Offset is reached. Steps/seconds are issued. Range of values: 1 to 10000 A: gain Range of values: 0 to 10.00 B: offset Range of values: -10000 to 10000 p: number of decimals Range of values: 0, 1, 2, 3
	Output AQ	Range of values for AQ: 0 to 32767 $(\text{Current Level} - \text{Offset "B"}) / \text{Gain "A"}$ Range of values: 0 to 32767 <b>Note:</b> When AQ is displayed in parameter mode or message mode, it is displayed as a scaled value, both on the IDEC SmartRelay Base Module and WindLGC (engineering units: current level).

## Parameters L1, L2

The analog values for the parameters L1 and L2 can be derived from another already-programmed function. You can use the actual values of the following functions:

- Analog comparator (Page 184) (actual value  $A_x - A_y$ )
- Analog trigger (Page 179) (actual value  $A_x$ )
- Analog amplifier (Page 192) (actual value  $A_x$ )
- Analog multiplexer (Page 210) (actual value AQ)
- Analog Math (Page 225) (actual value AQ)
- PI controller (Page 217) (actual value AQ)
- Up/down counter (Page 169) (actual value Cnt)
- Analog filter (Page 230) (actual value AQ)
- Average value (Page 236) (actual value AQ)
- Max/Min (Page 232) (actual value AQ)
- On-delay (Page 134) (current time  $T_a$ )
- Off-delay (Page 137) (current time  $T_a$ )
- On-/off-delay (Page 139) (current time  $T_a$ )
- Retentive on-delay (Page 141) (current time  $T_a$ )
- Interval time-delay relay/Pulse output (Page 143) (current time  $T_a$ )
- Edge-triggered interval time-delay relay (Page 145) (current time  $T_a$ )
- Asynchronous pulse generator (Page 147) (current time  $T_a$ )
- Stairwell light switch (Page 151) (current time  $T_a$ )
- Dual-function switch (Page 153) (current time  $T_a$ )
- Stopwatch (Page 167) (actual value AQ)
- Analog ramp control (actual value AQ)
- Frequency trigger (Page 176) (actual value  $F_{re}$ )

Select the required function by the block number. For information on parameter defaults, refer to the On-delay (Page 134) topic.

## Parameter p (number of decimals)

Applies only to the AQ, L1, L2, MaxL, StSp and Rate values displayed in a message text.

**Timing diagram for AQ**

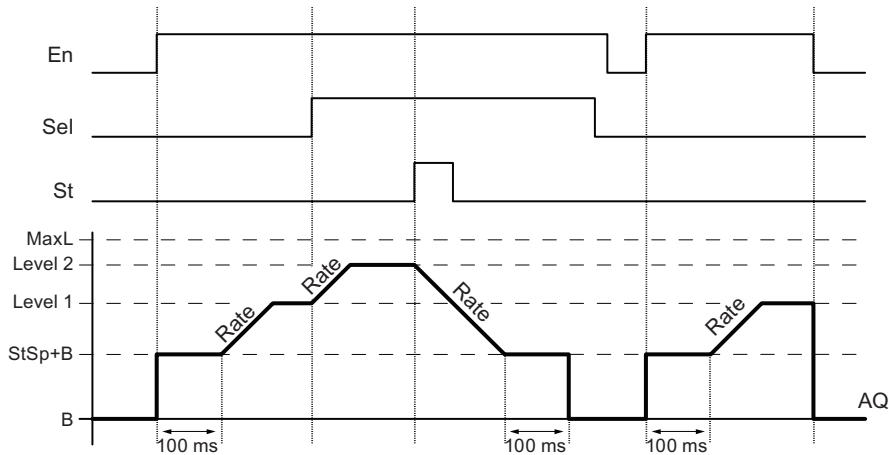

**Functional description**

If the input En is set, then the function sets the current level to StSp + Offset "B" for 100 ms.

Then, depending on the connection of Sel, the function runs from the level StSp + Offset "B" to either level 1 or level 2 at the acceleration set in Rate.

If the input St is set, the function runs to a level of StSp + Offset "B" at the acceleration set in Rate. Then the function holds the level at StSp + Offset "B" for 100 ms. After 100 ms, the level is set to Offset "B". The scaled value (output AQ) is 0.

If the input St is set, the function can only be restarted after the inputs St and En have been reset.

If input Sel has been changed, depending on the connection of Sel, the function runs from the current target level to the new target level at the rate that is specified.

If the input En is reset, the function immediately sets the current level to Offset "B".

The current level is updated every 100 ms. Note the following relationship between output AQ and the current level:

$$\text{Output AQ} = (\text{current level} - \text{Offset "B"}) / \text{Gain "A"}$$

**Note**

For further information on analog value processing, please refer to the Online Help for WindLGC.

## Setting the Par parameter

View in programming mode (example):

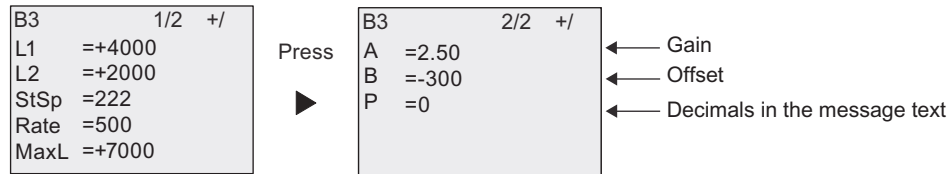

View in parameter assignment mode:

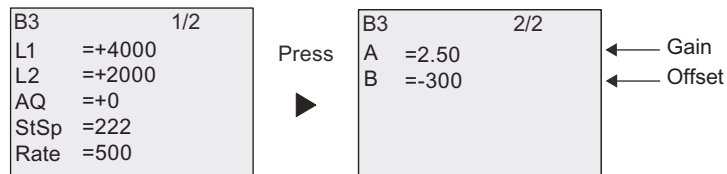

### 4.4.30 PI controller

#### Short description

Proportional-action and integral-action controllers. You can use both types of controller individually or combined.

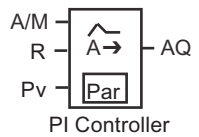
Symbol in IDEC SmartRelay	Wiring	Description
 <p>PI Controller</p>	Input A/M	Set the mode of the controller: 1: automatic mode 0: manual mode
	Input R	Use the input R to reset the output AQ. As long as this input is set, the input A/M is disabled. Output AQ is set to 0.
	Input PV	Analog value: process variable, influences the output
	Parameter	SP: set-value assignment Range of values: -10,000 to 20,000 KC: gain Range of values: 00.00 to 99.99 TI: integral time Range of values: 00:01m to 99:59 m Dir: action direction of the controller Range of values: + or - Mq: value from AQ with manual mode Range of values: 0 to 1,000 Min: minimum value for PV Range of values: -10,000 to 20,000 Max: maximum value for PV Range of values: -10,000 to 20,000 A: gain Range of values: -10.00 to 10.00 B: offset Range of values: -10,000 to 10,000 p: number of decimals Range of values: 0, 1, 2, 3
	Output AQ	This special function has an analog output (= manipulated variable). This output can only be connected with analog inputs, analog memory markers, analog outputs or network analog outputs. Range of values for AQ: 0 to 1,000

## Parameters SP and Mq

The set-value SP and the value for Mq can be provided by another already-programmed function. You can use the actual values of the following functions:

- Analog comparator (Page 184) (actual value Ax – Ay)
- Analog trigger (Page 179) (actual value Ax)
- Analog amplifier (Page 192) (actual value Ax)
- Analog multiplexer (Page 210) (actual value AQ)
- Analog ramp control (Page 213) (actual value AQ)
- Analog Math (Page 225) (actual value AQ)
- Up/down counter (Page 169) (actual value Cnt)
- Analog filter (Page 230) (actual value AQ)
- Average value (Page 236) (actual value AQ)
- Max/Min (Page 232) (actual value AQ)
- On-delay (Page 134) (current time Ta)
- Off-delay (Page 137) (current time Ta)
- On-/off-delay (Page 139) (current time Ta)
- Retentive on-delay (Page 141) (current time Ta)
- Interval time-delay relay/Pulse output (Page 143) (current time Ta)
- Edge-triggered interval time-delay relay (Page 145) (current time Ta)
- Asynchronous pulse generator (Page 147) (current time Ta)
- Stairwell light switch (Page 151) (current time Ta)
- Dual-function switch (Page 153) (current time Ta)
- Stopwatch (Page 167) (actual value AQ)
- PI controller (actual value AQ)
- Frequency trigger (Page 176) (actual value Fre)

Select the required function by the block number. For information on parameter defaults, refer to the On-delay (Page 134) topic.

## Parameters KC, TI

Please note the following circumstances:

- If parameter KC has value 0, the "P" function (proportional control) will not be executed.
- If parameter TI has value 99:59 m, the "I" function (integral-action control) will not be executed.

## Parameter p (number of decimals)

Applies only to the PV, SP, Min and Max values displayed in a message text.

### Timing diagram

The nature, manner and speed with which the AQ changes depend on the parameters KC and TI. Thus, the course of AQ in the diagram is merely an example. A control action is continuous; therefore the diagram portrays just an extract.

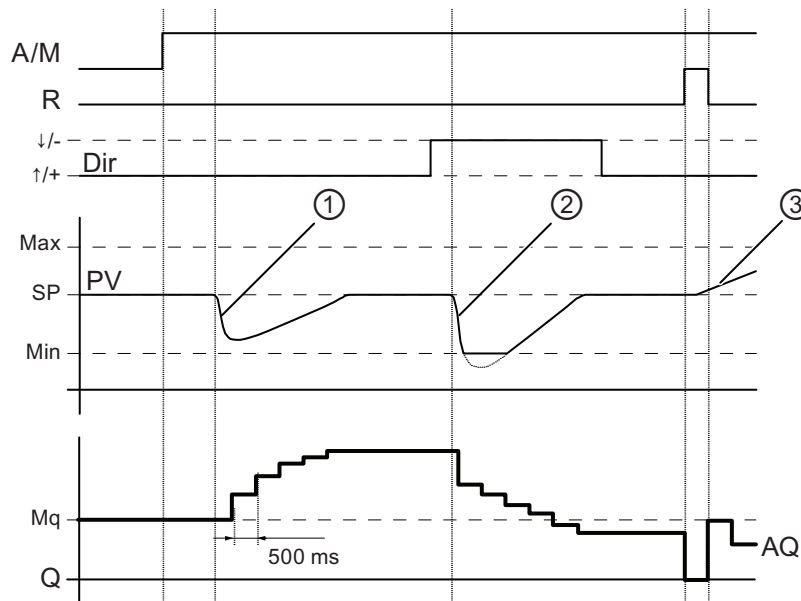

1. A disturbance causes the PV to drop, as Dir is positioned upwards, AQ increases until PV corresponds again to SP.
2. A disturbance causes the PV to drop, as Dir is positioned downwards, AQ decreases until PV corresponds again to SP.  
 It is not possible to change the direction (Dir) at runtime of the function. The change is shown here for illustrative purposes only.
3. As AQ is set to 0 by means of the input R, PV changes. This is based on the fact that PV increases, which on account of Dir = upwards causes AQ to drop.

### Functional description

If the input A/M is set to 0, then the special function issues output AQ with the value that you set with parameter Mq.

If the input A/M is set to 1, then automatic mode commences. As an integral sum the value Mq is adopted, the controller function begins the calculations.

#### Note

For further information on the controller basics, please refer to the Online Help for WindLGC.

The updated value PV is used to calculate in the formulas:

$$\text{Updated value PV} = (\text{PV} \cdot \text{gain}) + \text{offset}$$

- If the updated value PV = SP, then the special function does not change the value of AQ.
- Dir = upwards (+) (timing diagram numbers 1. and 3.)
  - If the updated value PV > SP, then the special function reduces the value of AQ.
  - If the updated value PV < SP, then the special function increases the value of AQ.

- Dir = downwards (-) (timing diagram number 2.)
  - If the updated value PV > SP, then the special function increases the value of AQ.
  - If the updated value PV < SP, then the special function reduces the value of AQ.

With a disturbance, AQ continues to increase / decrease until the updated value PV again corresponds to SP. The speed with which AQ changes depends on the parameters KC and TI.

If the input PV exceeds the parameter Max, then the updated value PV is set to the value of Max. If the PV falls short of the parameter Min, then the updated value PV is set to the value of Min.

If the input R is set to 1, then the AQ output is reset. As long as R is set, the input A/M is disabled.

### Sampling time

The sampling time is fixed at 500 ms.

### Parameter sets

For more information and application examples with application-related parameter sets for KC, TI and Dir, refer to the Online Help for WindLGC.

### Setting the Par parameter

View in programming mode (example):



View in parameter assignment mode:

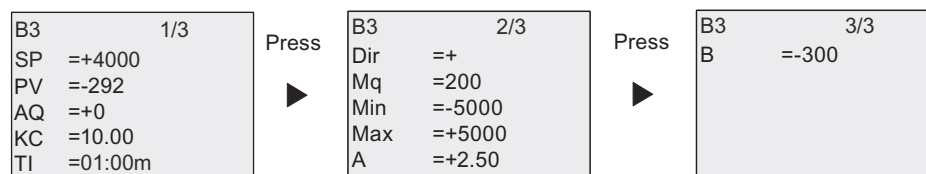



### 4.4.31 Pulse width modulator (PWM)

#### Short description

The Pulse Width Modulator (PWM) instruction modulates the analog input value Ax to a pulsed digital output signal. The pulse width is proportional to the analog value Ax.

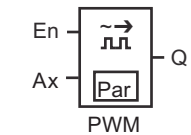
Symbol in IDEC SmartRelay	Wiring	Description
	Input En	A positive edge (0 to 1 transition) at input En enables the PWM function block.
	Input Ax	Analog signal to be modulated to a pulsed digital output signal.
	Parameter	A: gain Range of values: -10.00 to 10.00 B: zero offset Range of values: 10,000 to 10,000 T: periodic time over which the digital output is modulated p: number of decimals Range of values: 0, 1, 2, 3 Min: Range of values: -20,000 to 20,000 Max: Range of values: -20,000 to 20,000
	Output Q	Q is set or reset for the proportion of each time period according to the proportion of the standardized value Ax to the analog value range.

#### Parameter T

Note the defaults of the T parameters listed in topic Time response (Page 126).

The periodic time T can be provided by the actual value of another already-programmed function. You can use the actual value of the following functions:

- Analog comparator (Page 184) (actual value  $A_x - A_y$ )
- Analog trigger (Page 179) (actual value  $A_x$ )
- Analog amplifier (Page 192) (actual value  $A_x$ )
- Analog multiplexer (Page 210) (actual value  $AQ$ )
- Analog ramp control (Page 213) (actual value  $AQ$ )
- Analog Math (Page 225) (actual value  $AQ$ )
- PI controller (Page 217) (actual value  $AQ$ )
- Up/down counter (Page 169) (actual value  $Cnt$ )
- Analog filter (Page 230) (actual value  $AQ$ )
- Average value (Page 236) (actual value  $AQ$ )
- Max/Min (Page 232) (actual value  $AQ$ )
- On-delay (Page 134) (current time  $T_a$ )
- Off-delay (Page 137) (current time  $T_a$ )
- On-/off-delay (Page 139) (current time  $T_a$ )
- Retentive on-delay (Page 141) (current time  $T_a$ )
- Interval time-delay relay/Pulse output (Page 143) (current time  $T_a$ )
- Edge-triggered interval time-delay relay (Page 145) (current time  $T_a$ )
- Asynchronous pulse generator (Page 147) (current time  $T_a$ )
- Stairwell light switch (Page 151) (current time  $T_a$ )
- Dual-function switch (Page 153) (current time  $T_a$ )
- Stopwatch (Page 167) (actual value  $AQ$ )
- Frequency trigger (Page 176) (actual value  $Fre$ )

Select the required function by the block number. The timebase is configurable. For information on valid ranges and parameter defaults, refer to the On-delay (Page 134) topic.

### Parameters p (number of decimals)

Parameter p applies only to the display of the  $A_x$  value in a message text.

### Functional description

The function reads the value of the signal at the analog input  $A_x$ .

This value is multiplied by the value of parameter A (gain). Parameter B (offset) is added to the product, as follows:

$$(A_x \cdot \text{Gain}) + \text{Offset} = \text{Actual value } A_x$$

The function block calculates the proportion of the actual value  $A_x$  to the range. The block sets the digital output Q high for the same proportion of the T (periodic time) parameter, and sets Q low for the remainder of the time period.

**Examples with timing diagrams**

The following examples show how the PWM instruction modulates a digital output signal from the analog input value:

**Example 1**

Analog input value: 500 (range 0 to 1,000)

Periodic time T: four seconds

The digital output of the PWM function is 2 seconds high, 2 seconds low, 2 seconds high, 2 seconds low and continues in that pattern as long as parameter "En" = high.

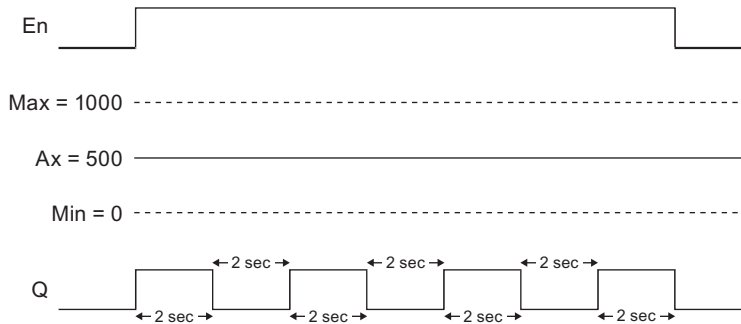

**Example 2**

Analog input value: 300 (range 0 to 1,000)

Periodic time T: 10 seconds

The digital output of the PWM function is three seconds high, seven seconds low, three seconds high, seven seconds low and continues in that pattern as long as parameter "En" = high.

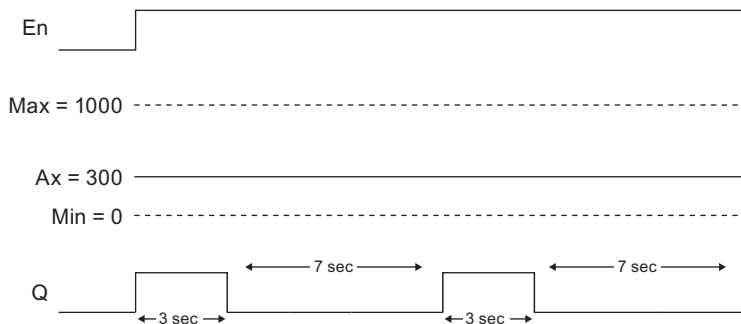

**Calculation rule**

$Q = 1$ , for  $(Ax - Min) / (Max - Min)$  of time period T, when  $Min < Ax < Max$ .  
 $Q = 0$ , for  $PT - [(Ax - Min) / (Max - Min)]$  of periodic time T.

**Note:** Ax in this calculation refers to the actual value Ax as calculated using the Gain and Offset.

### Setting the Par Parameter

The following illustration shows the view in programming mode that corresponds to the first example:



View in parameter assignment mode:



## 4.4.32 Analog Math

### Short description

The analog math block calculates the value AQ of an equation formed from the user-defined operands and operators.

Symbol in IDEC SmartRelay	Wiring	Description
<p>En — [ + = A → ] — AQ [ Par ] Analog Math</p>	Input En	A change in the status from 0 to 1 at input En (Enable) enables the analog math function block.
	Parameter	<b>V1:</b> first operand value <b>V2:</b> second operand value <b>V3:</b> third operand value <b>V4:</b> fourth operand value  <b>Op1:</b> first operator <b>Op2:</b> second operator <b>Op3:</b> third operator  <b>Operator Prio:</b> priority of the operands  <b>Qen → 0:</b> 0: reset value of AQ to 0 when En=0 1: retain last value of AQ when En=0 <b>p:</b> number of decimals Range of values: 0, 1, 2, 3
	Output AQ	The output AQ is the result of the equation formed from the operand values and operators. AQ will be set to 32767 if a divide by 0 or overflow occurs, and -32768 if a negative overflow (underflow) occurs.

## Parameters V1 to V4

Another already-programmed function can provide the analog values for the parameters V1 to V4. You can use the actual values of the following functions:

- Analog comparator (Page 184) (actual value Ax – Ay)
- Analog trigger (Page 179) (actual value Ax)
- Analog amplifier (Page 192) (actual value Ax)
- Analog multiplexer (Page 210) (actual value AQ)
- Analog ramp control (Page 213) (actual value AQ)
- PI controller (Page 217) (actual value AQ)
- Up/down counter (Page 169) (actual value Cnt)
- Analog filter (Page 230) (actual value AQ)
- Average value (Page 236) (actual value AQ)
- Max/Min (Page 232) (actual value AQ)
- On-delay (Page 134) (current time Ta)
- Off-delay (Page 137) (current time Ta)
- On-/off-delay (Page 139) (current time Ta)
- Retentive on-delay (Page 141) (current time Ta)
- Interval time-delay relay/Pulse output (Page 143) (current time Ta)
- Edge-triggered interval time-delay relay (Page 145) (current time Ta)
- Asynchronous pulse generator (Page 147) (current time Ta)
- Stairwell light switch (Page 151) (current time Ta)
- Dual-function switch (Page 153) (current time Ta)
- Stopwatch (Page 167) (actual value AQ)
- Analog math (actual value AQ)
- Frequency trigger (Page 176) (actual value Fre)

Select the required function by the block number. For information on parameter defaults, refer to the On-delay (Page 134) topic.

---

### Note

If the analog value for parameter V1, V2, V3 or V4 is derived from another already-programmed function whose actual value exceeds the value range for V1 to V4, IDEC SmartRelay will display the limit value -32768 if the value is less than the lower range or 32767 if the value is greater than the upper range.

---

## Parameters p (number of decimals)

Parameter p applies only to the display of Value1, Value2, Value3, Value4 and AQ in a message text.

## Functional description

The analog math function combines the four operations and three operators to form an equation. The operator can be any one of the four standard operators: +, -, \*, or /. The priority of operators is determined by "(" and "[ ]", in which "(" has a higher priority. The operand values can reference another previously-defined function to provide the value. The analog math function rounds the result to the nearest integer value.

The number of operand values is fixed at four and the number of operators is fixed at 3. If you need to use fewer operands, use constructions such as + 0 or \* 1 to fill the remaining parameters.

You can also configure the behavior of the function when the Enable parameter En=0. The function block can either retain its last value, or be set to 0. If the parameter Qen → 0 = 0, then the function sets AQ to 0 when En=0. If the parameter Qen → 0 = 1, then the function leaves AQ at its last value when En=0.

## Possible errors: zero division and overflow

If the analog math function block execution results in zero division or overflow, it sets internal bits that indicate the type of error that occurred. You can program an analog math error detection function block in your circuit program to detect these errors, and to control the program behavior as needed. You program one analog math error detection function block to reference one specific analog math function block.

## Examples

The following tables show some simple example analog math block parameters, and the resulting equations and output values:

V1	Op1 (Priority)	V2	Op2 (Priority)	V3	Op3 (Priority)	V4
12	[+]	6	(/)	3	-	1

**Equation:**  $[12 + (6 / 3)] - 1$

**Result:** 13

V1	Op1 (Priority)	V2	Op2 (Priority)	V3	Op3 (Priority)	V4
2	+	3	[*]	1	(+)	4

**Equation:**  $2 + [3 * (1 + 4)]$

**Result:** 17

V1	Op1 (Priority)	V2	Op2 (Priority)	V3	Op3 (Priority)	V4
100	(-)	25	/	2	[+]	1

**Equation:**  $(100 - 25) / [2 + 1]$

**Result:** 25

### Setting the Par parameter

The following illustration shows the view in programming mode that corresponds to the first example  $[12 + (6 / 3)] - 1$ :

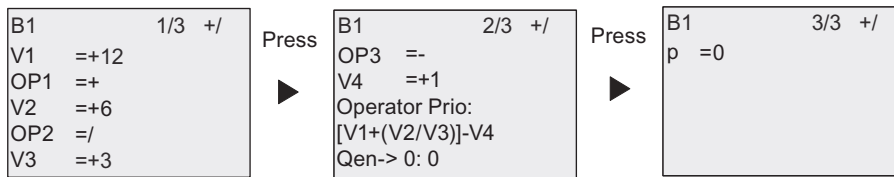

View in parameter assignment mode:

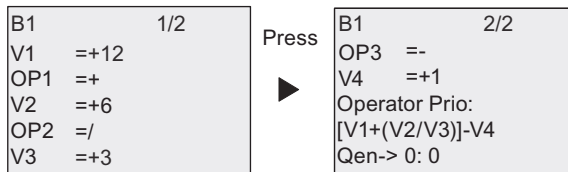

### 4.4.33 Analog Math error detection

#### Short description

The analog math error detection block sets an output if an error has occurred in the referenced Analog Math (Page 225) function block.

Symbol in IDEC SmartRelay	Wiring	Description
<p>AnalogMath Error</p>	Input En	A change in the status from 0 to 1 at input En (Enable) enables the analog math error detection block.
	Input R	A signal at input R resets the output.
	Parameter	MathBN: block number of an analog math Err: ZD: divide by 0 error OF: overflow error ZD/OF: (divide by 0 error) OR (overflow error) AutoRst: reset the output before the next execution of the analog math error function block. Y = yes; N = no
	Output Q	Q is set high if the error to detect occurred in the last execution referenced analog math function block.

#### Parameter MathBN

The value for the MathBN parameter references the block number of an already-programmed analog math function block.

## Functional description

The analog math error detection block sets the output when the referenced analog math function block has an error. You can program the function to set the output on a zero division error, an overflow error, or when either type of error occurs.

If AutoRst is set, the output is reset prior to the next execution of the function block. If AutoRst is not set, then whenever the output is set it remains set until the analog math error detection block is reset with the R parameter. In this way, even if the error subsequently clears, the circuit program still has knowledge that an error did occur at some point.

In any scan cycle, if the referenced analog math function block executes before the analog math error detection function block, the error is detected in the same scan cycle. If the referenced analog math function block executes after the analog math error detection function block, the error is detected in the next scan cycle.

## Analog math error detection logic table

In the table below, Err represents the parameter of the analog math error detection instruction that selects which type of error to detect. ZD represents the zero division bit set by the analog math at the end of its execution: 1 if the error occurred, 0 if not. OF represents the overflow bit set by the analog math: 1 if the error occurred, 0 if not. The ZD/OF Err parameter represents the logical OR of the zero division bit and overflow bit of the referenced analog math instruction. Q represents the output of the analog math error detection function. An "x" indicates that the bit can be either 0 or 1 with no influence on the output.

Err	ZD	OF	Q
ZD	1	x	1
ZD	0	x	0
OF	x	1	1
OF	x	0	0
ZD/OF	1	0	1
ZD/OF	0	1	1
ZD/OF	1	1	1
ZD/OF	0	0	0

If the MathBN parameter is null, then the output Q is always 0.



### Setting the Par parameter

The parameters MathBN, AutoRst, and Err can be set in programming mode or parameter assignment mode.

View in programming mode (example):

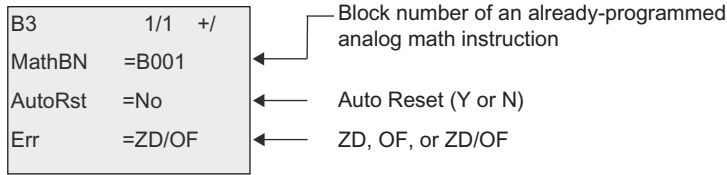

View in parameter assignment mode (example):

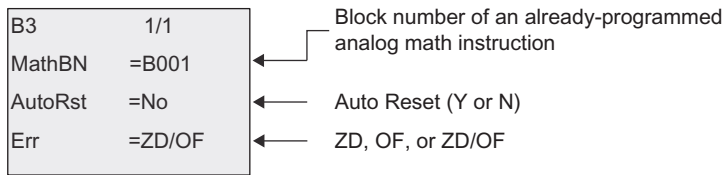

### 4.4.34 Analog filter

#### Short description

The analog filter function smooths the analog input signal.

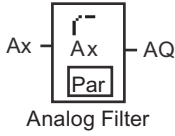
Symbol in IDEC SmartRelay	Wiring	Description
 <p>Analogue Filter</p>	Ax	Input Ax is the analog input signal to be smoothed. Input Ax is one of the following analog signals: <ul style="list-style-type: none"> <li>• AI1 to AI8 (*)</li> <li>• AM1 to AM64</li> <li>• NAI1 to NAI32</li> <li>• AQ1 to AQ8</li> <li>• NAQ1 to NAQ16</li> <li>• Block number of a function with analog output</li> </ul>
	Parameter	<b>Sn</b> (Number of samples) determines how many analog values are sampled within the program cycles that are determined by the set number of samples. IDEC SmartRelay samples an analog value within every program cycle. The number of program cycles is equal to the set number of samples. Possible settings: 8, 16, 32, 64, 128, 256
	Output AQ	AQ is the average value of input Ax over the current number of samples.
* AI1 to AI8: 0 V to 10 V corresponds with 0 to 1000 (internal value).		

### Timing diagram (example)

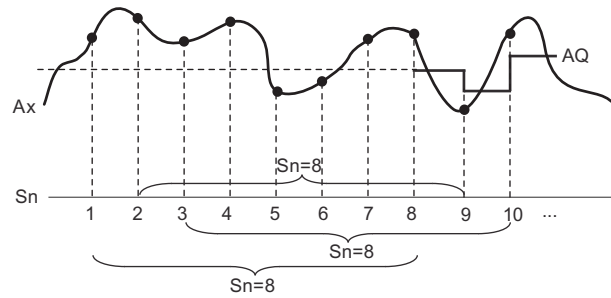

### Functional description

The function fetches the analog signal at input  $A_x$  based on the set number of samples ( $S_n$ ) and outputs the average value.

#### Note

There are a maximum of eight analog filter function blocks available for use in the circuit program in IDEC SmartRelay.

### Setting the Par parameter

View in programming mode (example):

B20	1/1	+/	← Protection mode
$S_n$	=128		← Number of samples

View in parameter assignment mode (example):

B20	1/1
$S_n$	=128
AQ	=+0

### 4.4.35 Max/Min

#### Short description

The Max/Min function records the maximum or minimum value of Ax.

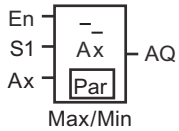
Symbol in IEEC SmartRelay	Wiring	Description
	En	A signal at input En (Enable) outputs an analog value to AQ, depending on the settings of parameters ERst and Mode.
	S1	S1 functions only when the parameter Mode is set to 2. If Mode is set to 2, a change in status from 0 to 1 at input S1 (selector) outputs the maximum value to AQ. If Mode is set to 2, a change in status from 1 to 0 at S1 outputs the minimum value to AQ.
	Ax	Input Ax is one of the following analog signals: <ul style="list-style-type: none"> <li>• AI1 to AI8 (*)</li> <li>• AM1 to AM64</li> <li>• NAI1 to NAI32</li> <li>• AQ1 to AQ8</li> <li>• NAQ1 to NAQ16</li> <li>• Block number of a function with analog output</li> </ul>
	Parameter	<b>Mode:</b> Possible settings: 0, 1, 2, 3 Mode = 0: AQ = Min Mode = 1: AQ = Max Mode = 2 and S1= 0 (low): AQ = Min Mode = 2 and S1= 1 (high): AQ = Max Mode = 3: AQ = Actual value of Ax <b>ERst (Enable Reset):</b> Possible settings: ERst = 0: disable reset ERst = 1: enable reset Retentivity: / = no retentivity R = the status is retentive
Output AQ	The function issues a minimum, maximum, or current value at AQ, depending on your configuration.	
* AI1 to AI8: 0 V to 10 V corresponds with 0 to 1000 (internal value).		

## Parameter Mode

The actual value of another already-programmed function can provide the value for parameter Mode. You can use the actual values of the following functions:

- Analog comparator (Page 184) (actual value  $Ax - Ay$ )
- Analog trigger (Page 179) (actual value  $Ax$ )
- Analog amplifier (Page 192) (actual value  $Ax$ )
- Analog multiplexer (Page 210) (actual value  $AQ$ )
- Analog ramp control (Page 213) (actual value  $AQ$ )
- Analog Math (Page 225) (actual value  $AQ$ )
- PI controller (Page 217) (actual value  $AQ$ )
- Up/down counter (Page 169) (actual value  $Cnt$ )
- Analog filter (Page 230) (actual value  $AQ$ )
- Average value (Page 236) (actual value  $AQ$ )
- On-delay (Page 134) (current time  $Ta$ )
- Off-delay (Page 137) (current time  $Ta$ )
- On-/off-delay (Page 139) (current time  $Ta$ )
- Retentive on-delay (Page 141) (current time  $Ta$ )
- Interval time-delay relay/Pulse output (Page 143) (current time  $Ta$ )
- Edge-triggered interval time-delay relay (Page 145) (current time  $Ta$ )
- Asynchronous pulse generator (Page 147) (current time  $Ta$ )
- Stairwell light switch (Page 151) (current time  $Ta$ )
- Dual-function switch (Page 153) (current time  $Ta$ )
- Stopwatch (Page 167) (actual value  $AQ$ )
- Max/Min (actual value  $AQ$ )
- Frequency trigger (Page 176) (actual value  $Fre$ )

Select the required function by the block number.

**Timing diagram (example)**

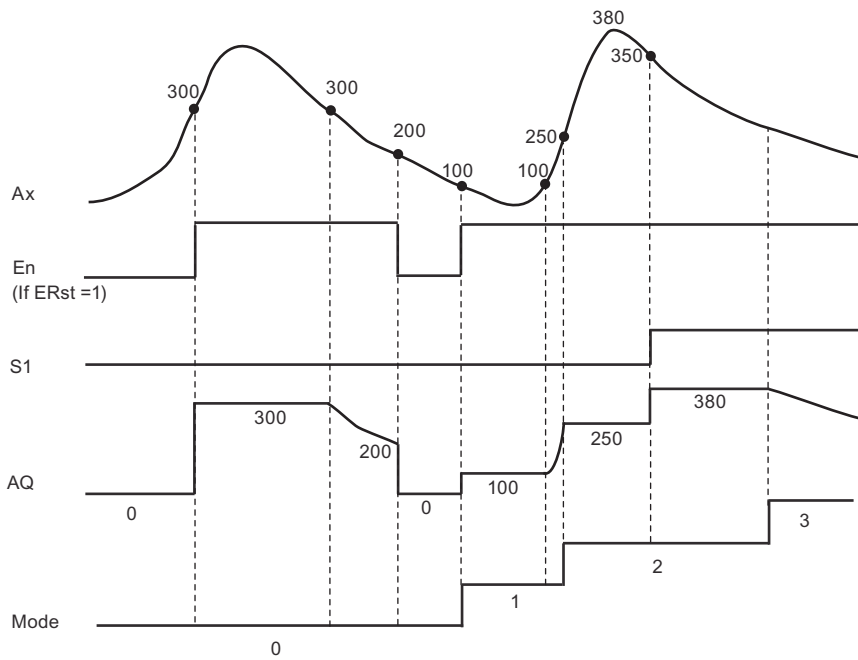

**Functional description**

ERst = 1 and En = 0: the function sets the AQ value to 0.

ERst = 1 and En = 1: the function outputs a value at AQ, depending on the settings of Mode and S1.

ERst = 0 and En = 0: the function holds the value of AQ at the current value.

ERst = 0 and En = 1: the function outputs a value at AQ, depending on the settings of Mode and S1.

Mode = 0: the function sets AQ to the minimum value

Mode = 1: the function sets AQ to the maximum value

Mode = 2 and S1 = 0: the function sets AQ to the minimum value

Mode = 2 and S1 = 1: the function sets AQ to the maximum value

Mode = 3: the function outputs current analog input value.

## Setting the Par parameter

View in programming mode (example)

B37	1/1	+/	← Protection mode and retentivity
Mode	=2		← Number of samples
Erst	=1		← Enable reset

View in parameter assignment mode (example)

B37	1/1
Mode	=2
Min	=+0
Max	=+0
Erst	=1
AQ	=+0

### 4.4.36 Average value

#### Short description

The average value function calculates the average value of an analog input over a configured time period.

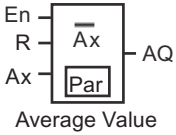
Symbol in IDEC SmartRelay	Wiring	Description
 <p>Average Value</p>	En	<p>A change in status from 0 to 1 transition at input En starts the average value function.</p> <p>A change in status from 1 to 0 at input En holds the analog output value.</p>
	R	A signal at input R clears the analog output value.
	Ax	<p>Input Ax is one of the following analog signals:</p> <ul style="list-style-type: none"> <li>• AI1 to AI8 (*)</li> <li>• AM1 to AM64</li> <li>• NAI1 to NAI32</li> <li>• AQ1 to AQ8</li> <li>• NAQ1 to NAQ16</li> <li>• Block number of a function with analog output</li> </ul>
	Parameter	<p><b>St</b> (Sampling time): you can set the timebase to s (seconds), d (days), h (hours), or m (minutes).                      Range of values:                      St = s: 1 to 59                      St = d: 1 to 365                      St = h: 1 to 23                      St = m: 1 to 59</p> <p><b>Sn</b> (Number of samples):                      Range of values:                      St = s: 1 to St*100                      St = d: 1 to 32767                      St = h: 1 to 32767                      St = m and St ≤ 5 minutes: 1 to St*6000                      St = m and St ≥ 6 minutes: 1 to 32767</p> <p>Retentivity:                      / = no retentivity                      R = retentivity</p>
Output AQ	Outputs the average value of input Ax over configured time sampling period.	
<p>* AI1 to AI8: 0 V to 10 V corresponds with 0 to 1000 (internal value).</p>		

### Timing diagram (example)

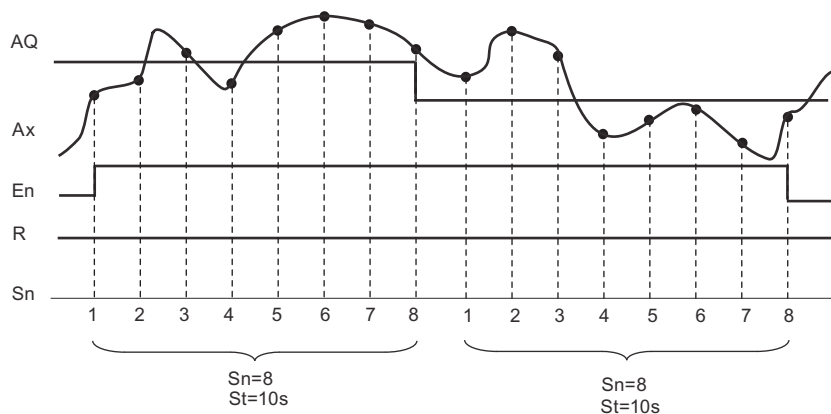

### Functional description

This function fetches the analog input signal according to both the set sampling time  $St$  and the number of samples  $Sn$  and outputs the average value. A signal at R sets AQ to 0.

### Setting the Par parameter

View in programming mode (example):

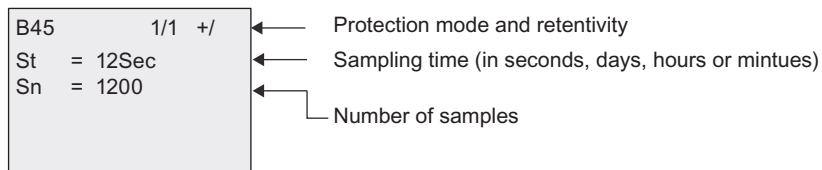



### 4.4.37 Float/Integer Converter

#### Short description

IEEC SmartRelay only can deal with integer. If you transfer some float from outer system by network with FL1F/Modbus protocol, IEEC SmartRelay cannot deal with it directly. With this Float /Integer Converter function block, you can convert a float to integer by dividing a resolution in the range of values, and then the IEEC SmartRelay can process the logic with this integer. If required, use Integer/Float Converter to convert the result into float and store it in the VM; and transfer the float to outer system with FL1F/Modbus protocol. You need to set a suitable resolution for the input float in the parameter setting.

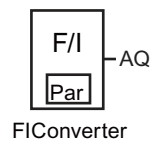
Symbol in IEEC SmartRelay	Wiring	Description
 <p>FIConverter</p>	Parameter	<ul style="list-style-type: none"> <li>Typ. : It specifies the type of input data.                             <ul style="list-style-type: none"> <li>Float: it is a 32 bits single-precision float number;</li> <li>Double: it is a 64 bits double-precision float number.</li> </ul> </li> <li>VM. : Variable Memory Address, starting address of float or double stored in VM. Range of values:                             <ul style="list-style-type: none"> <li>For Float: 0-847</li> <li>For Double: 0-843</li> </ul> </li> <li>Res. : Resolution, it's a divider for output value. Range of values: 0.001 to 1000</li> </ul>
	Extended analog output <b>eAQ</b>	Extended analog output for programming via parameter reference. <ul style="list-style-type: none"> <li>Used as a reference parameter of the other function block.</li> <li>Signed 32 bits value.</li> <li>Range of values: -999,999,999 to 999,999,999.</li> </ul>
	Output <b>AQ</b>	AQ is the analog output value. It has the following features. <ul style="list-style-type: none"> <li>Used as input value of the other function block.</li> <li>Signed 16 bit value.</li> <li>Range of values: -32768 to 32767.</li> </ul>

## Functional description

You usually need both the blocks Float/Integer converter and Integer/Float converter to complete a task. A typical way to use these function blocks is:

1. Transfer the floats from outer system by network (with FL1F/Modbus protocol) and store them in VM.
2. Convert the floats stored in VM to integer by Float/Integer converter.
3. Process the integer with IDEC SmartRelay BM.
4. Convert the result to floats by Integer/Float and store them in the VM.
5. Transfer the floats to outer system (with FL1F/Modbus protocol).

## Calculation rule

Define  $Q = \text{Data Input} / \text{Resolution}$

### Analog output (AQ)

- if  $-32768 \leq Q \leq 32767$ , the Analog output =  $Q$ .
- if the  $Q \geq 32767$ , then Analog output = 32767.
- if the  $Q \leq -32768$ , then Analog output = -32768.

### Extended analog output (eAq)

- if  $-999,999,999 \leq Q \leq 999,999,999$ , the Extended analog output =  $Q$ .
- if the  $Q \geq 999,999,999$ , then Extended analog output = 999,999,999.
- if the  $Q \leq -999,999,999$ , then Extended analog output = -999,999,999.

## Setting the Par parameter

View in programming mode (example):

B1	1/1	
Typ.	=Float	← The type for the input
VM.	=0	← Variable Memory Address
Res.	=0.100	← Resolution

View in parameter assignment mode (example)

B1	1/1	
Typ.	=Float	← The type for the input
VM.	=0	← Variable Memory Address
Res.	=0.100	← Resolution
eAq	=0	← Extended analog output
Aq	=0	← Analog output

### 4.4.38 Integer/Float Converter

#### Short description

IDEC SmartRelay only can deal with integer. If you transfer some float from outer system by network with FL1F/Modbus protocol, IDEC SmartRelay cannot deal with it directly. With this Integer/Float Converter function block, you can convert an integer to float by multiplying a resolution in the range of values, and stored it in VM, then you can transfer this result to the outer system through network. You need to set a suitable resolution for the output float in the parameter setting.

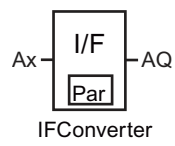
Symbol in IDEC SmartRelay	Wiring	Description
	Input <b>Ax</b>	Input Ax is one of the following analog signals: <ul style="list-style-type: none"> <li>• AI1 to AI8 (*)</li> <li>• AM1 to AM16, or AM1 to AM64 (if FL1F)</li> <li>• NAI1 to NAI32</li> <li>• AQ1 to AQ2, or AQ1 to AQ8 (if FL1F)</li> <li>• NAQ1 to NAQ16</li> <li>• Block number of a function with analog output</li> </ul>
	Parameter	<ul style="list-style-type: none"> <li>• Typ. : It specifies the type of output data.                             <ul style="list-style-type: none"> <li>– Float: it is a 32 bits single-precision float number;</li> <li>– Double: it is a 64 bits double-precision float number.</li> </ul> </li> <li>• VM. : Variable Memory Address, starting address of float or double stored in VM:                             <ul style="list-style-type: none"> <li>– For Float: 0-847</li> <li>– For Double: 0-843</li> </ul> </li> <li>• Res. : Resolution, it's a multiplier for output value. Range of values: 0.001 to 1000</li> </ul>
	Extended analog input <b>eAx</b>	If the analog input (Ax) is not available, you can assign a value to Extended analog input (eAQ) by inputting a value to the eAx field or referring to other FB's parameter. Range of values: -999,999,999 to 999,999,999
	Extended analog output <b>eAQ</b>	Extended analog output for programming through parameter reference. <ul style="list-style-type: none"> <li>• Used as a reference parameter of the other function block.</li> <li>• Signed 32 bits value.</li> <li>• Range of values: -999,999,999 to 999,999,999.</li> </ul>
	Output <b>AQ</b>	AQ is the analog output value. It has the following features. <ul style="list-style-type: none"> <li>• Used as input value of the other function block.</li> <li>• Signed 16 bit value.</li> <li>• Range of values: -32768 to 32767.</li> </ul>
* AI1 to AI8: 0 V to 10 V corresponds with 0 to 1000 (internal value).		

## Functional description

You usually need both the blocks Float/Integer converter and Integer/Float converter to complete a task. A typical way to use these function blocks is:

1. Transfer the floats from outer system by network (with FL1F/Modbus protocol) and store them in VM.
2. Convert the floats stored in VM to integer by Float/Integer converter.
3. Process the integer with IEEC SmartRelay BM.
4. Convert the result to floats by Integer/Float and store them in the VM.
5. Transfer the floats to outer system (with FL1F/Modbus protocol).

## Calculation rule

### Float Value in VM address

Float Value in VM address = Analog input x Resolution

### Analog output (AQ)

- Analog input connector is connected: Analog output = Analog input
- Analog input connector isn't connected:
  - if  $-32768 \leq \text{Extended analog input} \leq 32767$ , the Analog output = Extended analog input.
  - if the Analog input  $\geq 32767$ , then Analog output = 32767.
  - if the Analog input  $\leq -32768$ , then Analog output = -32768.

### Extended analog output (eAq)

- If the analog input connector is connected: Extended analog input = analog input.
- Extended analog input connector isn't connected:
  - if  $-999,999,999 \leq \text{Extended analog input} \leq 999,999,999$ , the Extended Analog Output = Extended analog input.
  - if the Extended analog input  $\geq 999,999,999$ , then Extended analog output = 999,999,999.
  - if the Extended analog input  $\leq -999,999,999$ , then Extended analog output = -999,999,999.

### Setting the Par parameter

View in programming mode (example):

B1	1/2	
Typ.	=Float	← The type for the input
VM.	=0	← Variable Memory Address
Res.	=0.100	← Resolution
eAx	=0	← Extended analog input

View in parameter assignment mode (example)

B1	1/2	
Typ.	=Float	← The type for the input
VM.	=0	← Variable Memory Address
Res.	=0.100	← Resolution
eAx	=0	← Extended analog input
eAq	=0	← Extended analog output

B1	2/2	
Aq	=0	← Analog output

## Web server

IDEC SmartRelay has a built-in Web server which enables you to operate the Base Module or the Text Display from a traditional PC or a mobile device.

In this approach, you can access the Base Module or the Text Display using a connected device (conventional PC, tablet or smart phone with Web browsing capabilities) through its IP address.

The Web server allows you to use the mouse pointer or the touch screen, depending on the device you are using, to perform fast and easy operations on the virtualized Base Module and Text Display.

For detailed information about security functions on IDEC SmartRelay, see Chapter Security (Page 281).

### 5.1 Enabling the Web server

Make sure you have connected your PC or mobile device to the desired Base Module or Text Display, and guarantee you have enabled the Web user access in WindLGC according to instructions in the user profile settings of the Online Help for WindLGC.

#### Supported network explorers

The IDEC SmartRelay Web server supports the following Web browsers:

- Microsoft Internet Explorer with minimum version 8.0
- Mozilla Firefox with minimum version 11.0
- Google Chrome with minimum version 16.0
- Apple Safari with minimum version 5.0
- Opera with minimum version 12.0

---

**Note**

Make sure you do not disable cookies on your browser.

---

### Supported devices

The IDEC SmartRelay Web server supports the following communications devices when you use one of the above explorers:

- Conventional PC
- Apple iPhone series
- Apple iPad series
- Smart phones and tablets with Android system with minimum version Android 2.0

### Supported Web page language

The IDEC SmartRelay Web server supports the following Web page languages:

- German
- English
- Italian
- French
- Spanish
- Chinese Simplified
- Japanese

## 5.2 Logging on to the Web server

Follow the steps below to log on to the desired Base Module.

1. Open your Web browser.
2. Enter the IP address of your Base Module in the IP address bar.
  - LAN (Local Area Network) access:

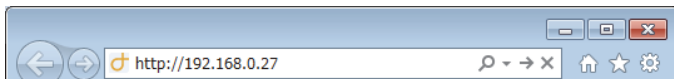

- Remote access:



---

#### Note

Make sure you have enabled TCP port 8080 for remote access.

---

- Click or tap the  button. The IDEC SmartRelay Web server redirects you to the welcome page.

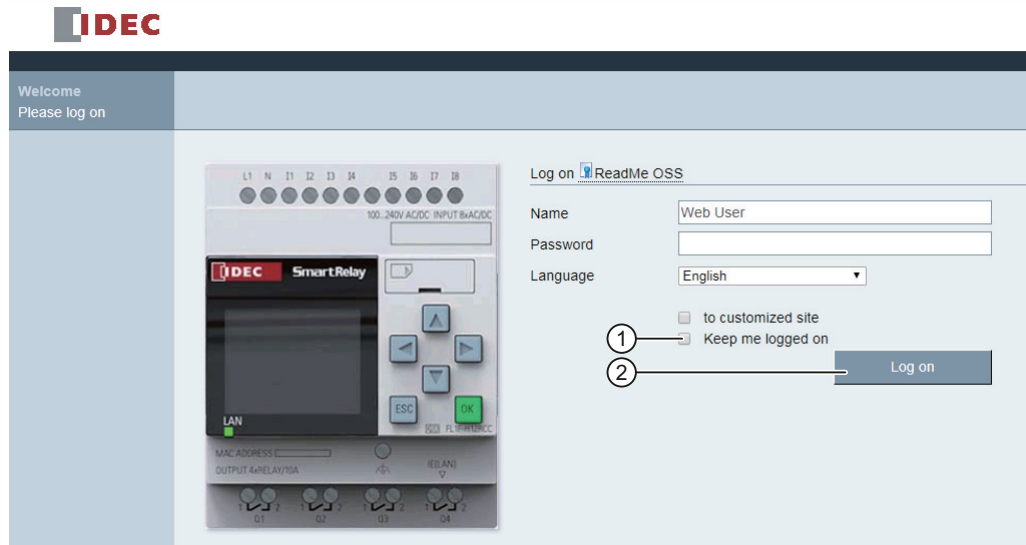

#### Note

If you have enabled Web user access without changing the password, you can log on with the default password "IDEC".

- Select an appropriate language from the drop-down menu if needed.

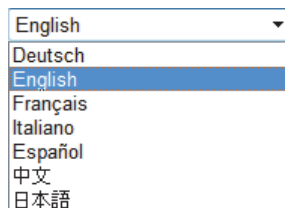

- Enter the password.

#### Note

- You can only enable the Web server access or change the logon password using WindLGC. For more information about setting the user password, refer to the Online Help for WindLGC.
- If you do not desire to enter the user name and password again at the next logon, you can select the " ① " check box. Make sure you do not set your browser to private mode, since your browser does not record any browsing history or passwords in this mode.
- You can access one Base Module from multiple IDEC SmartRelay Web server clients, but due to memory usage, this might also impact the performance of the connected Base Module.

- Click or tap " ② " to log on to the Web server.

#### Note

- For remote access, the logon may take several seconds.
- If your logon fails, press or tap the refresh button on your browser (or press the keyboard shortcut "F5" on the conventional PC) to try it again.



## 5.3 Viewing IDEC SmartRelay system information

Once logged in, the IDEC SmartRelay Web server displays all the system information of the IDEC SmartRelay Base Module including module generation, module type, firmware (FW) version, IP address, and module status.

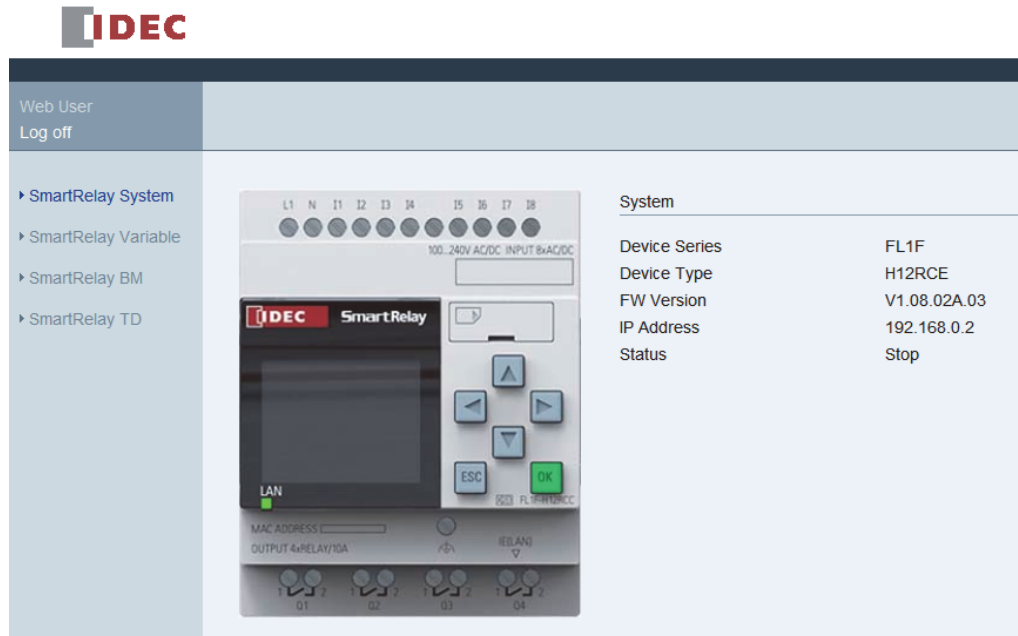

### Note

The firmware version in the above screen is listed for an example, your IDEC SmartRelay device may be of a later version.

## 5.4 Operating the virtual module on the Web server

The IDEC SmartRelay Web server enables you to do the following operations on the virtual Base Module through **SmartRelay BM** menu and the virtual Text Display through **SmartRelay TD** menu.

### Operating the keys on the virtual module

If you have previously programmed the cursor keys and function keys in your circuit program, you can perform the following basic operations with these keys on the virtual Base Module or Text Display:

To enable the functionality of the programmed cursor, click or tap the **ESC** key. Function keys are always enabled.

You can then proceed as follows:

- To enable pulse inputs, click or tap the cursor key or function key concerned.
- To enable continuous high-level signal input, continue to click the cursor keys or function key, if you release the button, the high-level signal will be lost.
- To disable the programmed cursor key or function key, click or tap the **ESC** key again.
- To disable the display of an active message as long as this message has been previously configured in WindLGC as acknowledgeable, click or tap the **OK** key.

### Viewing message text

If you have configured your message text on WindLGC according to the instructions in the Online Help for WindLGC, you are then able to see them on the virtual screen of the module.

Click or tap **SmartRelay BM** or **SmartRelay TD** on the left navigation bar and you can view active messages on the virtual device.

- On the Base Module:

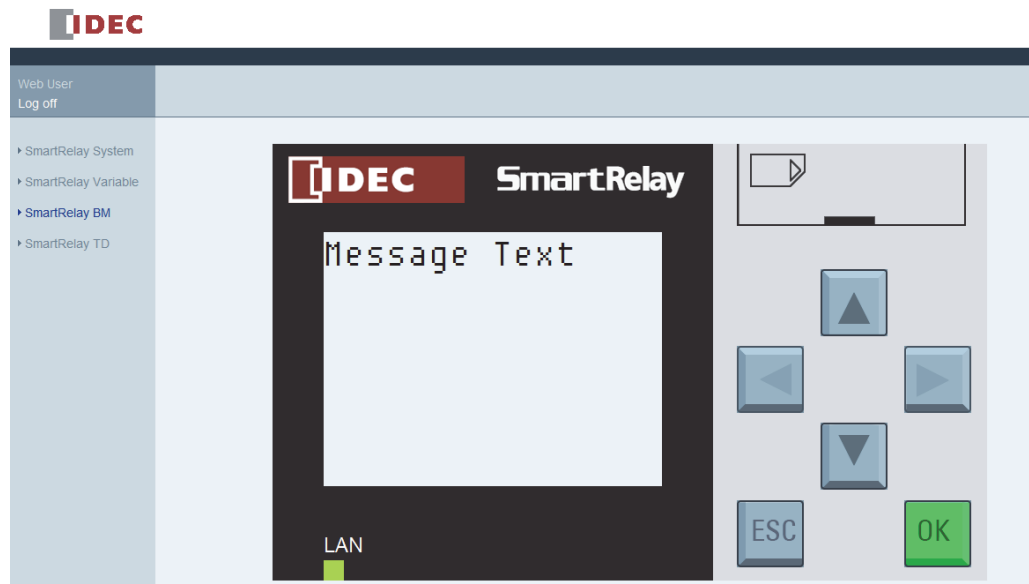

- On the Text Display:



You can click or tap ▲ or ▼ to tick manually for available messages.

---

**Note**

The ◀ and ▶ are gray, indicating they are not applicable in viewing message texts.

---

### Viewing message text ticking

If you have configured message ticking settings on WindLGC according to the instructions in the Online Help for WindLGC, you can see the message text ticking by lines or characters on the virtual Base Module or Text Display.

### Checking backlight color status

If you have configured backlight color settings on WindLGC according to the instructions in the Online Help for WindLGC, you can see the same backlight effect displayed on the virtual Base Module or Text Display.

### Setting the configurable parameters

If you have configured to show certain parameters on Base Module or Text Display according to the instructions in the Online Help for WindLGC, you can see them displayed on the screen.

Double-click or double-tap on the displayed parameter to activate the parameter modification dialog. A parameter is grayed out when it is not editable.

- On the Base Module:

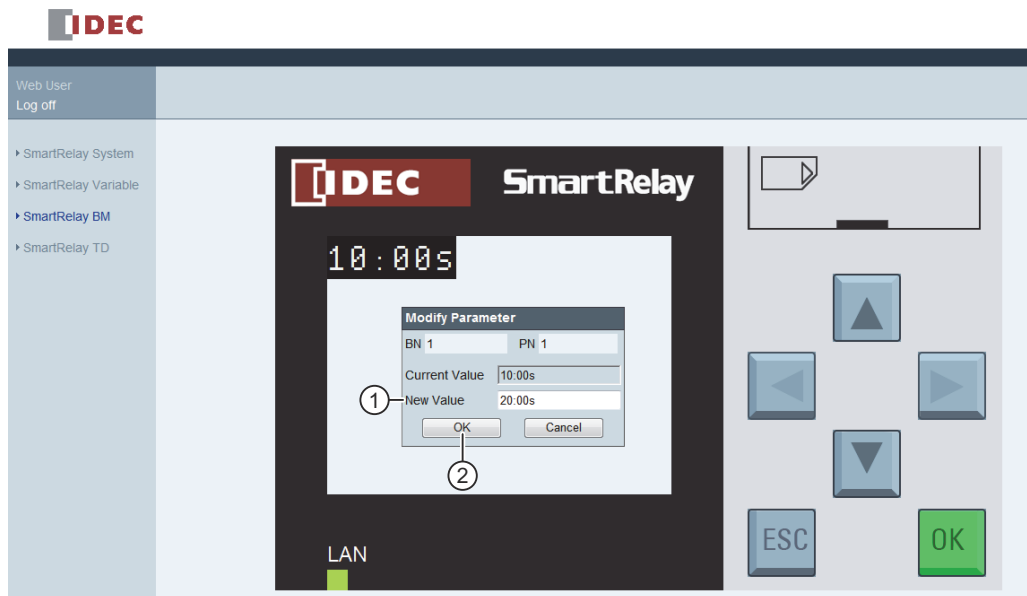

- On the Text Display:

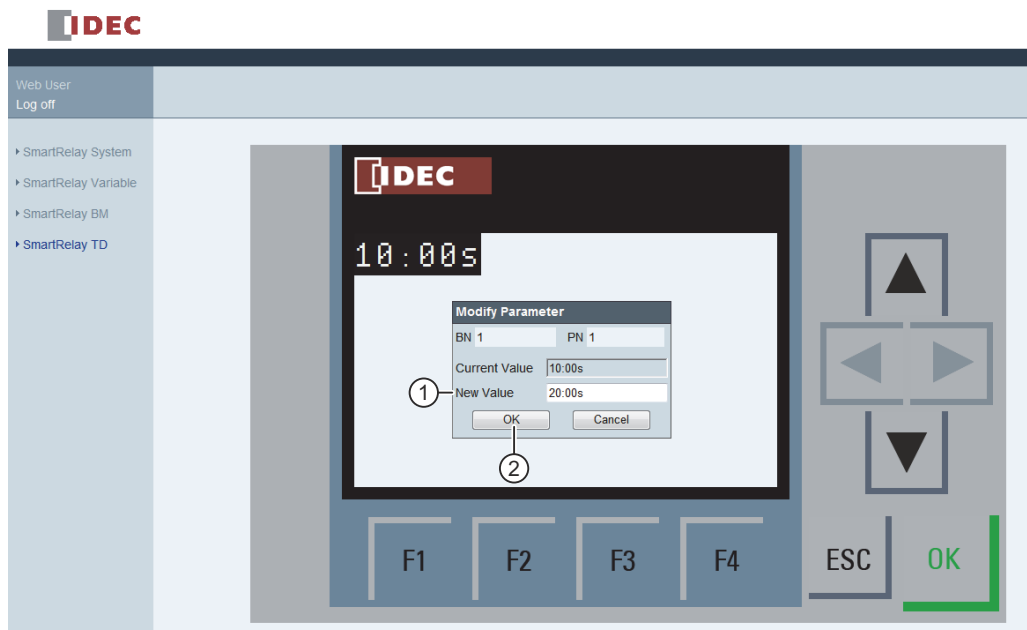

Enter the desired parameter value in line " ① " on the above screens. In this example, enter "20:00s".

Make sure you have strictly followed the example of your current value. Any inconsistency may cause errors on the module.

Click or tap " ② ". The updated parameter is displayed.

- On the Base Module:

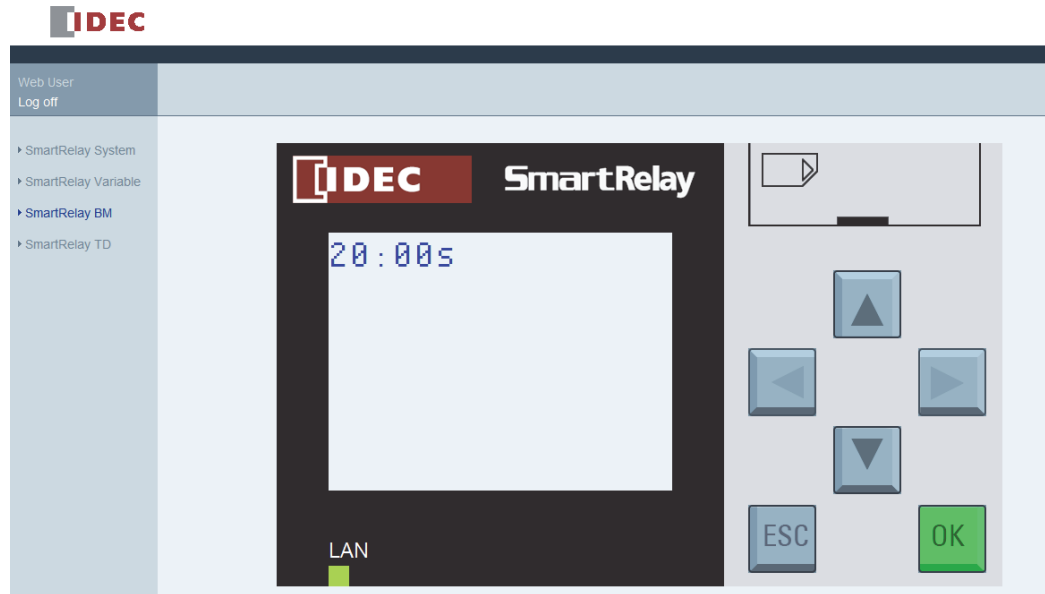

- On the Text Display:

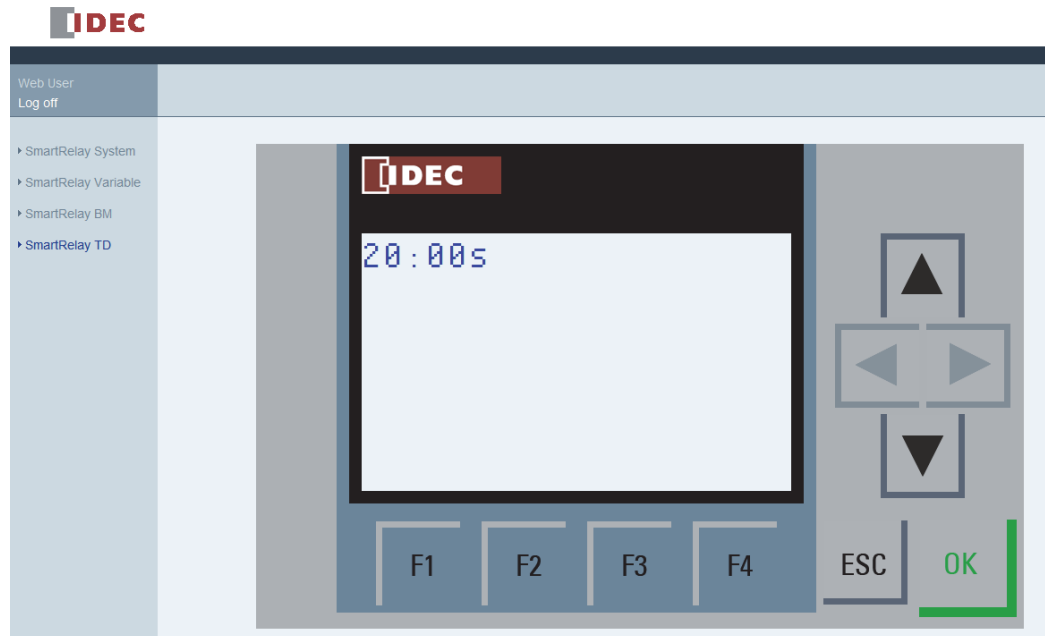

## 5.5 Viewing and editing variable memory tables

The IDEC SmartRelay Web server allows you to check and modify variable memory tables on the Web browser.

For complete description on the IDEC SmartRelay variables, refer to the "Parameter VM mapping" section of the Online Help for WindLGC.

Click or tap " ① " on the left navigation bar to show the variable table.

Del	Range	Address	Type	Display Format	Value	ModValue	Modify
X	CURS KEY	UP	BIT	BOOL	false		<input checked="" type="checkbox"/>
X	CURS KEY	DOWN	BIT	BOOL	false		<input checked="" type="checkbox"/>
X	CURS KEY	LEFT	BIT	BOOL	false		<input checked="" type="checkbox"/>
X	CURS KEY	RIGHT	BIT	BOOL	false		<input checked="" type="checkbox"/>
X	NetAQ	NetAQ1	WORD	SIGNED	0		<input checked="" type="checkbox"/>

Click or tap " ② " to add a new variable. Follow the steps below to set the variable.

1. Choose a desired range. Web server displays the mapping address, variable type, display format of the range.
2. Enter the new mapping address in the added empty column " ③ ".

The  indicates the variable is to be modified.

The  indicates it is not editable.

Click or tap " ④ " to apply the new mapping addresses.

## 5.6 Logging off from the Web server

To log off from the Web server, click or tap the button on top of the left navigation bar .

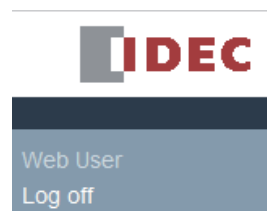



## UDF (User-Defined Function)

### User-Defined Function (UDF)

WindLGC provides you with a UDF (User-Defined Function) editor for creating circuit programs. You can save circuit programs created in the UDF editor as individual UDF blocks for use in a circuit program in the UDF or FBD editor.

A UDF block is a preconfigured circuit program that you create. You can add it to an existing circuit program as you do with a function block. If the circuit program in WindLGC already contains a UDF, after transferring the program from WindLGC to an IDEC SmartRelay, you can edit the elements connected to this UDF from the module.

For a detailed description of the UDF configuration in WindLGC, refer to the Online Help for WindLGC.

### Editing elements connected to a UDF block

You can neither create a UDF block from IDEC SmartRelay, nor edit the members of the block. You can only edit elements connected to the inputs or outputs of a UDF block or edit its parameter settings.

---

#### Note

Each UDF block has a maximum of eight inputs and four outputs, dependent upon your configuration in WindLGC.

---

#### Editing elements to the inputs of a UDF block

1. Switch IDEC SmartRelay to programming mode.

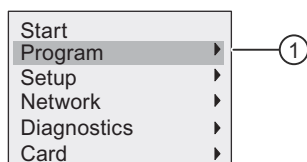

2. Select " ① " on the main menu: Press ▲ or ▼.
3. Confirm " ① ": Press **OK**.

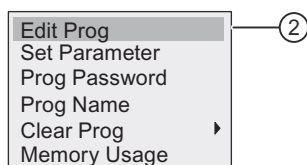

4. Select " ② ": Press ▲ or ▼.
5. Press **OK** twice to enter circuit program edit mode. A "U" identifies a UDF block. "U1" refers to the first UDF block. The following display shows you an example of the circuit program that contains a UDF block configured from WindLGC.

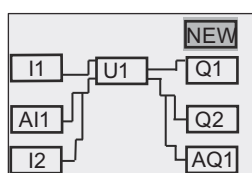



6. Move the cursor to "U1": Press ▲, ▼, ◀ or ▶.
7. Press **OK** to enter the screen form for the first UDF block "U1". To select another element, press the cursor keys.

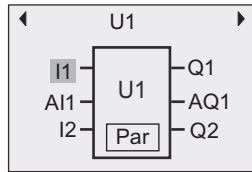

8. Position the cursor on the selected input ("I1" in this example) and press **OK**. The cursor appears in a flashing solid square. If you want to change the first input to another element, press ▲ or ▼.
9. Confirm your selection by pressing **OK**. The first input of "U1" is now changed.

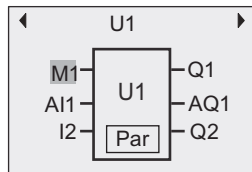

### Editing elements to the outputs of a UDF block

If IDEC SmartRelay shows the following screen form as shown in the above Step 5 and you want to change "Q1" to another element, follow the steps below:

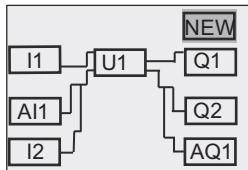

1. Press **OK** and IDEC SmartRelay shows the following display:

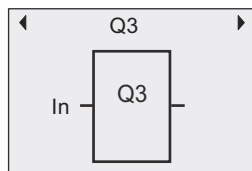

2. Move the cursor to "In" by pressing ◀. Press **OK** and the cursor appears in a flashing solid square. You can change the input to "U1.1" (".1" refers to the first output of the UDF block that is connected to "Q1") by pressing ▲ or ▼ and IDEC SmartRelay shows the following display:

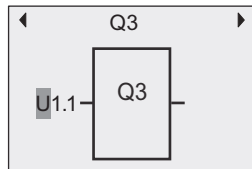

3. Confirm your selection by pressing **OK**. Press **ESC** and IDEC SmartRelay shows the following display:

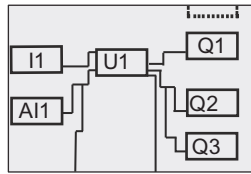

Now "U1" is connected to "Q3".

4. Press **OK** and move the cursor to "Q1" by pressing **▲**, **▼**, **◀** or **▶**. Press **OK** and IDEC SmartRelay shows the following display:

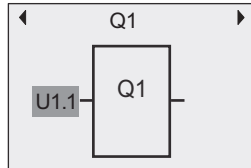

5. Press **OK** and the cursor appears in a flashing solid square. Select an empty input by pressing **▲** or **▼**. Press **OK** and IDEC SmartRelay shows the following display:

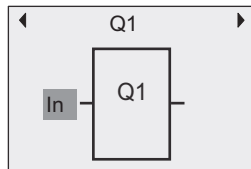

6. Press **ESC** and IDEC SmartRelay shows the following display:

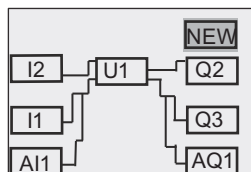

Now the connection between "U1" and "Q1" is removed.

You have changed the element connected to the first output of "U1" from "Q1" to "Q3".

### Setting the Par parameter

You can edit the **Par** parameter for your UDF block if you have configured parameters for this UDF using WindLGC; otherwise, you cannot edit parameters for UDF blocks. If your UDF block contains the **Par** parameter, you can edit the parameters as described below:

View in programming mode (example):

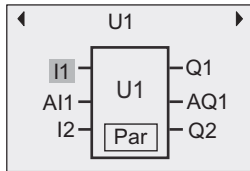

1. Press **▼** to move the cursor to "Par" and press **OK**. IDEC SmartRelay shows you the following display (T and TH are the identifiers you specified for the relevant UDF parameters in WindLGC. You can configure a maximum of eight parameters for each UDF block using WindLGC. IDEC SmartRelay can show a maximum of three parameters on a single display.):

First view of U1 parameters

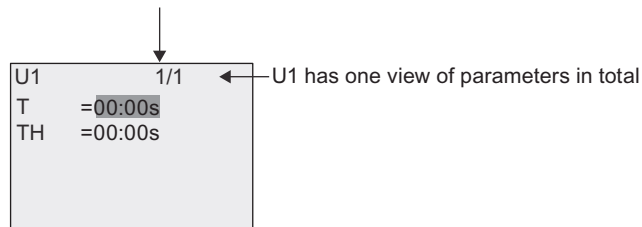

2. Press **OK** and the cursor moves to the first number of "T":



3. Press **▲** or **▼** to change the value. Press **◀** or **▶** to select another number and then press **▲** or **▼** to change its value. Press **OK** to confirm your modifications. Then IDEC SmartRelay shows the following display:

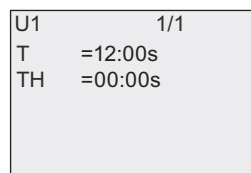

You can also edit UDF parameter settings in parameter assignment mode in the same way as you do in programming mode.

You can configure a maximum of one data log for your circuit program using WindLGC. The data log records process measurement variables for function blocks that you configure for data logging. You can add the data log instruction to your circuit program as you do with a function block.

If you configured the data log for your circuit program, after transferring the program from WindLGC to IDEC SmartRelay, you can edit the elements connected to the data log block.

For a detailed description of configuration of the data log function in WindLGC, refer to the Online Help for WindLGC. From the Base Module, you can only configure elements connected to the data log block.

## Editing elements connected to the data log block

If your circuit program in IDEC SmartRelay contains a data log block configured from WindLGC, you can edit elements connected to this data log as follows:

1. Switch to programming mode. Press **OK** twice to step into the following display of your circuit program:

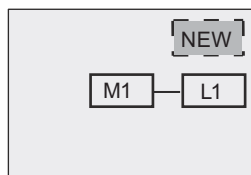

2. Move the cursor to "L1" by pressing **▼** (The data log is identified with a "L1"). Press **OK**. IDEC SmartRelay shows the following display:

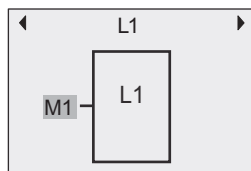

3. Press **OK** on the selected input ("M1" in this example) and the cursor appears in a flashing solid square. To select a different element from the available list (for example, B3), press **▼**. Press **OK**. IDEC SmartRelay shows the following display:

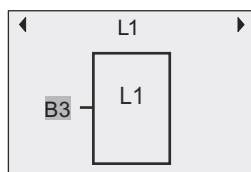

4. In the following example, you can see that this "L1" is now connected to the B3 block:

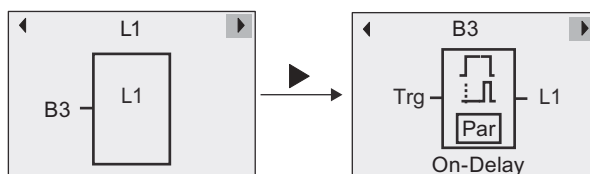

---

**Note**

IDEC SmartRelay provides a 1024-byte buffer for data logging. If the data in this buffer reaches 512 bytes, IDEC SmartRelay automatically writes data to the micro SD card inserted in the card slot. If the speed of data generation in IDEC SmartRelay is faster than that of data writing to the micro SD card, data loss can occur. To avoid the occurrence of data loss, apply an enable signal to the data log function block at a minimum time interval of 500 ms. If, however, no micro SD card is inserted in the card slot, the buffer area in IDEC SmartRelay can only store 512 bytes of data log and the left data log gets lost.

A micro SD card can store a maximum of 50 data log files for each Base Module. If you insert the same card into another Base Module, it can store another 50 data log files for the current Base Module, but the maximum number of lines that a card can store is limited to its memory size. A data log file on the micro SD card can store a maximum of 20000 lines. If the memory of the micro SD card is full and you want to create a new data file, then an error message will be generated automatically.

IDEC SmartRelay automatically creates file names with the format of "<XYZ>\_<number>.csv". <XYZ> stands for the last part of the four-part IP address code of the connected Base Module. It ranges from one digit to three digits. <number> indicates the sequential number of the created data file and ranges from 1 to 50. Do not change the file name because the Base Module cannot recognize user-defined names.

You can only upload the most recent data log file on the micro SD card from IDEC SmartRelay to WindLGC.

Under the following circumstances, IDEC SmartRelay creates a new data log file:

- When the circuit program in IDEC SmartRelay is changed
- When the number of lines in the data log file exceeds 20000

The created file will have a name with an increased number index, for example, if the name for the current data file is "135\_1.csv", the new file will be named "135\_2.csv".

---

Parameter assignment refers to the configuration of the block parameters. You can set delay times for time functions, the switching times of timers, counter threshold values, the monitoring interval of an operating hours counter, the on and off thresholds of the trigger, and more.

You can configure the parameters:

- In programming mode
- In parameter assignment mode

Parameter assignment mode allows the editing of parameters without having to modify the circuit program. This feature is available so that you can edit parameters without having to change to programming mode. The advantage is that you can edit program parameters, but the circuit program remains protected.

---

**Note**

In parameter assignment mode, IDEC SmartRelay continues execution of the circuit program.

## 8.1 Selecting parameter assignment mode

Press ESC to access the parameter assignment mode:

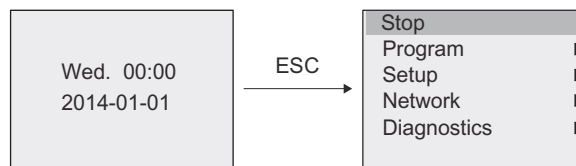

For more information about the menu commands in parameter assignment mode, refer to Section "Base Module (Page 317)".

Follow these steps to stop your circuit program and thus change to the main menu of programming mode:

1. Move the cursor to " ① ": Press ▲ or ▼.

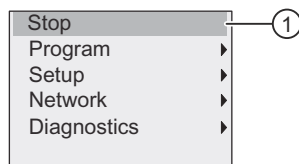

2. Confirm " ① ": Press OK.
3. Move the cursor to " ② ": Press ◀.

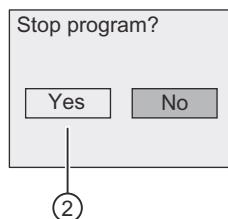

- 4. Confirm placing IDEC SmartRelay in STOP mode by pressing **OK** with the cursor on " ② ".

IDEC SmartRelay shows the main menu of the programming mode:

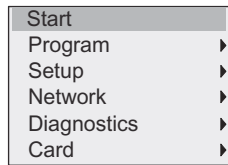

For more information about switching IDEC SmartRelay to RUN mode, refer to Section "Switching IDEC SmartRelay to RUN mode (Page 74)".

### Description of other menu commands of the parameter assignment menu

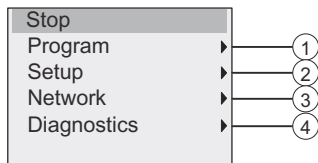

- **Menu command ①**

For information on the various settings, refer to the following topics:

- Parameters (Page 261)
- Selecting the parameters (Page 261)
- Modifying parameters (Page 262)
- Assigning a circuit program name (Page 69)

- **Menu command ②**

For information on the various settings, refer to the following topics:

- Setting the time of day and date (Page 265)
- Summertime/wintertime conversion (Page 90)
- Network Time Protocol (FL1F FS5 and later versions only) (Page 94)
- Setting the start screen (Page 271)
- Setting the display contrast and backlight choice (Page 267)
- Setting the default values for IDEC SmartRelay (Page 264)

- **Menu command ③**

For information on the various settings, refer to the topic "Configuring network settings (Page 97)".

- **Menu command ④**

For information on the various settings, refer to the topic "Diagnosing errors from IDEC SmartRelay (Page 102)".

## 8.1.1 Parameters

### Note

You can only view and edit parameters in the parameter assignment mode when they have the read/write ("+") designation. See the "Parameter protection (Page 127)" topic.

Parameters are, for example:

- The delay times of a timer relay
- The switching times (cams) of a timer switch
- Counter thresholds
- The monitoring time for hour counters
- The trigger thresholds

A block number (Bx) and the short name of the parameter identifies each parameter. Examples:

- T: ...is a configurable time
- MI: ...is a configurable time interval

### Note

WindLGC also allows you to assign names to blocks (for more information, refer to the chapter entitled "IDEC SmartRelay software (Page 287)".

## 8.1.2 Selecting the parameters

To select a parameter:

1. On the parameter assignment menu, move the cursor to " ① ": Press ▼ or ▲.

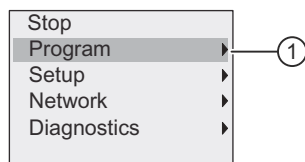

2. Confirm " ① " with **OK**.
3. Move the cursor to " ② ": Press ▼ or ▲.

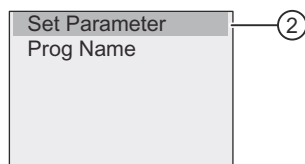

4. Confirm " ② " with **OK**.

IDEC SmartRelay shows the list of all available blocks, for example:

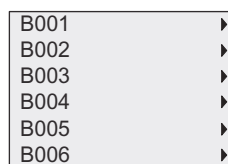



If no parameter can be set, the display shows as follows, and you can press **ESC** to return to the parameter assignment menu.

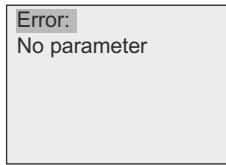

- Press **▲** or **▼** to move the cursor to the block that you desire to change its parameter, and confirm with **OK**.

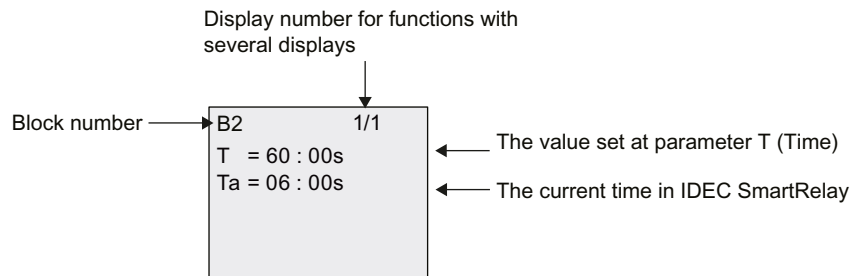

- Now, select the desired parameter: Press **▲** or **▼**.
- Select the parameter you want to edit, and press **OK**.

### 8.1.3 Modifying parameters

You first Selecting the parameters (Page 261).

You change the value of the parameter in the same way as you did in programming mode:

- Move the cursor to the point at which you want to make the change: Press **◀** or **▶**.
- To change this value: Press **▲** or **▼**.
- To apply the value: **OK**.

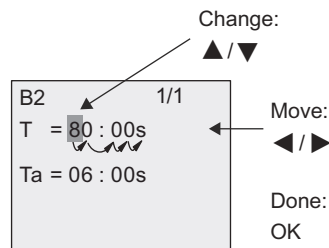

#### Note

When changing the time parameter when the system is in RUN, you can also change the timebase (s=seconds, m=minutes, h=hours). This does not apply if the time parameter represents the result of another function (for an example, see the "On-delay (Page 134)" topic). In this case you can neither change the value nor the timebase. The current time is reset to zero when you change the timebase.

### Current value of a time T

View of a time T in parameter assignment mode:

B2	1/1	
T	= 60 : 00s	← Configured time T
Ta	= 06 : 00s	← Current time Ta

You can change the configured time T.

### Current timer value

View of a timer cam in parameter assignment mode:

B9	1/2
D1	= M-W-F--
On1	= 09 : 00
Off1	= 10 : 00
D2	= -T-----
On2	= 03 : 00
▲ ▼	
B9	2/2
Off2	= 04:15
D3	= -----SS
On3	= 16:30
Off3	= 23:10
Pulse	= Off

You can change the on/off times and the day.

### Current value of a counter

View of a counter parameter in parameter assignment mode:

<table style="width: 100%; border-collapse: collapse;"> <tr> <td style="padding: 2px;">B3</td> <td style="padding: 2px;">1/1</td> </tr> <tr> <td style="padding: 2px;">On</td> <td style="padding: 2px;">=+1234</td> </tr> <tr> <td style="padding: 2px;">Off</td> <td style="padding: 2px;">=+0</td> </tr> <tr> <td style="padding: 2px;">Cnt</td> <td style="padding: 2px;">=+120</td> </tr> <tr> <td style="padding: 2px;">STV</td> <td style="padding: 2px;">=+100</td> </tr> </table>	B3	1/1	On	=+1234	Off	=+0	Cnt	=+120	STV	=+100	or	<table style="width: 100%; border-collapse: collapse;"> <tr> <td style="padding: 2px;">B3</td> <td style="padding: 2px;">1/1</td> </tr> <tr> <td style="padding: 2px;">On</td> <td style="padding: 2px;">=+123456</td> </tr> <tr> <td style="padding: 2px;">Off</td> <td style="padding: 2px;">=→B021</td> </tr> <tr> <td style="padding: 2px;">Cnt</td> <td style="padding: 2px;">=+120</td> </tr> <tr> <td style="padding: 2px;">STV</td> <td style="padding: 2px;">=+100</td> </tr> </table>	B3	1/1	On	=+123456	Off	=→B021	Cnt	=+120	STV	=+100
B3	1/1																					
On	=+1234																					
Off	=+0																					
Cnt	=+120																					
STV	=+100																					
B3	1/1																					
On	=+123456																					
Off	=→B021																					
Cnt	=+120																					
STV	=+100																					
←	Current count value	→																				

You can change the on/off threshold. This does not apply if the on or off threshold represents the result of another function (In the "Up/down counter (Page 169)" topic, this is B021).

### Current value of an hour counter

View of an hour counter parameter in parameter assignment mode:

B16	1/1	
MI	=100h:0m	← Time interval
OT	=83h:15m	← Total operating hours
MN	=16h:45m	← Time-to-go

You can edit the configured time interval MI.

### Current value of a frequency trigger

View of the parameter of a frequency trigger in parameter assignment mode:

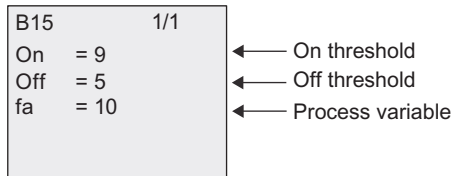

You can change the on/off threshold.

## 8.2 Setting the default values for IDEC SmartRelay

You can set the following default values for a Base Module:

### Clock settings

You can set the default values for time-of-day and date (Page 265), and Summertime/wintertime conversion (Page 90) and Network Time Protocol (FL1F FS5 and later versions only) (Page 94) in programming mode or parameter assignment mode through the following menu commands:



### Contrast and backlight settings

You can set the default value for the backlight (Page 267) and the default value for the display contrast (Page 267) in programming mode or parameter assignment mode through the following menu commands:

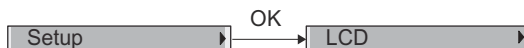

### Menu language

You can Setting the menu language (Page 269) in which IDEC SmartRelay displays the menus in programming mode through the following menu commands:

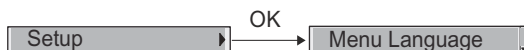

### Number of Base Module analog inputs

The Base Modules FL1F-H12SCD, FL1F-H12RCE, and FL1F-B12RCE support four analog inputs. Formerly they supported two. You can choose whether to Setting the number of AIs in IDEC SmartRelay (Page 270) on these modules in programming mode through the following menu commands:



## Start screen settings

You can select the Setting the start screen (Page 271) that displays on IDEC SmartRelay when IDEC SmartRelay transfers to RUN mode in programming mode or parameter assignment mode through the following menu commands:

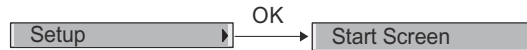

## Message text settings

You can select settings that apply to all Message text function blocks (Page 197) in programming mode or parameter assignment mode through the following menu commands:

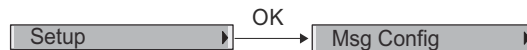

### 8.2.1 Setting the time of day and date

You can set the time of day and the date in programming mode or parameter assignment mode.

#### Setting the time of day and the date in parameter assignment mode

Follow these steps to set the time of day and the date:

1. Selecting parameter assignment mode (Page 259).
2. On the parameter assignment menu, move the cursor to " ① ": Press ▼ or ▲.

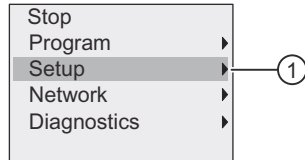

3. Confirm " ① ": Press **OK**.
4. Move the cursor to " ② ": Press ▲ or ▼.

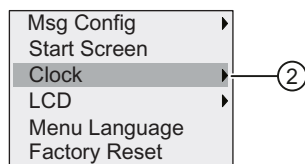

5. Confirm " ② ": Press **OK**.
6. Move the cursor to " ③ ": Press ▲ or ▼.

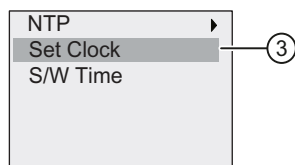

7. Confirm " ③ ": Press **OK**.

IDEC SmartRelay shows the following display.



- 8. To set the correct time of day, press ◀ or ▶ to move the cursor to the desired position, and press ▲ or ▼ to change the value.
- 9. To set the correct date, press ◀ or ▶ to move the cursor to the desired position, and press ▲ or ▼ to change the value.
- 10. To confirm your entries: Press **OK**.

### Setting the time of day and the date in programming mode

If you want to set the time of day and the date in programming mode, select " ① " in the main menu, then menus " ② " and " ③ ". You can now set the date and the time as described earlier.

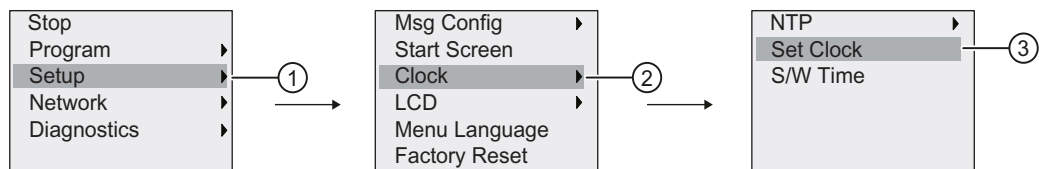

## 8.2.2 Setting the display contrast and backlight choice

You can set the default value for the display contrast and backlight in programming mode or parameter assignment mode.

### Setting the display contrast in parameter assignment mode

Follow these steps to set the display contrast:

1. Selecting parameter assignment mode (Page 259).
2. On the parameter assignment menu, move the cursor to " ① ": Press ▼ or ▲.

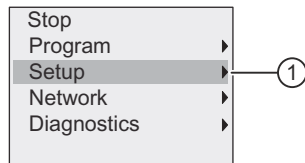

3. Confirm " ① ": Press **OK**.
4. Move the cursor to " ② ": Press ▼ or ▲.

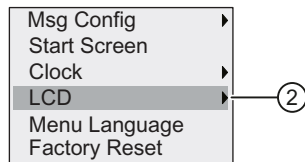

5. Confirm " ② ": Press **OK**.
6. Move the cursor to " ③ ": Press ▲ or ▼.



7. Confirm " ③ ": Press **OK**.

IDEC SmartRelay shows the following display:

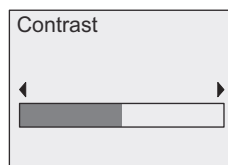

8. To change the display contrast: Press ◀ or ▶.
9. To confirm your entry: Press **OK**.

### Setting the display contrast in programming mode

If you want to set the display contrast in programming mode, select menu command " ① " in the main menu, then menus " ② " and " ③ ". You can now set the display contrast as described earlier.

### Setting the backlight choice in parameter assignment mode

Follow these steps to set the backlight choice:

1. On the parameter assignment menu, move the cursor to " ① ": Press ▼ or ▲.

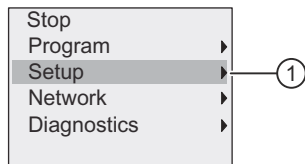

2. Confirm " ① ": Press **OK**.
3. Move the cursor to " ② ": Press ▼ or ▲.

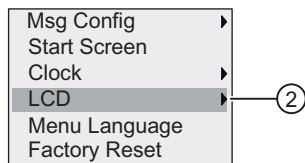

4. Confirm " ② ": Press **OK**.
5. Move the cursor to " ③ ": Press ▲ or ▼.

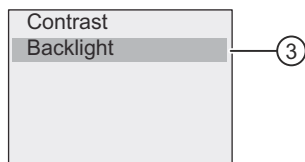

6. Confirm " ③ ": Press **OK**.
7. Move the cursor to " ④ " or " ⑤ ": Press ▼ or ▲.

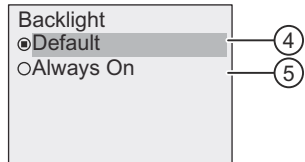

8. Confirm " ④ " or " ⑤ ": Press **OK**.

The default setting is that the backlight is not on. To set the backlight to always be on, select " ⑤ ".

### Setting the backlight choice in programming mode

If you want to set the backlight in programming mode, select menu command " ① " in the main menu, then menus " ② " and " ③ ". You can now set the backlight as described earlier.

---

#### Note

The backlight lifetime of the Text Display is 20000 hours.

You can change the backlight colors of the IDEC SmartRelay onboard display or the FL1F-RD1 by means of some special markers (M25, M26, M28 to M31). For more information, refer to section "Constants and connectors (Page 113)". If you use these special markers in your circuit programs, the backlight setting through the above menu commands takes no effect.

---

### 8.2.3 Setting the menu language

The language of the IDEC SmartRelay menus can be one of ten predefined languages:

German	English	French	Spanish	Italian
Chinese	Dutch	Turkish	Russian	Japanese

#### Setting the menu language in programming mode

You can set the menu language in programming mode only:

1. In the main menu of programming mode, move the cursor to " ① ": Press ▼ or ▲.

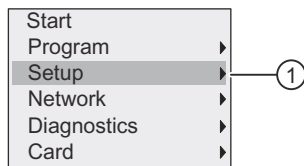

2. Confirm " ① ": Press **OK**.
3. Move the cursor to " ② ": Press ▼ or ▲.

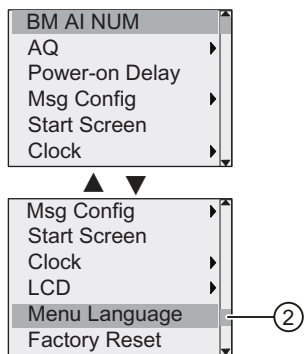

4. Confirm " ② ": Press **OK**.
5. Move the cursor to the language of your choice: Press ▲ or ▼.
6. Confirm language selection: Press **OK**.



### 8.2.4 Setting the number of AIs in IDEC SmartRelay

FL1F-H12RCE/B12RCE and FL1F-H12SCD support up to four onboard inputs that can be used as either digital or analog inputs (0 V to 10V). Inputs I7 (AI1) and I8 (AI2) are available as analog inputs by default, whether you use them or not. Inputs I1 (AI3) and I2 (AI4) are optional analog inputs. IDEC SmartRelay provides a menu where you can choose to use two analog inputs (the default, AI1 and AI2), or four, or even zero. Regardless of the settings, inputs I1 and I2 can be used as digital inputs. To use them as analog inputs AI3 and AI4, you must set the number of analog inputs to four. Note that the number of configured analog inputs on IDEC SmartRelay affects the subsequent numbering of analog inputs on attached expansion modules (see the "Maximum setup with expansion modules (Page 17)" topic).

You can set the number of AIs in programming mode only.

#### Setting the number of AIs in programming mode

Follow these steps to set the number of analog inputs:

1. In the main menu of programming mode, select " ① ": Press ▼ or ▲.

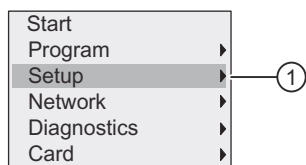

2. Confirm " ① ": Press OK.
3. Select " ② ": Press ▼ or ▲.

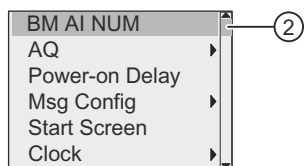

4. Confirm " ② ": Press OK.
5. Move to "0 AI", "2 AIs" or "4 AIs": Press ▲ or ▼.
6. Confirm your selection with OK, and the setting takes effect immediately.

## 8.2.5 Setting the start screen

You can select the default setting for the start screen that IDEC SmartRelay displays in RUN mode. You make this selection from IDEC SmartRelay in either parameter assignment mode or programming mode.

### Selecting the start screen in parameter assignment mode

Follow these steps to select the start screen for IDEC SmartRelay:

1. Selecting parameter assignment mode (Page 259).
2. On the parameter assignment menu, move the cursor to " ① ": Press ▼ or ▲.

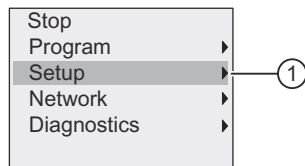

3. Confirm " ① ": Press **OK**.
4. Move the cursor to " ② ": Press ▲ or ▼.

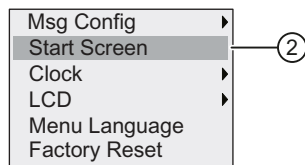

5. Confirm " ② ": Press **OK**.

The display now shows:

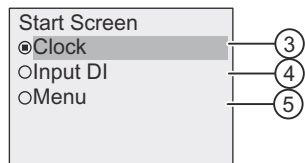

The current setting of the start screen is indicated by the circle with a dot. The default setting is " ③ ".

You can choose to display the current time-of-day and date ( ③ ), the values of the digital inputs ( ④ ), or the parameter assignment menu ( ⑤ ).

6. Select the desired default setting: Press ▲ or ▼.
7. To confirm your entry: Press **OK**.

Power IDEC SmartRelay off then on to make your changes take effect. When IDEC SmartRelay is in RUN mode, it displays the start screen that you selected.



## Using memory cards

IDEC SmartRelay supports only micro SD cards that support FAT32 file system format for program storage. You can store and copy-protect a circuit program, with or without the data log of process data, from an IDEC SmartRelay device to a micro SD card, or copy a circuit program from the card to an IDEC SmartRelay device.

IDEC SmartRelay allows you to store only one circuit program in its memory. If you want to modify the circuit program or create an additional one without deleting the first, you must archive it somewhere.

For detailed information about how to format micro SD cards, see Section "Formatting micro SD cards (Page 273)".

For detailed information about the copy protection function, see Section "Program copy protection (Page 284)".

For detailed information about the data log, see Chapter "Data log (Page 257)".

### 9.1 Formatting micro SD cards

As IDEC SmartRelay only supports micro SD cards that support FAT32 file system format for program storage, you must format the micro SD card first if it supports other file systems. The following examples describe how to format a micro SD card under Windows 7.

#### Formatting under Windows OS

Follow the steps below to format the micro SD card under Windows OS:

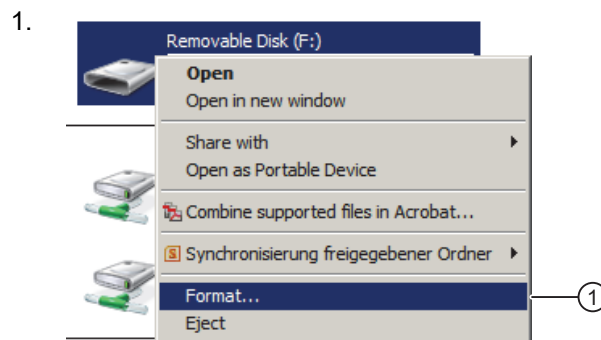

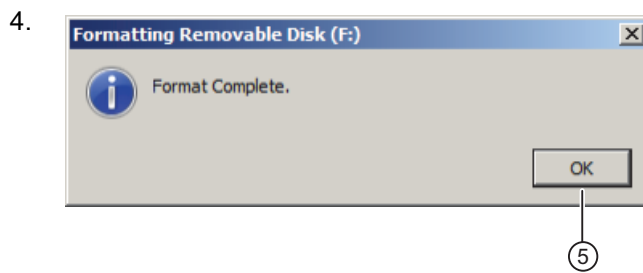
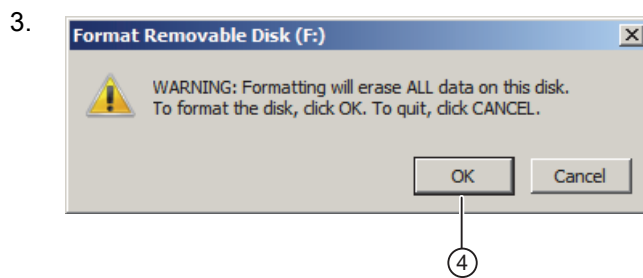
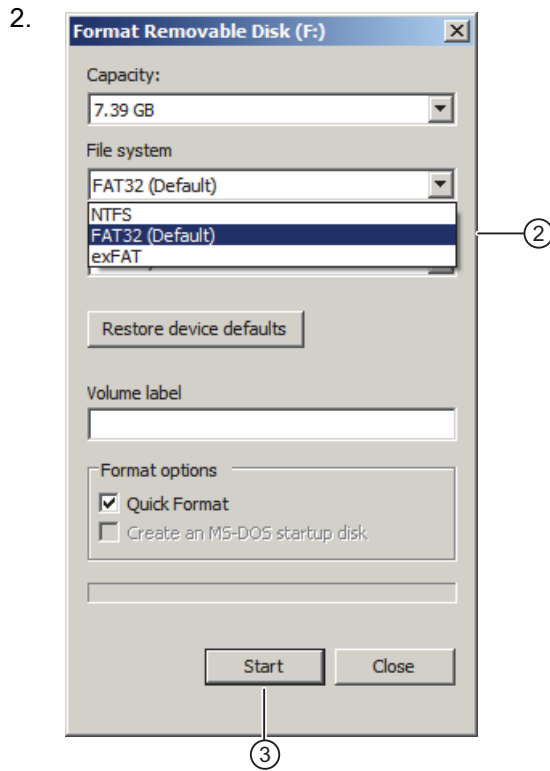

## 9.2 Inserting and removing the card from IDEC SmartRelay

Do not remove a micro SD card while SmartRelay accesses the micro SD card.

When you remove a micro SD card that contains a circuit program with copy protection attributes, note the following: IDEC SmartRelay can only execute the circuit program stored on the card if the card remains inserted during system runtime.

A removal of the card during RUN mode can lead to impermissible operating states.

### ⚠ WARNING

#### Fire hazard

Insert/remove under hazardous location may trigger a fire in the machine or plant.

Death or serious injury could occur.

Do not insert/remove the memory card in hazardous locations.

### Removing the micro SD card

To remove the micro SD card, carefully insert a screwdriver with a 3-mm blade into the groove on the front of the socket, and lever the socket partially out of the slot. Pull the socket to the position as the following figure shows. You can now remove the micro SD card from the card slot on the left side of the socket.

#### Note

To avoid any possible damage to the SD card socket, do not pull the socket completely out from the module.

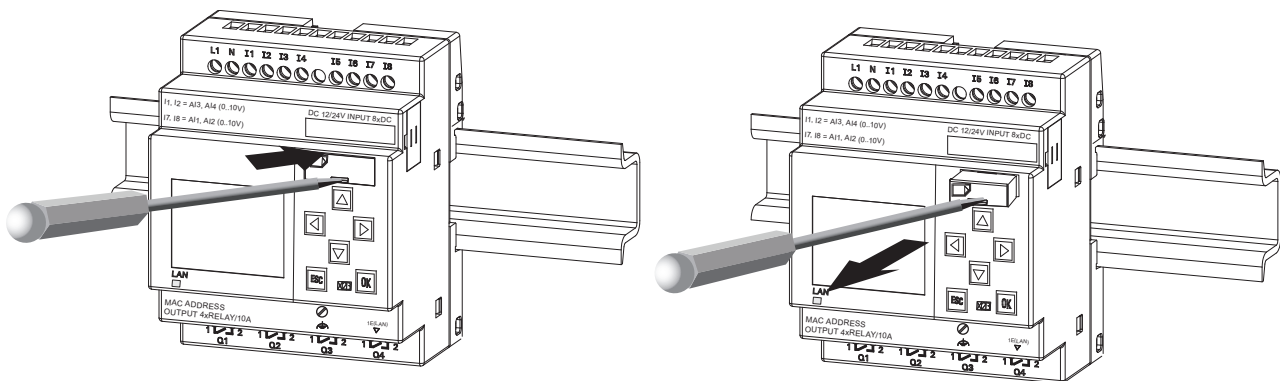

### Inserting the micro SD card

The entry of the card slot is chamfered on its bottom right. The edge of the cards is chamfered accordingly. This encoding prevents you from inserting cards in the wrong way. Insert the card into the holder and push it in until it engages.

**Note**

Make sure that you insert the card into the right position in the socket until you hear an audible sound of a click.

**Note**

If the SD card socket cannot be pushed in smoothly, don't push hard. Pull the card, adjust the direction, and push it in again. Refer to the following figure for the right direction.

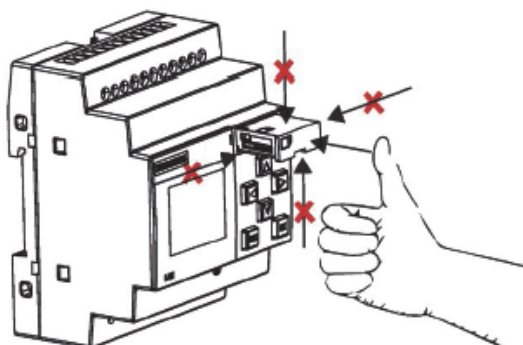

## 9.3 Copying data from IDEC SmartRelay to the card

### Copying data from IDEC SmartRelay to the card manually

To manually copy the circuit program to the micro SD card, follow the steps shown in the illustration below:

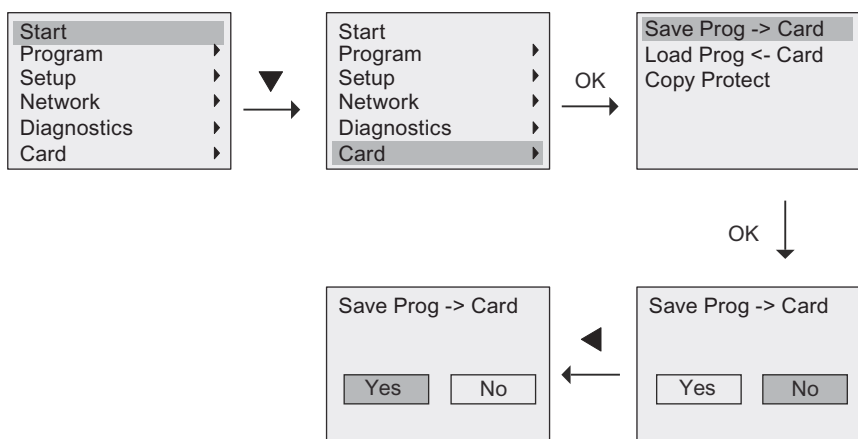

Press OK. IDEC SmartRelay starts copying the circuit program to the card.

If power fails while IDEC SmartRelay is copying the circuit program, repeat the process after power-on.

**Note**

- If the program is empty, a message will display on the screen to remind you the program in IDEC SmartRelay is empty.
- The password of a protected circuit program in IDEC SmartRelay also applies to the copied program version on your card.

### Copying data from IDEC SmartRelay to the card automatically

WindLGC provides an option for automatically copying the circuit program to the micro SD card when transferring the circuit program to IDEC SmartRelay. This option is available in the dialog for PC->IDEC SmartRelay transfer. If you select this option, WindLGC transfers the circuit program to IDEC SmartRelay and to the micro SD card.

---

**Note**

To successfully copy the circuit program from IDEC SmartRelay to the micro SD card, make sure that the free memory space available on the micro SD card is at least 100 Kbytes.

---

### Function block parameters can be saved automatically

In FL1F FS5, if the parameters for function block have some modifications, they can be saved to SD card automatically.

### Generating the data log on the micro SD card

If your circuit program in IDEC SmartRelay includes a Data Log function block configured from WindLGC, you can save the data log in your IDEC SmartRelay or on the micro SD card. If there is a micro SD card inserted into the slot of your IDEC SmartRelay, then when IDEC SmartRelay switches from STOP to RUN, it attempts to copy the data log to the micro SD card; otherwise, IDEC SmartRelay saves the data log in memory. At every STOP to RUN transition, IDEC SmartRelay determines the destination of the data log storage.

If IDEC SmartRelay copies the data log to the micro SD card, it saves the data log by default as .CSV file format, which you can then open from a PC. Each line in the .CSV file includes a time stamp, the function block number and the actual values recorded. For more information about the data log, refer to chapter "Data log (Page 257)".

---

**Note**

When IDEC SmartRelay with an inserted micro SD card is in STOP mode, you can upload the most recent data log file on the micro SD card to WindLGC using a transfer menu command in WindLGC. For more information about the data log uploading command, refer to the Online Help for WindLGC.

---



## 9.4 Copying data from the card to IDEC SmartRelay

You can copy a circuit program from a micro SD card to IDEC SmartRelay in one of the following ways:

- Automatically during the startup of IDEC SmartRelay (POWER ON)
- By means of the card specific menu of IDEC SmartRelay

---

### Note

If the program on the card is protected with a password, the copied program in IDEC SmartRelay is also protected with the same password. For more information about the Card menu, refer to Section "Overview of IDEC SmartRelay menus (Page 61)".

---

### Automatic copying during the startup of IDEC SmartRelay

To automatically copy the circuit program to IDEC SmartRelay, follow these steps:

1. Switch off the power supply to IDEC SmartRelay.
2. Insert the card into the relevant slot.
3. Switch on the power supply to IDEC SmartRelay.

IDEC SmartRelay copies the program from the memory cartridge to IDEC SmartRelay. When IDEC SmartRelay finishes copying, it opens the IDEC SmartRelay main menu:

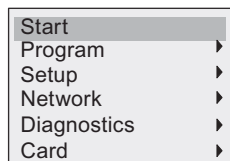

---

### Note

Before you switch IDEC SmartRelay to RUN, you must ensure that the system you are controlling with IDEC SmartRelay does not represent a source of hazard.

---

4. Move the cursor to the first menu command in Step 3: Press ▲ or ▼.
5. Press OK.

### Copying by means of the card specific menu

For more information about the replacement of a micro SD card, refer to Section "Inserting and removing the card from IDEC SmartRelay (Page 275)".

To copy a program from the card to IDEC SmartRelay, insert the card and follow the steps shown in the illustration below:

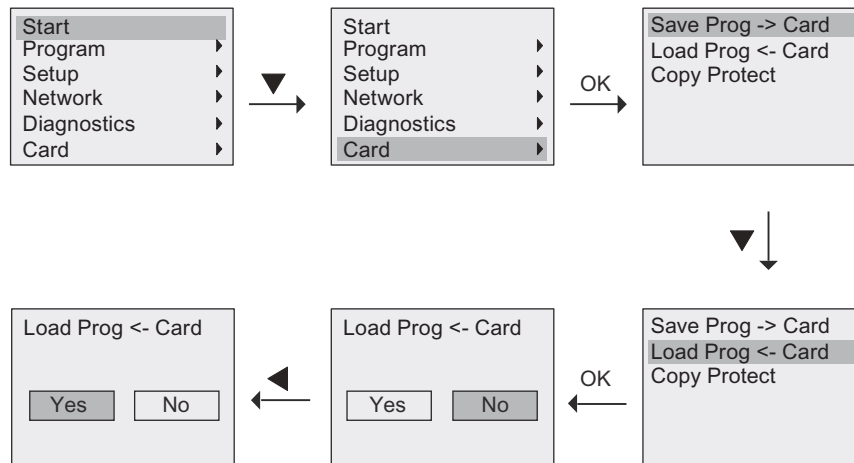

Press OK. IDEC SmartRelay copies the circuit program from the card to IDEC SmartRelay. When IDEC SmartRelay has finished copying, it automatically returns to the IDEC SmartRelay main menu.



## Overview

This chapter describes the following security functions for improved protection on IDEC SmartRelay:

Security function	Description
Network security	<p>The following ways can help you to protect your network communication:</p> <p>Define the Secure Network and Insecure Network zones for your network; If authentication, encryption, or integrity protection is required in the Secure Network zone, IDEC recommends that you protect network access to the IDEC SmartRelay devices with appropriate measures.</p> <p>If remote network connections to the IDEC SmartRelay devices are required, IDEC recommends protecting the communication to the IDEC SmartRelay with appropriate mechanism, for example by using VPN connections.</p> <p>For more information about Network security, you can refer to Network security (Page 281).</p>
Program access security	<p>The following protection methods can help you protect your circuit programs from unauthorized access:</p> <ul style="list-style-type: none"> <li>• Password protection</li> <li>• Copy protection</li> </ul> <p>For detailed information, you can refer to Program access security (Page 284).</p>
Menu access security	<p>You can limit access to specific menus of IDEC SmartRelay by setting the access level.</p> <p>For detailed information, you can refer to Menu access security (Page 286).</p>

### Note

The communication protocol for IDEC SmartRelay is designed for use in a trusted environment, and allows unauthenticated access to the devices. IDEC therefore strongly recommends protecting network access to the IDEC SmartRelay devices with appropriate mechanisms.

## 10.1 Network security

With the enhanced network security of IDEC SmartRelay FL1F devices, you can access the IDEC SmartRelay Base Modules not only through a local area network but through a remote area network. There are two steps that can help you to protect your network communication:

For your network, you can define Secure Network and Insecure Network zones. Place the following devices in the Secure Network zone:

- IDEC SmartRelay Base Modules
- FL1F-RD1
- FL1F Access Tool
- WindLGC
- NTP Client/NTP Server
- Modbus devices

The communication protocol for IDEC SmartRelay is designed for use in a trusted environment, and allows unauthenticated access to the devices. If authentication, encryption, or integrity protection is required in the Secure Network zone, IDEC recommends that you protect network access to the IDEC SmartRelay devices with appropriate measures.

If remote network connections to the IDEC SmartRelay devices are required, IDEC recommends that you protect the communication to the IDEC SmartRelay with appropriate mechanisms, such as VPN connections.

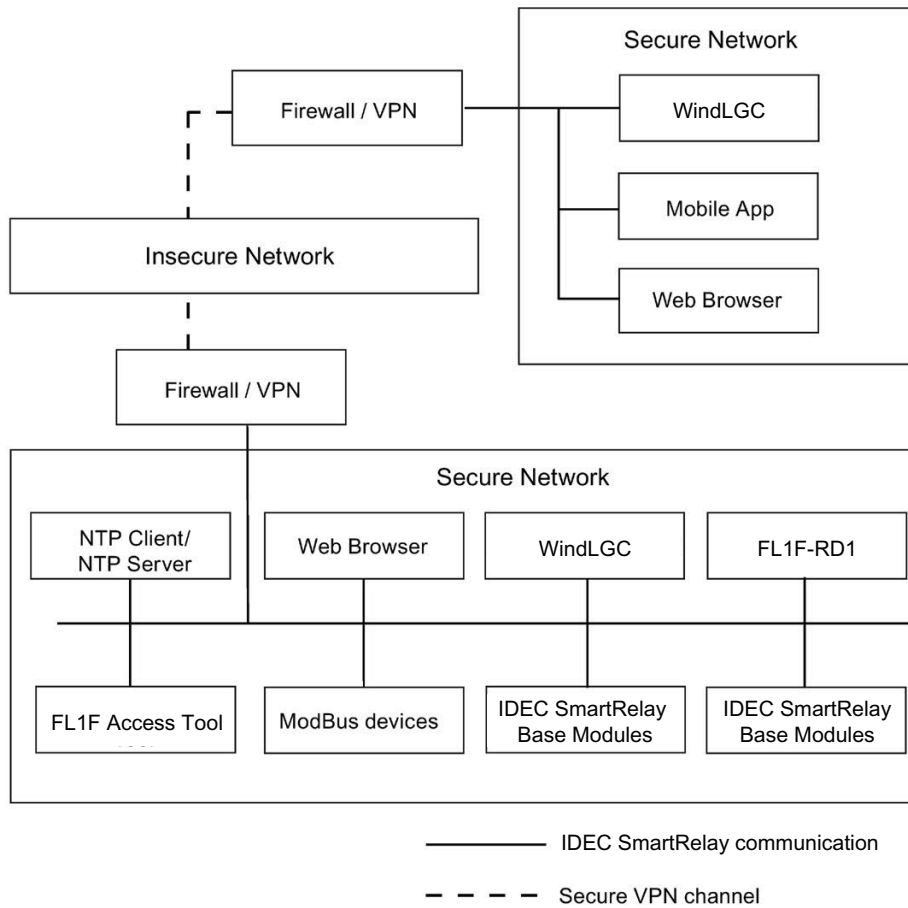

**Note**

To enhance the network security, IDEC strongly recommends you use VPN.

In order to maintain an adequate security level, IDEC strongly recommends that you open the ports only at firewalls within the Secure Network. The below table lists all the port information for the IDEC SmartRelay supported applications.

Supported APP	Port
FL1F Access Tool	80
WindLGC	8080, 10005
FL1F-RD1	135
Mobile APP	8080
Modbus Device	502-510
FL1F Communication	102
Web Browser	80,8080

 **WARNING**

**Death, severe personal injury and/or property damage from unauthorized access to IDEC SmartRelay from the Web server**

With WindLGC, you can enable remote access to IDEC SmartRelay from the Web server. You can then perform program/variable changes from the Web server.

Unauthorized access to IDEC SmartRelay from the Web server could disrupt process operation and could result in death, severe personal injury and/or property damage.

IDEC recommends that you observe the following security practices:

- Password-protect Web server access to IDEC SmartRelay with a strong password. Strong character; are at least eight characters in length; mix letters, numbers, and special characters; are not words that can be found in a dictionary; and are not names or identifiers that can be derived from personal information. Keep the password secret and change it frequently.
- Perform error-checking and range-checking on your variables in your program logic.

## 10.2 Program access security

### 10.2.1 Program password protection

You can protect your circuit program from unauthorized access with a password. IDEC strongly recommends you use password protection to prevent unauthorized reading or editing of your circuit programs.

For more information about assigning and changing a program password, refer to Section "Password for circuit program protection (Page 70)".

---

#### Note

If a password protection program is stored in a IDEC SmartRelay Base Module and you want to download a new one, you must enter the password in order to unlock the current program.

---

### 10.2.2 Program copy protection

The copy protection function provides protection for circuit programs on micro SD cards. A circuit program is **protected** when you transfer it to a protected memory card.

This additional security feature allows you to bind the circuit program to a specific memory card. If you copy a protected circuit program to another memory card, IDEC SmartRelay cannot recognize the program and rejects loading it after you insert the card.

To execute this circuit program in IDEC SmartRelay, you must leave the card in the IDEC SmartRelay Base Module; that is, you cannot remove the card to copy the program to other IDEC SmartRelay devices.

A circuit program with password protection is no longer protected after the correct password has been entered; that is, you can then edit or copy the program and remove the card.

#### Operation status under the different functions

The following table describes which operations are possible:

Operations	Editing	Copying	Deleting
Without Program password protection and without Program copy protection	Yes	Yes	Yes
With Program password protection, without Program copy protection	Yes, with password	Yes	Yes
Without Program password protection, with Program copy protection	No	No	Yes
With Program password protection and with Program copy protection	Yes, with password	Yes, with password	Yes

## Enabling the protection function

To assign the copy protection function to the card, follow these steps:

1. Enter the programming mode and move the cursor to " ① ": Press ▼ or ▲.

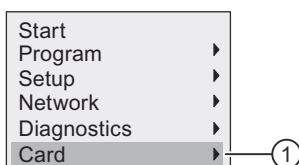

2. Confirm " ① " with **OK**.
3. Move the cursor to " ② ": Press ▼ or ▲.

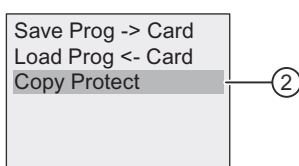

4. Confirm " ② " with **OK**.

IDEC SmartRelay shows the following display:

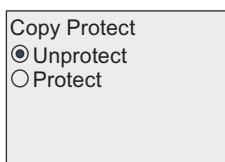

By default, the card is unprotected.

5. Move the cursor to " ③ ": Press ▼ or ▲.

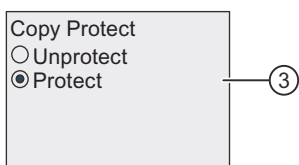

6. Confirm your selection by pressing **OK**.
7. Move the cursor to " ④ ": Press ▼ or ▲.

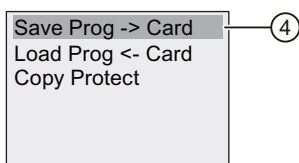

8. Confirm " ④ " with **OK**.
9. Move the cursor to " ⑤ ": Press ▼ or ▲.

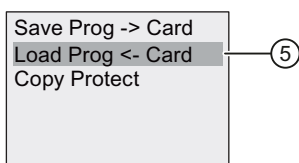

10. Confirm " ⑤ " with **OK**.

Then you can enable the protection function and save the program to card.



---

**Note**

The protection function applies only to the card; you must Copying data from IDEC SmartRelay to the card (Page 276) the circuit program to the card in a separate action at power-on.

You can always change the status of the protection function from "disabled" to "enabled".

You can always change the status of the card protection from "protection function disabled" to "protection function enabled".

---

## 10.3 Menu access security

IDEC SmartRelay provides two access levels, administrator and operator, to limit access to specific menus in programming mode. As an administrator, you can access all menu commands. As an operator, some specific menu commands are not visible. IDEC SmartRelays default setting is administrator, which you can change to operator at any time. When switching from operator to administrator, you must enter a valid password ("IDEC" by default).

---

**Note**

For menu access security, IDEC recommend that you change the default password to a strong password. Strong passwords are at least eight characters in length; mix letters, numbers, and special character; are not words that can be found in a dictionary; and are not names or identifiers that can be derived from personal information. Keep the password secret and change it frequently.

---

IDEC SmartRelay always saves its access level before power-off. For more information about switching between the access levels, refer to section "Configuring menu access protection for IDEC SmartRelay (Page 59)".

---

**Note**

The access level of the FL1F-RD1 is operator by default, and you can switch it to administrator with the password.

The FL1F-RD1 saves its access level before power-off if it connects to the same IDEC SmartRelay Base Module after power-on. If you connect a different IDEC SmartRelay Base module to it, however, the FL1F-RD1 restores its access level to operator after power-on.

---

## 11.1 IDEC SmartRelay software

WindLGC is available as a programming package for the PC. This software provides many features, for example:

- A graphical user interface for offline creation of your circuit program by means of Ladder Diagram (contact chart / circuit diagram) or Function Block Diagram (function chart)
- Simulation of your circuit program on the PC
- Generating and printing of an overview chart for the circuit program
- Saving a backup of the circuit program on the hard drive or other media
- Comparing circuit programs
- Easy configuration of blocks
- Transferring the circuit program in both directions:
  - from IDEC SmartRelay to the PC
  - from the PC to IDEC SmartRelay
- Reading the values of the hour counter
- Setting the time of day
- Summertime/wintertime conversion
- Online testing that provides a display of status changes and process variables of IDEC SmartRelay in RUN mode:
  - Status of digital I/O, markers, shift register bits and cursor keys
  - Values of all analog I/O and markers
  - Results of all blocks
  - Current values (including the times) of selected blocks
- Starting and stopping circuit program execution from the PC (switching between RUN and STOP modes)
- Network communication
- Creating UDF (User-Defined Function) (Page 253) for use in a circuit program
- Configuring the Data log (Page 257) function block for your circuit program to record process values of the configured function blocks

The current version is WindLGC V8.2. The Online Help for WindLGC describes all of the programming functionality and design features.

### The IEEC SmartRelay advantages

As you can see, WindLGC offers many advantages:

- You can develop the circuit program on your PC.
- You simulate the circuit program on your computer and verify its functions before you actually implement it in your system.
- You can add comments to the circuit program and create hard copies.
- You can save a copy of your circuit program to the file system on your PC, to make it directly available for modifications.
- It takes only a few key actions to download the circuit program to IEEC SmartRelay.

### Supported operating systems

You can execute WindLGC on any of the following operating systems:

- 32 bit/64 bit Windows 7, Windows 8, Windows XP or Windows 10
- Java Runtime Environment 1.8.0\_121, which is recommended version.

### WindLGC V8.2

This is the current version of WindLGC. You will find all the functions and the functionality of the devices described in this manual in the version 8.2.

---

#### Note

Please note that the SmartRelay ladder programming is slightly different from PLC programming. In the case of a PLC, the output result on each line is reflected on the inputs within the same scan time. However, in the case of the IEEC SmartRelay, all the inputs are processed first and then the outputs. Thus the output results are not reflected on the inputs within the same scan time, but rather they are reflected at the following scan.

ex) Interlock is not activated in the sample program (1) below in which input terminals I1 and I2 are simultaneously turned on. The interlock is activated in the sample program (2) below in which input terminals I1 and I2 are simultaneously turned on.

(1)

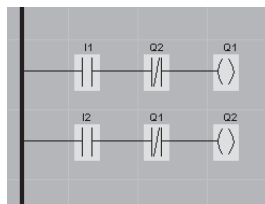

(2)

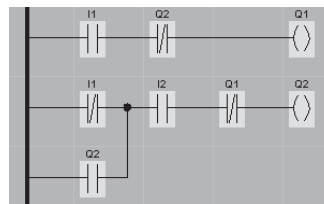

## Upgrading previous WindLGC versions

You can upgrade the WindLGC version from V2, V3, V4, V5, V6, or V8.0 to V8.2. And you can download the upgrade packages manually from ([www.idec.com](http://www.idec.com)).

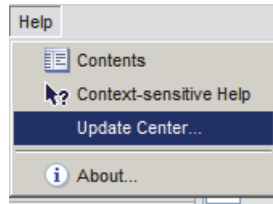

You can find type numbers in Section "Type numbers (Page 329)".

To upgrade from an old version to a new version, follow these steps:

1. Install the new software from the DVD.
2. When the system prompts you for the previous version, place the old WindLGC DVD in the DVD drive.
3. Point your browser to the "...\Application" directory on the DVD.

## Updates and information

You can download demo versions of the software free of charge from the Internet address specified in the Preface (Page ii).

For detailed information on updates, upgrades and the WindLGC Update Center, refer to the Online Help for WindLGC.

## 11.2 Connecting IDEC SmartRelay to a PC

### Connecting IDEC SmartRelay to a PC

IDEC SmartRelay has an Ethernet port so you can connect a Base Module to a PC with an Ethernet cable.

### Switching IDEC SmartRelay to PC ↔ IDEC SmartRelay mode

Two methods are available to switch IDEC SmartRelay to STOP mode:

- Switch IDEC SmartRelay to STOP mode from your PC (refer to the Online Help for WindLGC).
- Select the following menu command on a device with display.

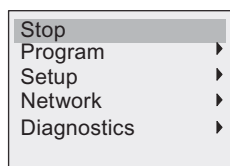

Confirm your selection with " ① ":

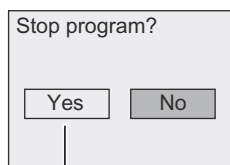

When IDEC SmartRelay is in STOP mode and online with the PC, the following PC commands are available:

- Switch IDEC SmartRelay to RUN
- Read/write the circuit program
- Read/write the summertime/wintertime

---

#### Note

For more information on IDEC SmartRelay versions without display, refer to the Appendix topic "IDEC SmartRelay without display ("IDEC SmartRelay Pure") (Page 315)".

---

### Closing the PC ↔ IDEC SmartRelay mode

When IDEC SmartRelay completes the data transfer, it shuts down the connection to the PC.

---

#### Note

If you have password-protected the program that you created in WindLGC, IDEC SmartRelay receives both the circuit program and the password during the download.

The upload of a password-protected program created in IDEC SmartRelay is possible only after you enter the correct password in WindLGC.

---

---

**Note**

IDEC SmartRelay sample applications are available to all our customers free of charge on the WindLGC DVD.

IDEC does not guarantee that the provided examples are error-free; they serve as general information about the fields of application for IDEC SmartRelay, and can be different from user-specific solutions. IDEC reserves the right to make changes.

You are responsible for the operation of your system.. For safety concerns, refer to the relevant national standards and system-related installation regulations.

---

On the WindLGC DVD you can find the following sample applications, tips for further applications, and more:

- Irrigation system for greenhouse plants
- Shop window lighting
- Bell system (for example, in a school)
- Parking lot surveillance
- Outdoor lighting
- Shutter control system
- Domestic outdoor and indoor lighting system
- Control system of a cream stirrer
- Sports hall lighting
- Constant load on three consumers
- Sequential control for boilers
- Cutting device (for example, for detonating fuses)
- Monitoring periods of utilization, for example of a solar energy system
- Intelligent foot switches, for example, for speed preselection)
- Elevating platform controls
- Impregnation of textiles, heating and conveyor belt controls
- Silo-filling system
- Fill station with message text on the Text Display that displays the sum of counted objects

On the WindLGC DVD you can also find descriptions and the corresponding circuit diagrams of the applications. You can read these \*.pdf files with the Adobe Acrobat Reader. If you have installed WindLGC on your computer, you can simply click the disk icon to download the relevant circuit programs, which you can then adapt to suit your application and download to IDEC SmartRelay directly via the PC cable.

## Benefits of IDEC SmartRelay

IDEC SmartRelay is a particularly useful feature:

- For replacing auxiliary switchgear with the integrated IDEC SmartRelay functions
- For saving wiring and installation work - because IDEC SmartRelay keeps the wiring "in its head."
- For reducing space requirements for components in the control cabinet/distribution box. A smaller control cabinet/distribution box may provide sufficient space.
- For adding or changing functions, without having to install additional switchgear or change the wiring.
- For offering your customers new, additional functions for domestic and commercial housing installations. Examples:
  - Domestic security systems: IDEC SmartRelay switches on a lamp at regular intervals or opens and closes the shutters while you are on holiday.
  - Central heating: IDEC SmartRelay runs the circulation pump only when water or heating is actually required.
  - Refrigerating systems: IDEC SmartRelay can defrost refrigerating systems at regular intervals to save energy costs.
  - You can illuminate aquaria and terraria on a time-dependent basis.

Last but not least, you can:

- Use commonly available switches and pushbuttons, which makes it easy to install a domestic system.
- Connect IDEC SmartRelay directly to your domestic installation; the integrated power supply makes it possible.

# Technical data



## A.1 General technical data

Criterion	Tested in accordance with	Values
<b>Base Modules (FL1F)</b> <b>(Version with display)</b> Dimensions (WxHxD) Weight <ul style="list-style-type: none"> <li>• Modules with relay output</li> <li>• Modules with transistor output</li> </ul> Installation		71.5 x 90 x 60 mm  Approx. 240 g Approx. 195 g On a 35 mm profile rail four module widths or wall mounting
<b>(Version without display)</b> Dimensions (WxHxD) Weight <ul style="list-style-type: none"> <li>• Modules with relay output</li> <li>• Modules with transistor output</li> </ul> Installation		71.5 x 90 x 58 mm  Approx. 200 g Approx. 160 g On a 35 mm profile rail four module widths or wall mounting
<b>IDEC SmartRelay expansion modules FL1F-M08...</b> Dimensions (WxHxD) Weight <ul style="list-style-type: none"> <li>• Modules with relay output</li> <li>• Modules with transistor output</li> </ul> Installation		35.5 x 90 x 58 mm  Approx. 130 g Approx. 95 g On a 35 mm profile rail two module widths or wall mounting
<b>IDEC SmartRelay expansion modules FL1F-J2B2/K2BM2</b> Dimensions (WxHxD) Weight Installation		35.5 x 90 x 58 mm Approx. 95 g On a 35 mm profile rail two module widths or wall mounting
<b>FL1F-RD1 (Text Display with Ethernet interfaces)</b> Dimensions (WxHxD) Weight Installation		128.2 x 86 x 38.7 mm Approx. 220 g Bracket mounting
<b>Climatic conditions</b>		
Ambient temperature <ul style="list-style-type: none"> <li>• Horizontal installation</li> <li>• Vertical installation</li> </ul>	Low temperature to IEC 60068-2-1 High temperature to IEC 60068-2-2	-20 °C to +55 °C <sup>1)</sup> -20 °C to +55 °C
Storage and Transport		- 40 °C to +70 °C
Relative humidity	IEC 60068-2-30	From 10% to 95% no condensation
Air pressure		795 hPa to 1080 hPa
Pollutants	IEC 60068-2-42 IEC 60068-2-43	SO <sub>2</sub> 10 cm <sup>3</sup> /m <sup>3</sup> , 21 days H <sub>2</sub> S 1 cm <sup>3</sup> /m <sup>3</sup> , 21 days



Criterion	Tested in accordance with	Values
<b>Ambient mechanical conditions</b>		
Degree of protection		IP20 for IDEC SmartRelay Base Modules, expansion modules, and the FL1F-RD1 excluding the TDE front panel IP65 for FL1F-RD1 front panel
Vibrations:	IEC 60068-2-6	5 Hz to 8.4 Hz (constant amplitude 3.5 mm) 8.4 Hz to 150 Hz (constant acceleration 1 g)
Shock	IEC 60068-2-27	half-sine wave 15 g/11 ms
Free fall (packaged)	IEC 60068-2-32	0.3 m
<b>EMC specification</b>		
Radiated emission	EN 55011 EN 55022	Limit class B group 1 Limit class B
Electrostatic discharge	IEC 61000-4-2	8 kV air discharge 6 kV contact discharge
Radiated electromagnetic field	IEC 61000-4-3	80 MHz-1000 MHz and 1.4 GHz-2.0 GHz 10V/m, 80% AM(1 kHz) 2.0 GHz-2.7 GHz 1V/m, 80% AM(1 kHz)
Conducted disturbance	IEC 61000-4-6	150 KHz-80 MHz 10 V, 80%AM(1 kHz)
Fast transient bursts	IEC 61000-4-4	<ul style="list-style-type: none"> <li>• For power port: 2 kV</li> <li>• For signal port:                             <ul style="list-style-type: none"> <li>- Signal Lines&lt;30 m: 1 kV/5 kHz</li> <li>- Signal Lines&gt;30 m: 2 kV/5 kHz</li> </ul> </li> </ul>
Surge immunity (applies only to FL1F-B12RCC/H12RCC)	IEC 61000-4-5	1 kV line-to-line 2 kV line-to-earth
<b>Safety to IEC</b>		
Clearance and creepage distance rating	IEC 60664, IEC 61131-2, UL 508 CSA C22.2 No. 142	Fulfilled
Insulation strength	IEC 61131-2	Fulfilled
<b>Cycle time</b>		
Cycle time per function		< 0.1 ms
<b>Startup</b>		
Startup time at power-up		Typ. 1.2 s
<b>FL1F communication</b>		
Delay time		Max. 100 ms
<b>Modbus communication</b>		
Delay time		Max. 100 ms

1) The updating rate of LCD can be reduced at operating temperature less than 0°C or above +55°C.

**Note**

The maximum length for directly connecting two IDEC SmartRelay Base Modules through CAT5e shielded network cable is 100 meters.

## A.2 Technical data: FL1F-B12RCC/H12RCC

	FL1F-B12RCC	FL1F-H12RCC
<b>Power supply</b>		
Input voltage	100 VAC/VDC to 240 VAC/VDC	100 VAC/VDC to 240 VAC/VDC
Permissible range	85 VAC to 265 VAC 100 VDC to 253 VDC	85 VAC to 265 VAC 100 VDC to 253 VDC
Permissible mains frequency	47 Hz to 63 Hz	47 Hz to 63 Hz
Power consumption	<ul style="list-style-type: none"> <li>• 115 VAC</li> <li>• 240 VAC</li> <li>• 115 VDC</li> <li>• 240 VDC</li> </ul>	<ul style="list-style-type: none"> <li>• 20 mA to 40 mA</li> <li>• 15 mA to 25 mA</li> <li>• 10 mA to 20 mA</li> <li>• 5 mA to 15 mA</li> </ul>
Voltage failure buffering	<ul style="list-style-type: none"> <li>• Typ. 10 ms</li> <li>• Typ. 20 ms</li> </ul>	<ul style="list-style-type: none"> <li>• Typ. 10 ms</li> <li>• Typ. 20 ms</li> </ul>
Power loss at	<ul style="list-style-type: none"> <li>• 115 VAC</li> <li>• 240 VAC</li> <li>• 115 VDC</li> <li>• 240 VDC</li> </ul>	<ul style="list-style-type: none"> <li>• 2.3 W to 4.6 W</li> <li>• 3.6 W to 6.0 W</li> <li>• 1.2 W to 2.3 W</li> <li>• 1.2 W to 3.6 W</li> </ul>
Backup of the real-time clock at 25 °C	Typ. 20 days	Typ. 20 days
Accuracy of the real-time clock	Typ. ± 2 s/day	Typ. ± 2 s/day
<b>Digital inputs</b>		
Number	8	8
Electrical isolation	No	No
Number of high speed inputs	0	0
Input frequency	<ul style="list-style-type: none"> <li>• Normal input</li> <li>• High speed input</li> </ul>	<ul style="list-style-type: none"> <li>• Max. 4 Hz</li> <li>• --</li> </ul>
Max. continuous permissible voltage	265 VAC 253 VDC	265 VAC 253 VDC
Input voltage L1	<ul style="list-style-type: none"> <li>• Signal 0</li> <li>• Signal 1</li> <li>• Signal 0</li> <li>• Signal 1</li> </ul>	<ul style="list-style-type: none"> <li>• &lt; 40 VAC</li> <li>• &gt; 79 VAC</li> <li>• &lt; 30 VDC</li> <li>• &gt; 79 VDC</li> </ul>
Input current at	<ul style="list-style-type: none"> <li>• Signal 0</li> <li>• Signal 1</li> <li>• Signal 0</li> <li>• Signal 1</li> </ul>	<ul style="list-style-type: none"> <li>• &lt; 0.05 mA AC</li> <li>• &gt; 0.08 mA AC</li> <li>• &lt; 0.06 mA DC</li> <li>• &gt; 0.13 mA DC</li> </ul>

	FL1F-B12RCC	FL1F-H12RCC
Delay time at 0 to 1:		
<ul style="list-style-type: none"> <li>• 120 VAC</li> <li>• 240 VAC</li> <li>• 120 VDC</li> <li>• 240 VDC</li> </ul>	<ul style="list-style-type: none"> <li>• Typ. 40 ms</li> <li>• Typ. 30 ms</li> <li>• Typ. 25 ms</li> <li>• Typ. 20 ms</li> </ul>	<ul style="list-style-type: none"> <li>• Typ. 40 ms</li> <li>• Typ. 30 ms</li> <li>• Typ. 25 ms</li> <li>• Typ. 20 ms</li> </ul>
Delay time at 1 to 0:		
<ul style="list-style-type: none"> <li>• 120 VAC</li> <li>• 240 VAC</li> <li>• 120 VDC</li> <li>• 240 VDC</li> </ul>	<ul style="list-style-type: none"> <li>• Typ. 45 ms</li> <li>• Typ. 70 ms</li> <li>• Typ. 60 ms</li> <li>• Typ. 75 ms</li> </ul>	<ul style="list-style-type: none"> <li>• Typ. 45 ms</li> <li>• Typ. 70 ms</li> <li>• Typ. 60 ms</li> <li>• Typ. 75 ms</li> </ul>
Line length (unshielded)	max. 100 m	max. 100 m
<b>Digital outputs</b>		
Number	4	4
Output type	Relay outputs	Relay outputs
Electrical isolation	Yes	Yes
Dielectric Strength (between power/input terminals and output terminals)	2,500 V AC, 1minute 500 V DC, 1 minute	2,500 V AC, 1minute 500 V DC, 1 minute
In groups of	1	1
Control of a digital input	Yes	Yes
Continuous current $I_{th}$	Recommended range of application $\geq 100$ mA at 12 VAC/VDC Max. 10 A per relay	Recommended range of application $\geq 100$ mA at 12 VAC/VDC Max. 10 A per relay
Relay rated voltage	240 VAC/VDC	240 VAC/VDC
Surge current	Max. 30 A	Max. 30 A
Incandescent lamp load (25000 switching cycles) at		
<ul style="list-style-type: none"> <li>• 230/240 VAC</li> <li>• 110/120 VAC</li> </ul>	<ul style="list-style-type: none"> <li>• 1000 W</li> <li>• 500 W</li> </ul>	<ul style="list-style-type: none"> <li>• 1000 W</li> <li>• 500 W</li> </ul>
Fluorescent tubes with ballast (25000 switching cycles)	10 x 58 W (at 230/240 VAC)	10 x 58 W (at 230/240 VAC)
Fluorescent tubes, conventionally compensated (25000 switching cycles)	1 x 58 W (at 230/240 VAC)	1 x 58 W (at 230/240 VAC)
Fluorescent tubes, uncompensated (25000 switching cycles)	10 x 58 W (at 230/240 VAC)	10 x 58 W (at 230/240 VAC)
Short circuit-proof cos 1	Power protection B16, 600 A	Power protection B16, 600 A
Short circuit-proof cos 0.5 to 0.7	Power protection B16, 900 A	Power protection B16, 900 A
Derating	None; across the entire temperature range	None; across the entire temperature range
Parallel output circuits for power increase	Not permitted	Not permitted
Protection of output relay (if desired)	Max. 16 A, characteristic B16	Max. 16 A, characteristic B16
Initial Contact Resistance	100 m $\Omega$ maximum (at 1A, 24V DC)	100 m $\Omega$ maximum (at 1A, 24V DC)

	FL1F-B12RCC	FL1F-H12RCC
Mechanical Life	10,000,000 operations minimum (no load, 10 Hz)	10,000,000 operations minimum (no load, 10 Hz)
Electrical Life	100,000 operations minimum (rated resistive load, 1800 operations / hour)	100,000 operations minimum (rated resistive load, 1800 operations / hour)
<b>Switching rate</b>		
Mechanical	10 Hz	10 Hz
Ohmic load/lamp load	2 Hz	2 Hz
Inductive load	0.5 Hz	0.5 Hz

Notice: For volume load such as fluorescent lamps with capacitors, you must consider the technical data of fluorescent lamp ballasts. If the current exceeds the maximum allowed surge current, appropriate contactor relays must switch the fluorescent lamps.

When you connect inductive load such as magnet or valve, it is recommended that you use diode for DC power supply and surge absorber for AC power supply to suppress the counter electromotive force.

### A.3 Technical data: FL1F-M08C2R2

	FL1F-M08C2R2
<b>Power supply</b>	
Input voltage	100 VAC/VDC to 240 VAC/VDC
Permissible range	85 VAC to 265 VAC 100 VDC to 253 VDC
Permissible mains frequency	47Hz to 63 Hz
Power consumption	<ul style="list-style-type: none"> <li>• 115 VAC</li> <li>• 240 VAC</li> <li>• 115 VDC</li> <li>• 240 VDC</li> </ul>
	<ul style="list-style-type: none"> <li>• 20 mA to 40 mA</li> <li>• 15 mA to 30 mA</li> <li>• 10 mA to 25 mA</li> <li>• 5 mA to 15 mA</li> </ul>
Voltage failure buffering	
<ul style="list-style-type: none"> <li>• 100 VAC/VDC</li> <li>• 240 VAC/VDC</li> </ul>	<ul style="list-style-type: none"> <li>• Typ. 10 ms</li> <li>• Typ. 20 ms</li> </ul>
Power loss at	
<ul style="list-style-type: none"> <li>• 115 VAC</li> <li>• 240 VAC</li> <li>• 115 VDC</li> <li>• 240 VDC</li> </ul>	<ul style="list-style-type: none"> <li>• 2.3 W to 4.6 W</li> <li>• 3.6 W to 7.2 W</li> <li>• 1.2 W to 2.9 W</li> <li>• 1.2 W to 3.6 W</li> </ul>
<b>Digital inputs</b>	
Number	4
Electrical isolation	No
Number of high speed inputs	0
Input frequency	
<ul style="list-style-type: none"> <li>• Normal input</li> <li>• High speed input</li> </ul>	<ul style="list-style-type: none"> <li>• Max. 4 Hz</li> <li>• - -</li> </ul>
Max. continuous permissible voltage	265 VAC 253 VDC

	FL1F-M08C2R2
Input voltage L1 <ul style="list-style-type: none"> <li>• Signal 0</li> <li>• Signal 1</li> <li>• Signal 0</li> <li>• Signal 1</li> </ul>	<ul style="list-style-type: none"> <li>• &lt; 40 VAC</li> <li>• &gt; 79 VAC</li> <li>• &lt; 30 VDC</li> <li>• &gt; 79 VDC</li> </ul>
Input current at <ul style="list-style-type: none"> <li>• Signal 0</li> <li>• Signal 1</li> <li>• Signal 0</li> <li>• Signal 1</li> </ul>	<ul style="list-style-type: none"> <li>• &lt; 0.05 mA AC</li> <li>• &gt; 0.08 mA AC</li> <li>• &lt; 0.06 mA DC</li> <li>• &gt; 0.13 mA DC</li> </ul>
Delay time at 0 to 1: <ul style="list-style-type: none"> <li>• 120 VAC</li> <li>• 240 VAC</li> <li>• 120 VDC</li> <li>• 240 VDC</li> </ul> Delay time at 1 to 0: <ul style="list-style-type: none"> <li>• 120 VAC</li> <li>• 240 VAC</li> <li>• 120 VDC</li> <li>• 240 VDC</li> </ul>	<ul style="list-style-type: none"> <li>• Typ. 40 ms</li> <li>• Typ. 30 ms</li> <li>• Typ. 25 ms</li> <li>• Typ. 20 ms</li> </ul> <ul style="list-style-type: none"> <li>• Typ. 45 ms</li> <li>• Typ. 70 ms</li> <li>• Typ. 60 ms</li> <li>• Typ. 75 ms</li> </ul>
Line length (unshielded)	Max. 100 m
<b>Digital outputs</b>	
Number	4
Output type	Relay outputs
Electrical isolation	Yes
In groups of	1
Control of a digital input	Yes
Continuous current $I_{th}$	Recommended range of application $\geq 100$ mA at 12 VAC/VDC Max. 5 A per relay
Relay rated voltage	240 VAC/VDC
Surge current	Max. 30 A
Incandescent lamp load (25000 switching cycles) at: 230/240 VAC 100/120 VAC	1000 W 500 W
Fluorescent tubes with ballast (25000 switching cycles)	10 x 58 W (at 230/240 VAC)
Fluorescent tubes, conventionally compensated (25000 switching cycles)	1 x 58 W (at 230/240 VAC)
Fluorescent tubes, uncompensated (25000 switching cycles)	10 x 58 W (at 230/240 VAC)
Short circuit-proof cos 1	Power protection B16, 600 A
Short circuit-proof cos 0.5 to 0.7	Power protection B16, 900 A
Derating	None; across the entire temperature range
Parallel output circuits for power increase	Not permitted

	<b>FL1F-M08C2R2</b>
Protection of output relay (if desired)	Max. 16 A, characteristic B16
<b>Switching rate</b>	
Mechanical	10 Hz
Ohmic load/lamp load	2 Hz
Inductive load	0.5 Hz

Notice: For fluorescent lamps with capacitors, you must consider the technical data of fluorescent lamp ballasts. If the current exceeds the maximum allowed surge current, appropriate contactor relays must switch the fluorescent lamps.

## A.4 Technical data: FL1F-H12SCD

	<b>FL1F-H12SCD</b>
<b>Power supply</b>	
Input voltage	24 VDC
Permissible range	20.4 VDC to 28.8 VDC
Reverse polarity protection	Yes
Permissible mains frequency	--
Power consumption from 24 VDC	25 mA to 50 mA (no load on digital output) 1.2 A (with max. load on digital output)
Voltage failure buffering	--
Power loss at 24 VDC	0.6 W to 1.2 W
Backup of the real-time clock at 25 °C	Typ. 20 days
Accuracy of the real-time clock	Typ. ± 2 s/day
<b>Digital inputs</b>	
Number	8
Electrical isolation	No
Number of high speed inputs	4 (I3, I4, I5, I6)
Input frequency	<ul style="list-style-type: none"> <li>• Normal input</li> <li>• High speed input</li> </ul>
	<ul style="list-style-type: none"> <li>• Max. 4 Hz</li> <li>• Max. 5 kHz</li> </ul>
Max. continuous permissible voltage	28.8 VDC
Input voltage	L+
Signal 0	< 5 VDC
Signal 1	> 12 VDC
Input current at	
Signal 0	< 0.9 mA (I3 to I6) < 0.07 mA (I1, I2, I7, I8)
Signal 1	> 2.1 mA (I3 to I6) > 0.18 mA (I1, I2, I7, I8)
Delay time at	
0 to 1	<ul style="list-style-type: none"> <li>• Typ. 1.5 ms</li> <li>• &lt;1.0 ms (I3 to I6)</li> </ul>
1 to 0	<ul style="list-style-type: none"> <li>• Typ. 1.5 ms</li> <li>• &lt;1.0 ms (I3 to I6)</li> </ul>

FL1F-H12SCD	
Line length (unshielded)	Max. 100 m
<b>Analog inputs</b>	
Number	4 (I1=AI3, I2=AI4, I7=AI1, I8=AI2)
Range	0 VDC to 10 VDC Input impedance 80 kΩ
Cycle time for analog value generation	300 ms
Line length (shielded and twisted)	Max. 10 m
Error limit	± 1.5% at FS
<b>Digital outputs</b>	
Number	4
Output type	Transistor, current-sourcing <sup>1)</sup>
Electrical isolation	No
In groups of	--
Control of a digital input	Yes
Output voltage	≤ Supply voltage
Output current	Max. 0.3 A per channel
Short circuit-proof and overload-proof	Yes
Short circuit current limitation	Approx. 1 A per channel
Derating	None; across the entire temperature range
Short circuit-proof cos 1	--
Short circuit-proof cos 0.5 to 0.7	--
Parallel output circuit for power increase	Not permitted
Protection of output relay (if desired)	--
<b>Switching rate <sup>2)</sup></b>	
Mechanical	--
Electrical	10 Hz
Ohmic load/lamp load	10 Hz
Inductive load	0.5 Hz

1) When you switch on FL1F-H12SCD or FL1F-M08B1S2, the CPU sends signal 1 to the digital outputs for about 50 μs. Take this into account, especially when using devices that react to short pulses.

2) The maximum switching rate is only dependent on the switching program's cycle time.

## A.5 Technical data: FL1F-M08B1S2

FL1F-M08B1S2	
<b>Power supply</b>	
Input voltage	24 VDC
Permissible range	20.4 VDC to 28.8 VDC
Reverse polarity protection	Yes
Permissible mains frequency	--
Power consumption from 24 VDC	25 mA to 40 mA (no load on digital output) 1.2 A (with max. load on digital output )

<b>FL1F-M08B1S2</b>	
Power loss at 24 V	0.6 W to 1.0 W
<b>Digital inputs</b>	
Number	4
Electrical isolation	No
Number of high speed inputs	0
Input frequency	<ul style="list-style-type: none"> <li>• Normal input</li> <li>• High speed input</li> </ul>
	<ul style="list-style-type: none"> <li>• Max. 4 Hz</li> <li>• --</li> </ul>
Max. continuous permissible voltage	28.8 VDC
Input voltage	L+
	<ul style="list-style-type: none"> <li>• &lt; 5 VDC</li> <li>• &gt; 12 VDC</li> </ul>
Input current at	
	<ul style="list-style-type: none"> <li>• Signal 0</li> <li>• Signal 1</li> </ul>
	<ul style="list-style-type: none"> <li>• &lt; 0.88 mA</li> <li>• &gt; 2.1 mA</li> </ul>
Delay time at	
	<ul style="list-style-type: none"> <li>• 0 to 1</li> <li>• 1 to 0</li> </ul>
	<ul style="list-style-type: none"> <li>• Typ. 1.5 ms</li> <li>• Typ. 1.5 ms</li> </ul>
Line length (unshielded)	Max. 100 m
<b>Digital outputs</b>	
Number	4
Output type	Transistor, current-sourcing <sup>1)</sup>
Electrical isolation	No
In groups of	--
Control of a digital input	Yes
Output voltage	≤ Supply voltage
Output current	Max. 0.3 A per channel
Short circuit-proof and overload-proof	Yes
Short circuit current limitation	Approx. 1 A per channel
Derating	None; across the entire temperature range
Short circuit-proof cos 1	--
Short circuit-proof cos 0.5 to 0.7	--
Parallel output circuit for power increase	Not permitted
Protection of output relay (if desired)	--
<b>Switching rate</b>	
Mechanical	--
Electrical	10 Hz
Ohmic load/lamp load	10 Hz
Inductive load	0.5 Hz

<sup>1)</sup> When you switch on FL1F-H12SCD or FL1F-M08B1S2, the CPU sends signal 1 to the digital outputs for about 50 μs. Take this into account, especially when using devices that react to short pulses.



## A.6 Technical data: FL1F-H12RCA/B12RCA

	FL1F-H12RCA FL1F-B12RCA
<b>Power supply</b>	
Input voltage	24 VAC/VDC
Permissible range	20.4 VAC to 26.4 VAC 20.4 VDC to 28.8 VDC
Reverse polarity protection	--
Permissible mains frequency	47 Hz to 63 Hz
Power consumption	<ul style="list-style-type: none"> <li>• 24 VAC</li> <li>• 24 VDC</li> </ul>
	<ul style="list-style-type: none"> <li>• 60 mA to 185 mA</li> <li>• 25 mA to 100 mA</li> </ul>
Voltage failure buffering	Typ. 5 ms
Power loss	<ul style="list-style-type: none"> <li>• 24 VAC</li> <li>• 24 VDC</li> </ul>
	<ul style="list-style-type: none"> <li>• 1.4 W to 4.4 W</li> <li>• 0.6 W to 2.4 W</li> </ul>
Backup of the real-time clock at 25 °C	Typ. 20 days
Accuracy of the real-time clock	Typ. ± 2 s/day
<b>Digital inputs</b>	
Number	8, optional positive voltage or negative voltage
Electrical isolation	No
Number of high speed inputs	0
Input frequency	<ul style="list-style-type: none"> <li>• Normal input</li> <li>• High speed input</li> </ul>
	<ul style="list-style-type: none"> <li>• Max. 4 Hz</li> <li>• --</li> </ul>
Max. continuous permissible voltage	26.4 VAC 28.8 VDC
Input voltage	L
<ul style="list-style-type: none"> <li>• Signal 0</li> <li>• Signal 1</li> </ul>	<ul style="list-style-type: none"> <li>• &lt; 5 VAC/VDC</li> <li>• &gt; 12 VAC/VDC</li> </ul>
Input current at	
<ul style="list-style-type: none"> <li>• Signal 0</li> <li>• Signal 1</li> </ul>	<ul style="list-style-type: none"> <li>• &lt; 1.2 mA</li> <li>• &gt; 2.6 mA</li> </ul>
Delay time at	
<ul style="list-style-type: none"> <li>• 0 to 1</li> <li>• 1 to 0</li> </ul>	<ul style="list-style-type: none"> <li>• Typ. 1.5 ms</li> <li>• Typ. 15 ms</li> </ul>
Line length (unshielded)	Max. 100 m
<b>Analog inputs</b>	
Number	--
Range	--
max. Input voltage	--
<b>Digital outputs</b>	
Number	4
Output type	Relay outputs
Electrical isolation	Yes
In groups of	1

	FL1F-H12RCA FL1F-B12RCA
Control of a digital input	Yes
Continuous current $I_{th}$	Recommended range of application $\geq 100$ mA at 12 VAC/VDC Max. 10 A per relay
Relay rated voltage	240 VAC/VDC
Surge current	Max. 30 A
Incandescent lamp load (25000 switching cycles) at	1000 W
Fluorescent tubes with ballast (25000 switching cycles)	10 x 58 W
Fluorescent tubes, conventionally compensated (25000 switching cycles)	1 x 58 W
Fluorescent tubes, uncompensated (25000 switching cycles)	10 x 58 W
Derating	None; across the entire temperature range
Short circuit-proof cos 1	Power protection B16, 600 A
Short circuit-proof cos 0.5 to 0.7	Power protection B16, 900 A
Parallel output circuits for power increase	Not permitted
Protection of output relay (if desired)	Max. 16 A, characteristic B16
<b>Switching rate</b>	
Mechanical	10 Hz
Ohmic load/lamp load	2 Hz
Inductive load	0.5 Hz

Notice: For fluorescent lamps with capacitors, you must consider the technical data of fluorescent lamp ballasts. If the current exceeds the maximum allowed surge current, appropriate contactor relays must switch the fluorescent lamps.

## A.7 Technical data: FL1F-M08D2R2

	FL1F-M08D2R2
<b>Power supply</b>	
Input voltage	24 VAC/VDC
Permissible range	20.4 VAC to 26.4 VAC 20.4 VDC to 28.8 VDC
Reverse polarity protection	--
Permissible mains frequency	47 Hz to 63 Hz
Power consumption	<ul style="list-style-type: none"> <li>• 24 VAC</li> <li>• 24 VDC</li> </ul>
	<ul style="list-style-type: none"> <li>• 40 mA to 110 mA</li> <li>• 15 mA to 50 mA</li> </ul>
Voltage failure buffering	Typ. 5 ms
Power loss	<ul style="list-style-type: none"> <li>• 24 VAC</li> <li>• 24 VDC</li> </ul>
	<ul style="list-style-type: none"> <li>• 1.0 W to 2.6 W</li> <li>• 0.4 W to 1.2 W</li> </ul>
<b>Digital inputs</b>	
Number	4, optional positive voltage or negative voltage
Electrical isolation	No
Number of high speed inputs	0
Input frequency	<ul style="list-style-type: none"> <li>• Normal input</li> <li>• High speed input</li> </ul>
	<ul style="list-style-type: none"> <li>• Max. 4 Hz</li> <li>• --</li> </ul>
Max. continuous permissible voltage	<ul style="list-style-type: none"> <li>• 26.4 VAC</li> <li>• 28.8 VDC</li> </ul>
Input voltage	L
<ul style="list-style-type: none"> <li>• Signal 0</li> <li>• Signal 1</li> </ul>	<ul style="list-style-type: none"> <li>• &lt; 5 VAC/VDC</li> <li>• &gt; 12 VAC/VDC</li> </ul>
Input current at	<ul style="list-style-type: none"> <li>• Signal 0</li> <li>• Signal 1</li> </ul>
	<ul style="list-style-type: none"> <li>• &lt; 1.1 mA</li> <li>• &gt; 2.63 mA</li> </ul>
Delay time at	<ul style="list-style-type: none"> <li>• 0 to 1</li> <li>• 1 to 0</li> </ul>
	<ul style="list-style-type: none"> <li>• Typ. 1.5 ms</li> <li>• Typ. 15 ms</li> </ul>
Line length (unshielded)	Max. 100 m
<b>Digital outputs</b>	
Number	4
Output type	Relay outputs
Electrical isolation	Yes
In groups of	1
Control of a digital input	Yes
Continuous current $I_{th}$	Recommended range of application $\geq 100$ mA at 12 VAC/VDC Max. 5 A per relay
Relay rated voltage	240 VAC/VDC
Surge current	Max. 30 A

	FL1F-M08D2R2
Incandescent lamp load (25000 switching cycles) at	1000 W
Fluorescent tubes with ballast (25000 switching cycles)	10 x 58 W
Fluorescent tubes, conventionally compensated (25000 switching cycles)	1 x 58 W
Fluorescent tubes, uncompensated (25000 switching cycles)	10 x 58 W
Derating	None; across the entire temperature range
Short circuit-proof cos 1	Power protection B16, 600 A
Short circuit-proof cos 0.5 to 0.7	Power protection B16, 900 A
Parallel output circuits for power increase	Not permitted
Protection of output relay (if desired)	Max. 16 A, characteristic B16
<b>Switching rate</b>	
Mechanical	10 Hz
Ohmic load/lamp load	2 Hz
Inductive load	0.5 Hz

Notice: For fluorescent lamps with capacitors, you must consider the technical data of fluorescent lamp ballasts. If the current exceeds the maximum allowed surge current, appropriate contactor relays must switch the fluorescent lamps.

## A.8 Technical data: FL1F-B12RCE/H12RCE, FL1F-M08B2R2

	FL1F-B12RCE FL1F-H12RCE	FL1F-M08B2R2
<b>Power supply</b>		
Input voltage	12/24 VDC	12/24 VDC
Permissible range	10.8 VDC to 28.8 VDC	10.8 VDC to 28.8 VDC
Reverse polarity protection	Yes	Yes
Power consumption		
<ul style="list-style-type: none"> <li>• 12 VDC</li> <li>• 24 VDC</li> </ul>	<ul style="list-style-type: none"> <li>• 50 mA to 165 mA</li> <li>• 25 mA to 90 mA</li> </ul>	<ul style="list-style-type: none"> <li>• 20 mA to 90 mA</li> <li>• 15 mA to 50 mA</li> </ul>
Voltage failure buffering		
<ul style="list-style-type: none"> <li>• 12 VDC</li> <li>• 24 VDC</li> </ul>	<ul style="list-style-type: none"> <li>• Typ. 2 ms</li> <li>• Typ. 5 ms</li> </ul>	<ul style="list-style-type: none"> <li>• Typ. 2 ms</li> <li>• Typ. 5 ms</li> </ul>
Power loss		
<ul style="list-style-type: none"> <li>• 12 VDC</li> <li>• 24 VDC</li> </ul>	<ul style="list-style-type: none"> <li>• 0.6 W to 2.0 W</li> <li>• 0.6 W to 2.2 W</li> </ul>	<ul style="list-style-type: none"> <li>• 0.2 W to 1.1 W</li> <li>• 0.4 W to 1.2 W</li> </ul>
Backup of the real-time clock at 25 °C	Typ. 20 days	--
Accuracy of the real-time clock	Typ. ± 2 s/day	--
Electrical isolation	No	No
<b>Digital inputs</b>		
Number	8	4
Electrical isolation	No	No
Number of high speed inputs	4 (I3, I4, I5, I6)	0
Input frequency		
<ul style="list-style-type: none"> <li>• Normal input</li> <li>• High speed input</li> </ul>	<ul style="list-style-type: none"> <li>• Max. 4 Hz</li> <li>• Max. 5 kHz</li> </ul>	<ul style="list-style-type: none"> <li>• Max. 4 Hz</li> <li>• --</li> </ul>
Max. continuous permissible voltage	28.8 VDC	28.8 VDC
Input voltage L+		
<ul style="list-style-type: none"> <li>• Signal 0</li> <li>• Signal 1</li> </ul>	<ul style="list-style-type: none"> <li>• &lt; 5 VDC</li> <li>• &gt; 8.5 VDC</li> </ul>	<ul style="list-style-type: none"> <li>• &lt; 5 VDC</li> <li>• &gt; 8.5 VDC</li> </ul>
Input current at		
<ul style="list-style-type: none"> <li>• Signal 0</li> <li>• Signal 1</li> </ul>	<ul style="list-style-type: none"> <li>&lt; 0.88 mA (I3 to I6)</li> <li>&lt; 0.07 mA (I1, I2, I7, I8)</li> <li>&gt; 1.5 mA (I3 to I6)</li> <li>&gt; 0.12 mA (I1, I2, I7, I8)</li> </ul>	<ul style="list-style-type: none"> <li>&lt; 0.88 mA</li> <li>&gt; 1.5 mA</li> </ul>
Delay time at		
<ul style="list-style-type: none"> <li>• 0 to 1</li> <li>• 1 to 0</li> </ul>	<ul style="list-style-type: none"> <li>• Typ. 1.5 ms</li> <li>&lt;1.0 ms (I3 to I6)</li> <li>• Typ. 1.5 ms</li> <li>&lt;1.0 ms (I3 to I6)</li> </ul>	<ul style="list-style-type: none"> <li>• Typ. 1.5 ms</li> <li>• Typ. 1.5 ms</li> </ul>
Line length (unshielded)	Max. 100 m	Max. 100 m
<b>Analog inputs</b>		
Number	4 (I1=AI3, I2=AI4, I7=AI1, I8=AI2)	--
Range	0 VDC to 10 VDC Input impedance 80 kΩ	--
Cycle time for analog value generation	300 ms	--

	FL1F-B12RCE FL1F-H12RCE	FL1F-M08B2R2
Line length (shielded and twisted)	Max. 10 m	--
Error limit	± 1.5% at FS	--
<b>Digital outputs</b>		
Number	4	4
Output type	Relay outputs	Relay outputs
Electrical isolation	Yes	Yes
In groups of	1	1
Control of a digital input	Yes	Yes
Continuous current $I_{th}$ (per terminal)	Recommended range of application $\geq 100$ mA at 12 VAC/VDC Max. 10 A per relay	Recommended range of application $\geq 100$ mA at 12 VAC/VDC Max. 5 A per relay
Relay rated voltage	240 VAC/VDC	240 VAC/VDC
Surge current	Max. 30 A	Max. 30 A
Incandescent lamp load (25000 switching cycles) at	1000 W	1000 W
Fluorescent tubes with ballast (25000 switching cycles)	10 x 58 W	10 x 58 W
Fluorescent tubes, conventionally compensated (25000 switching cycles)	1 x 58 W	1 x 58 W
Fluorescent tubes, uncompensated (25000 switching cycles)	10 x 58 W	10 x 58 W
Derating	None; across the entire temperature range	None; across the entire temperature range
Short circuit-proof cos 1	Power protection B16, 600 A	Power protection B16, 600 A
Short circuit-proof cos 0.5 to 0.7	Power protection B16, 900 A	Power protection B16, 900 A
Parallel output circuits for power increase	Not permitted	Not permitted
Protection of output relay (if desired)	Max. 16 A, characteristic B16	Max. 16 A, characteristic B16
<b>Switching rate</b>		
Mechanical	10 Hz	10 Hz
Ohmic load/lamp load	2 Hz	2 Hz
Inductive load	0.5 Hz	0.5 Hz

Notice: For fluorescent lamps with capacitors, you must consider the technical data of fluorescent lamp ballasts. If the current exceeds the maximum allowed surge current, appropriate contactor relays must switch the fluorescent lamps.

## A.9 Switching capacity/service life of the relay outputs

### Switching capacity and service life of the contacts with ohmic loading (heating):

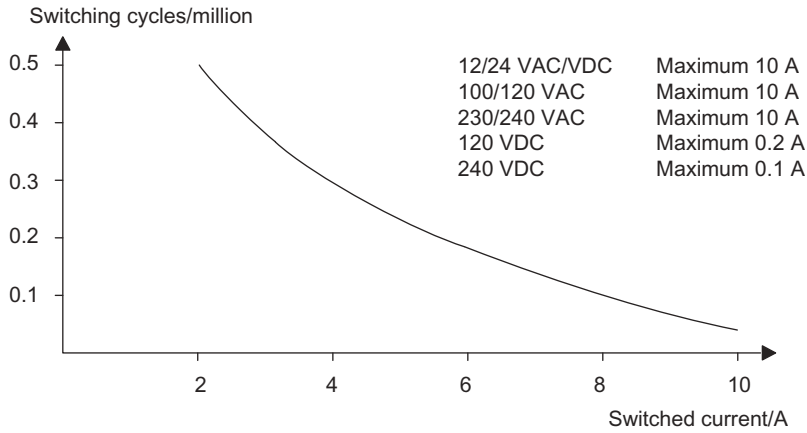

### Switching capacity and service life of the contacts with high inductive load to IEC 60947-5-1 DC 13/AC 15 (contactors, solenoid coils, motors):

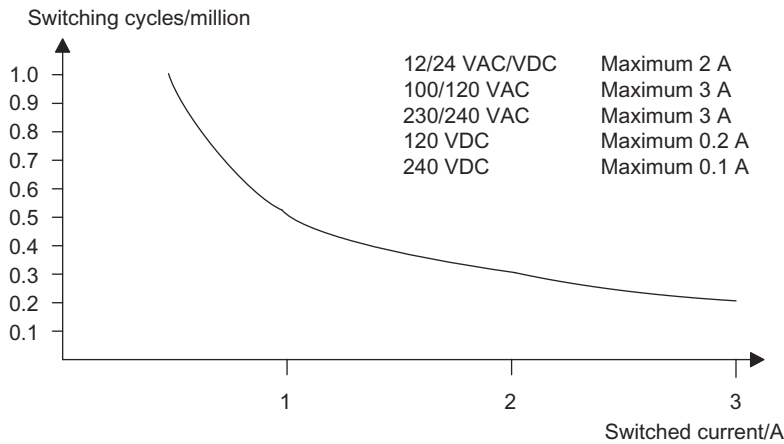

**Note**

To ensure the switching capacity and service life, keep the minimum switching load of the relay outputs at 100 mA with the voltage of 12 VAC-/VDC.

## A.10 Technical data: FL1F-J2B2

FL1F-J2B2	
<b>Power supply</b>	
Input voltage	12/24 VDC
Permissible range	10.8 VDC to 28.8 VDC
Power consumption	25 mA to 30 mA
Voltage failure buffering	Typ. 10 ms
Power loss at	
• 12 VDC	• 0.3 W to 0.4 W
• 24 VDC	• 0.6 W to 0.7 W
Electrical isolation	No
Reverse polarity protection	Yes
Ground terminal	For connecting ground and shielding of the analog measuring line
<b>Analog inputs</b>	
Number	2
Type	Unipolar
Input range	0 VDC to 10 VDC (input impedance 76 kΩ) or 0/4 mA to 20 mA (input impedance <250 Ω)
Resolution	10 bit, normalized to 0 to 1000
Cycle time for analog value generation	50 ms
Electrical isolation	No
Line length (shielded and twisted)	Max. 10 m
Encoder supply voltage	None
Error limit	± 1.5%
Interference frequency suppression	55 Hz



## A.11 Technical data: FL1F-K2BM2

	FL1F-K2BM2
<b>Power supply</b>	
Input voltage	24 VDC
Permissible range	20.4 VDC to 28.8 VDC
Power consumption	30 mA to 82 mA
Voltage failure buffering	Typ. 10 ms
Power loss at 24 VDC	0.7 W to 2.0 W
Electrical isolation	No
Reverse polarity protection	Yes
Ground terminal	For connecting ground and shielding of the analog output line.
<b>Analog outputs</b>	
Number	2
Voltage range	0 VDC to 10 VDC
Voltage load	≥ 5 kΩ
Current output	0/4 mA to 20 mA
Current load	≤ 250 Ω
Resolution	10 bit, normalized to 0 to 1000
Cycle time for analog output	Depending on installation (50 ms)
Electrical isolation	No
Line length (shielded and twisted)	Max. 10 m
Error limit	Voltage output: ± 2.5% FS
Short circuit protection	Voltage output: Yes
Overload protection	Current output: Yes Voltage output: Yes

## A.12 Technical data: IDEC SmartRelay Power 24 V

IDEC SmartRelay Power 24 V is a primary.

## A.13 Technical data: FL1F-RD1 (Text Display with Ethernet interfaces)

FL1F-RD1	
<b>Mechanical data</b>	
Keyboard	Membrane keypad with 10 keys
Display	FSTN-Graphic Display with 160 x 96 (columns x rows), LED backlight (white/amber/red)
<b>Power supply</b>	
Input voltage	24 VAC/VDC 12 VDC
Permissible range	20.4 VAC to 26.4 VAC 10.2 VDC to 28.8 VDC
Permissible mains frequency	47Hz to 63 Hz
Power consumption (Ethernet and white backlight active)	<ul style="list-style-type: none"> <li>• 12 VDC</li> <li>• 24 VDC</li> <li>• 24 VAC</li> </ul>
	<ul style="list-style-type: none"> <li>• Typ. 150 mA</li> <li>• Typ. 75 mA</li> <li>• Typ. 145 mA</li> </ul>
<b>Degree of protection</b>	
	IP20 for FL1F-RD1 excluding front panel IP65 for FL1F-RD1 front panel
<b>Communication port</b>	
Ethernet performance	Two Ethernet interfaces with 10/100 M full/half duplex data transmission rate
Connection distance	Max. 30 m
<b>LCD Display and Backlight</b>	
Backlight lifetime <sup>1)</sup>	20,000 hours
Display lifetime <sup>2)</sup>	50,000 hours
<b>Mounting</b>	
Mounting hole dimensions (WxH)	(119 + 0.5 mm) x (78.5 + 0.5 mm)
Mounting conditions	Mount the FL1F-RD1 vertically on a flat surface of an IP 65 or Type 4x/12 enclosure.

<sup>1)</sup> The backlight lifetime is when the final brightness is 50% of the original brightness.

<sup>2)</sup> The display lifetime is calculated under ordinary operating and storage conditions: room temperature (20 ± 8 °C), normal humidity below 65% relative humidity, and not in exposure to direct sunlight.



## Determining the cycle time

The program cycle is the complete execution of the circuit program, that is, primarily the reading in of the inputs, the processing of the circuit program and the subsequent writing the outputs. The cycle time is the time required to execute a circuit program once in full.

You can determine the time required for a program cycle using a short test program. Create this test program in IDEC SmartRelay to return a value from which you can calculate the cycle time.

### Test program

To program this test program, follow these steps:

1. Create the test program by linking an output to a frequency trigger and connecting the trigger input with an inverted marker.

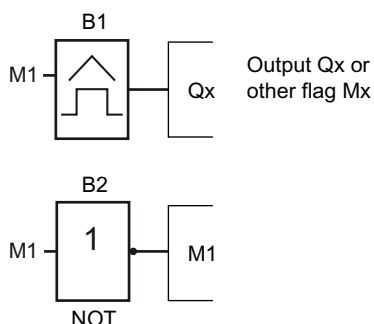

2. Configure the frequency trigger as shown below. IDEC SmartRelay generates a pulse in each program cycle due to the inverted marker. The trigger interval is 2 seconds.

B1	1/1	+/
On	=1000	
Off	=0	
G_T	=02:00s	

3. Now start the circuit program and switch IDEC SmartRelay to parameter assignment mode. In this mode, view the trigger parameters.

B1	1/1	
On	=1000	
Off	=0	
fa	=2130	← f <sub>a</sub> = total of measured pulses per timebase G_T

4. The reciprocal value of f<sub>a</sub> is equivalent to the IDEC SmartRelay execution time of the current circuit program in its memory.

$$1/f_a = \text{cycle time in s}$$

### Explanation

The inverted marker block changes its output signal at each program execution. Thus, one logic level (high or low) width is exactly equivalent to the length of one cycle. Hence, a period lasts two cycles.

The frequency trigger indicates the ratio of periods per two seconds, which results in the ratio of cycles per second.

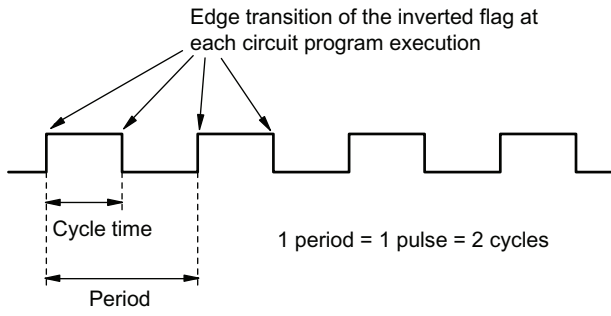

## IDEC SmartRelay without display ("IDEC SmartRelay Pure")

Because some specific applications do not require operator control or interface elements, such as buttons or a display, IDEC provides the FL1F-B12RCE, FL1F-B12RCA and FL1FB12RCC versions without display.

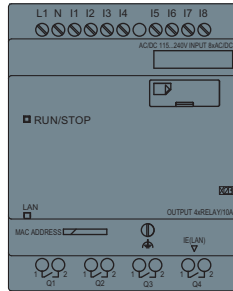

### Less is definitely more!

The versions without display offer you the following benefits:

- Even more cost-effective without the operating elements
- Requires less switch cabinet space than conventional hardware
- Substantial benefits with regard to flexibility and prime costs compared to stand-alone electronic switchgear
- Advantageous even for applications in which it replaces merely two or three conventional switching devices
- Very easy to use
- Access-protected
- Compatible to IDEC SmartRelay versions with display
- Offers the option to read data by means of WindLGC

### Creating a circuit program without operator panel

You can use one of two ways to create a circuit program for an IDEC SmartRelay without display:

- You create the circuit program with WindLGC on your PC and then download it to IDEC SmartRelay.
- You download the circuit program from a Using memory cards (Page 273) to your IDEC SmartRelay without display.

### Network communication indication

When you create a circuit program with WindLGC, you need to connect the module to your PC with an Ethernet cable. You can refer to the chapter Connecting the Ethernet interface (Page 43) to find the details about the wiring of the Ethernet interface and also about the status of the Ethernet LEDs.

## Operating characteristics

IDEC SmartRelay is ready for operation when you switch on power. Switching off an IDEC SmartRelay without display is equivalent to disconnecting the power supply.

You can not start or stop the circuit program of FL1F-B12... versions by means of buttons, therefore, this is why the FL1F-B12... versions have other startup characteristics.

## Startup characteristics

If there is no circuit program in IDEC SmartRelay or on the inserted micro SD card, IDEC SmartRelay remains in STOP mode.

If there is a valid circuit program in IDEC SmartRelay memory or on the micro SD card, IDEC SmartRelay automatically switches from STOP mode to RUN mode when you switch on power.

IDEC SmartRelay automatically copies the circuit program on an inserted micro SD card to memory, immediately after you switch on power. IDEC SmartRelay rewrites the existing circuit program in memory if one exists, and then changes from STOP mode to RUN mode.

By connecting an Ethernet cable to IDEC SmartRelay (Page 290), you can use WindLGC to download the circuit program and place IDEC SmartRelay in RUN mode.

## Operating status indication

An LED on the front panel indicates the operating state:

- Lights red: Power On/STOP
- Lights green: Power On/RUN

The LED lights red after Power On and in all IDEC SmartRelay states other than RUN mode. The LED lights green when IDEC SmartRelay is in RUN mode.

## Reading current data

WindLGC provides an online test for reading the current data of all functions while the system is in RUN.

If your IDEC SmartRelay without display holds a protected micro SD card, you cannot read the current data unless you Program copy protection (Page 284) for the circuit program. IDEC SmartRelay deletes the circuit program from memory when you remove the micro SD card.

## Deleting the circuit program

Use WindLGC to delete the circuit program and password if a password exists.

# IDEC SmartRelay menu structure

# D

## D.1 Base Module

### D.1.1 Menu overview

All of the following menu commands are valid for Base Modules with the ADMIN access level. If you operate the IDEC SmartRelay with the OP access level, some menu commands are invisible. For more information see section Overview of IDEC SmartRelay menus (Page 61).

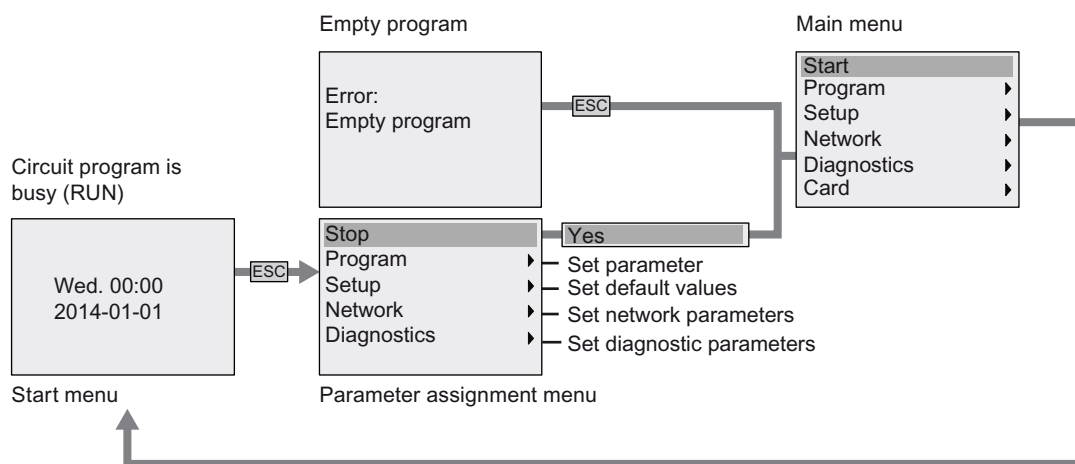

### D.1.2 Main menu

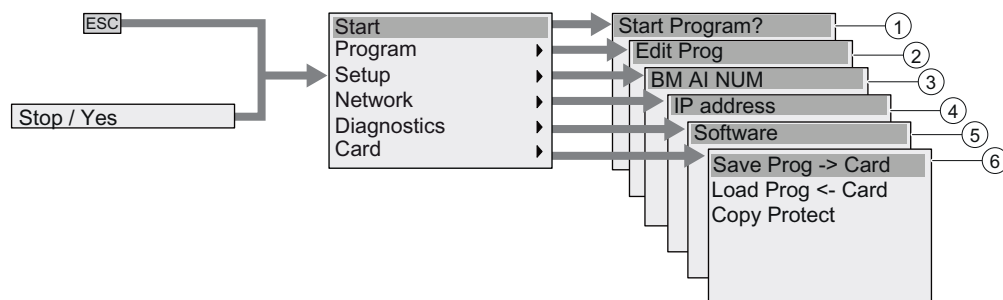

- |                                     |                                     |
|-------------------------------------|-------------------------------------|
| ① See "Start menu (Page 321)"       | ④ See "Network menu (Page 320)"     |
| ② See "Programming menu (Page 318)" | ⑤ See "Diagnostics menu (Page 320)" |
| ③ See "Setup menu (Page 319)"       | ⑥ See "Card menu (Page 318)"        |



### D.1.3 Programming menu

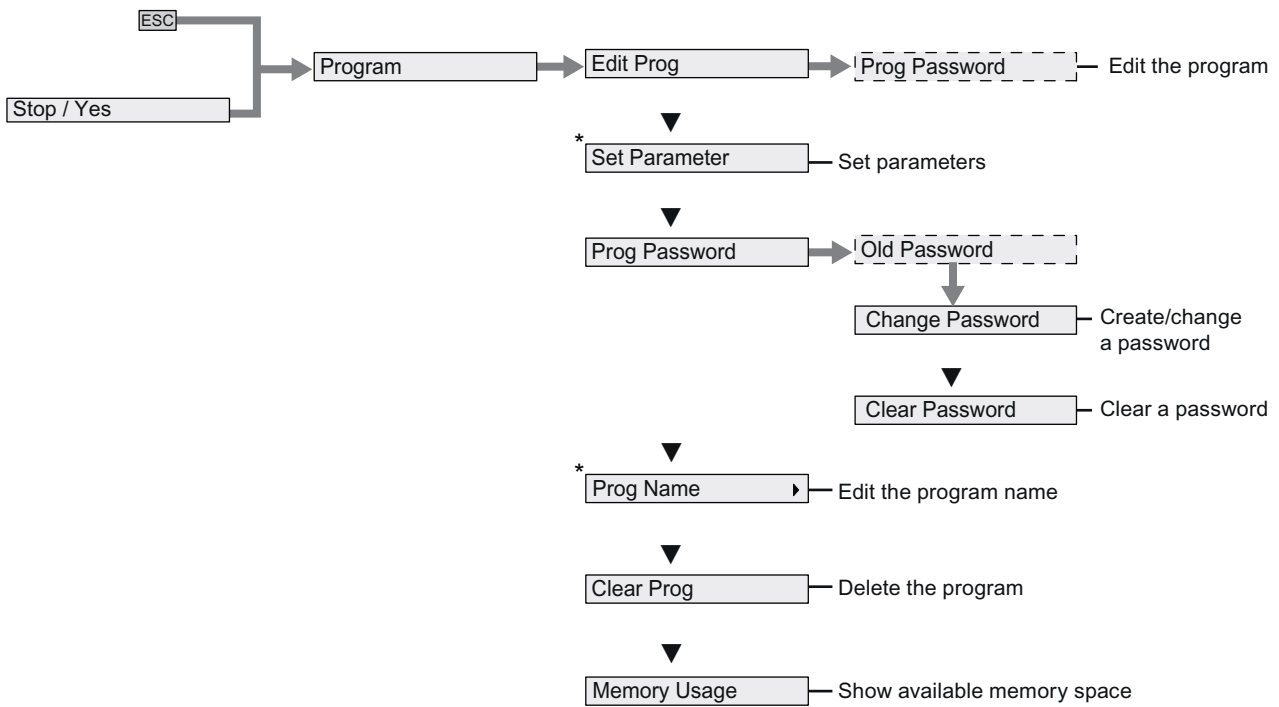

**Note**

When IDEC SmartRelay is in RUN mode, only the menu commands with an asterisk (\*) are available in the programming menu.

### D.1.4 Card menu

This menu is available only when IDEC SmartRelay is in programming mode.

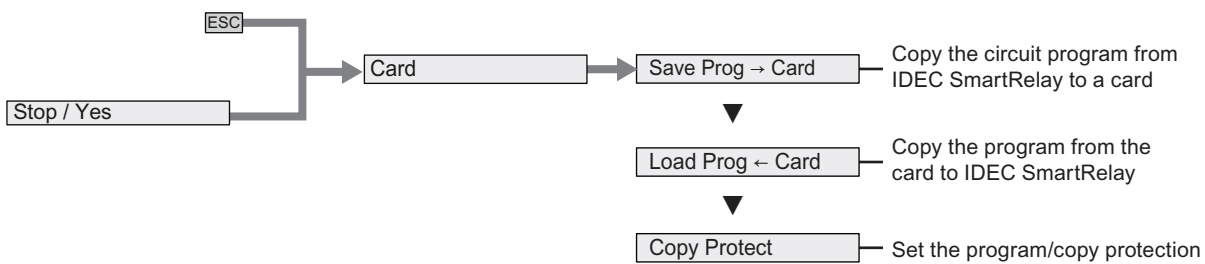

### D.1.5 Setup menu

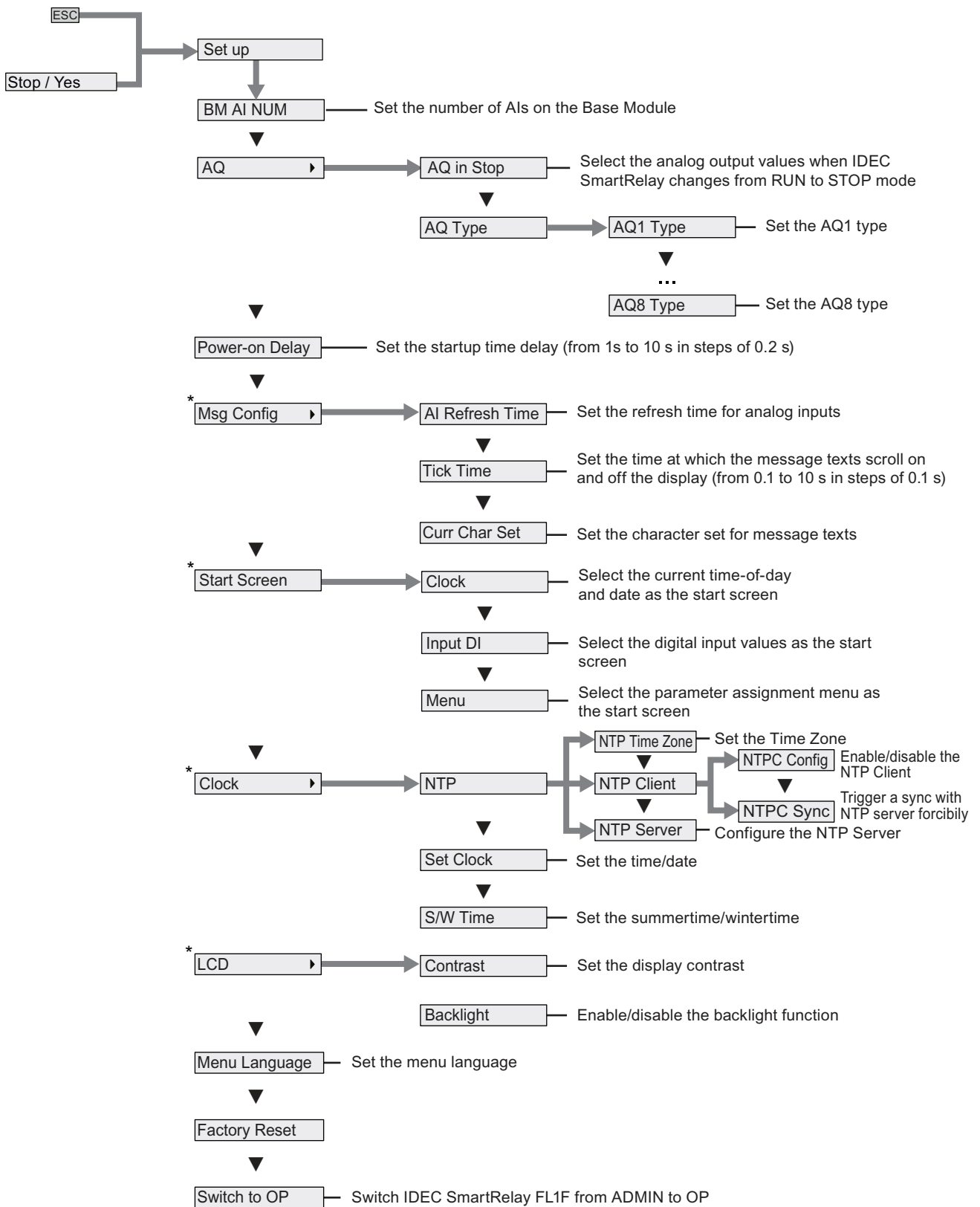

**Note**

When IDEC SmartRelay is in RUN mode, only the menu commands with an asterisk (\*) are available in the setup menu.

### D.1.6 Network menu

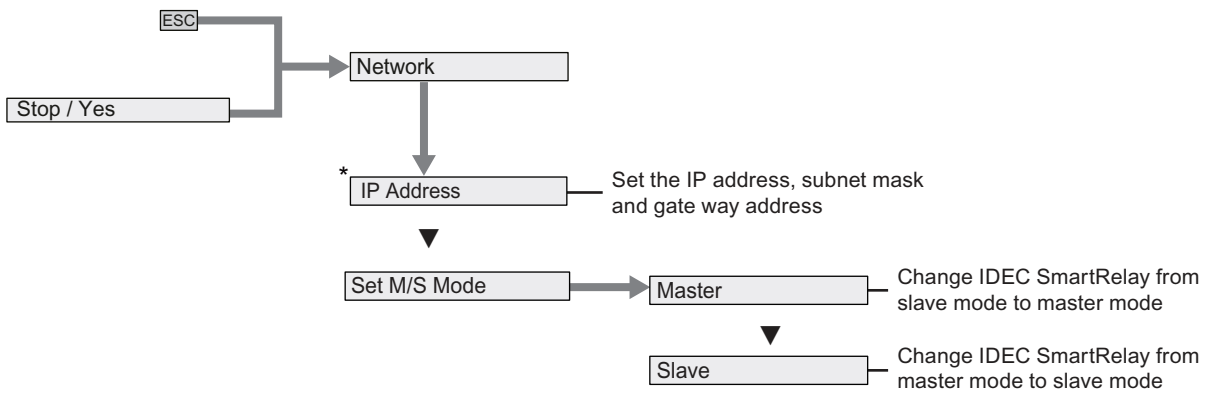

**Note**

When IDEC SmartRelay is in RUN mode, only the menu commands with an asterisk (\*) are available in the network menu.

### D.1.7 Diagnostics menu

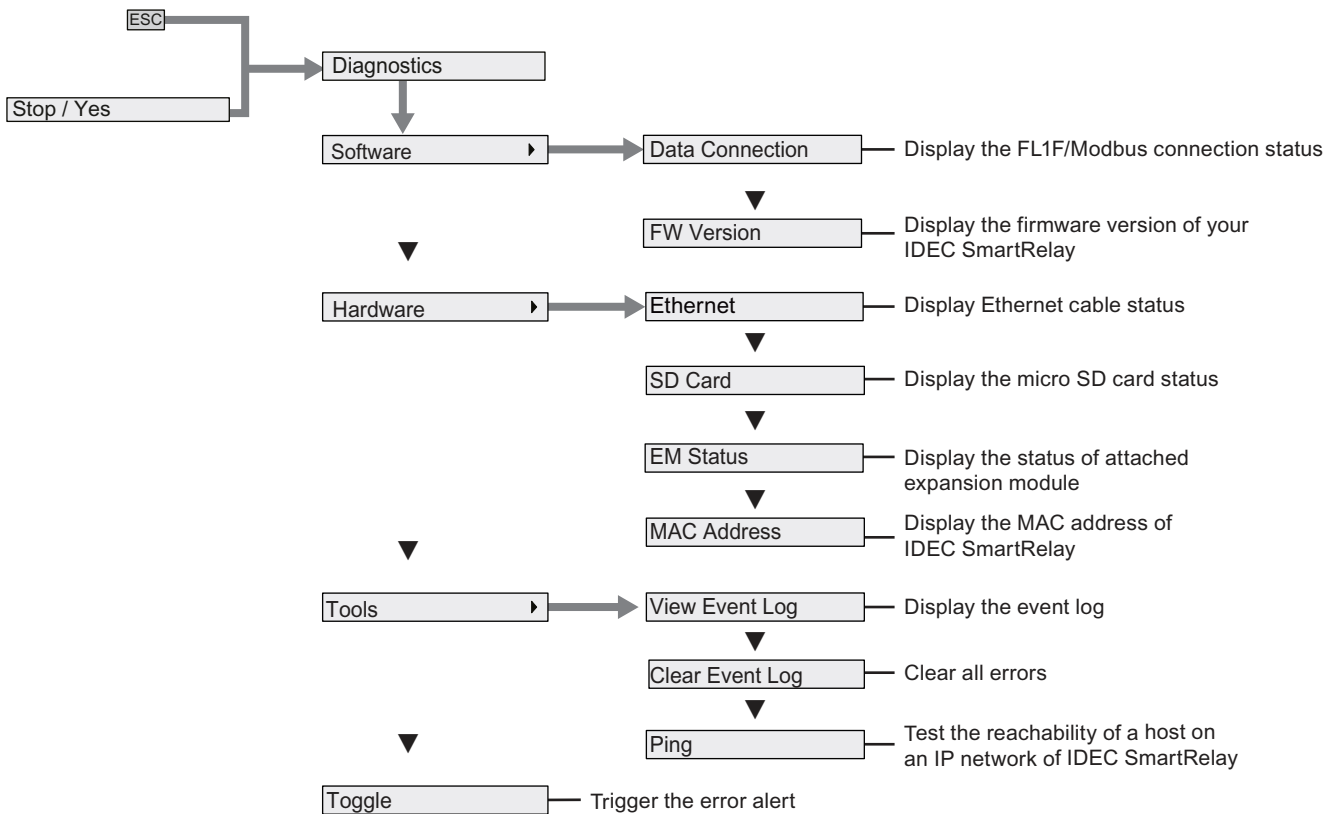

### D.1.8 Start menu

Parameter assignment menu

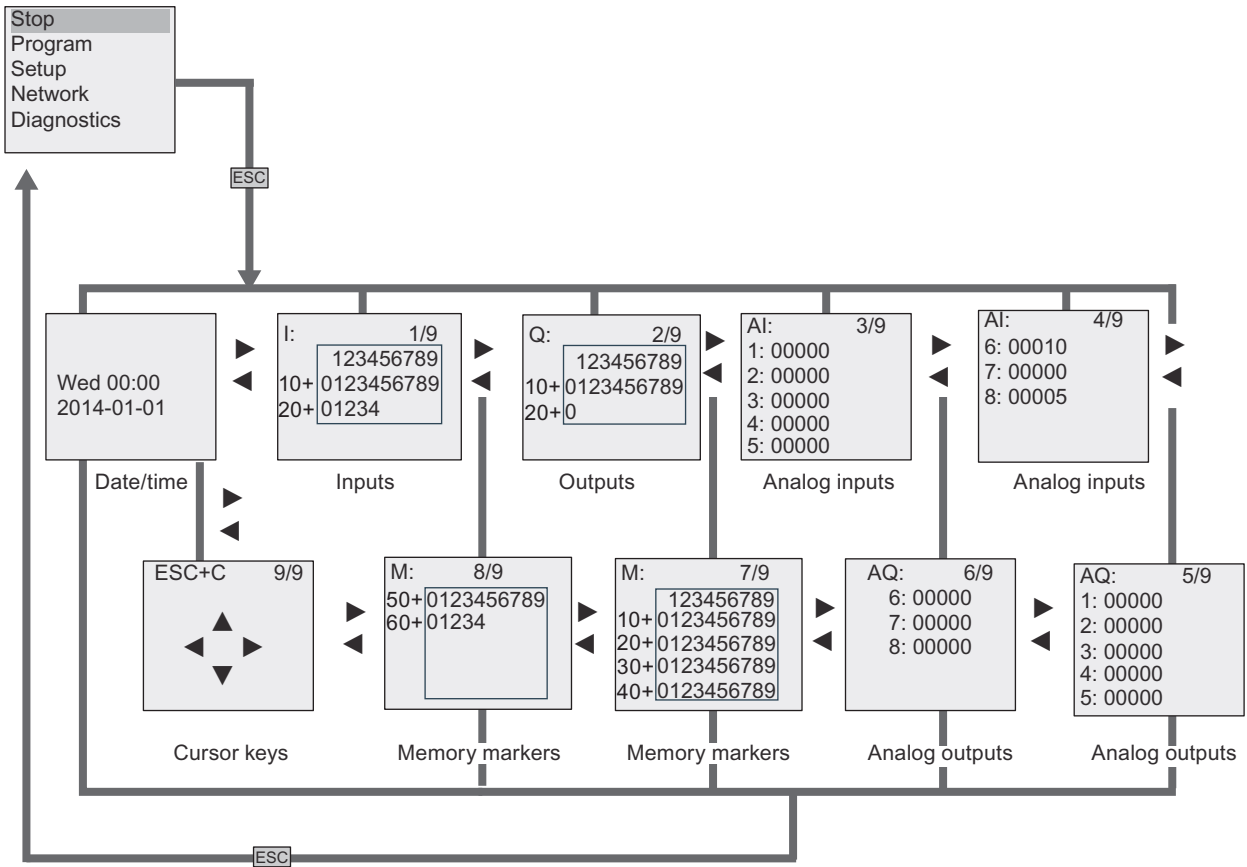

## D.2 Text Display

### D.2.1 Menu overview

All of the following menu commands are valid for the Text Display with the ADMIN access level. If you operate the Text Display with the OP access level, some menu commands are invisible. For more information, see section Overview of IDEC SmartRelay menus (Page 61).

Circuit program is busy (RUN)

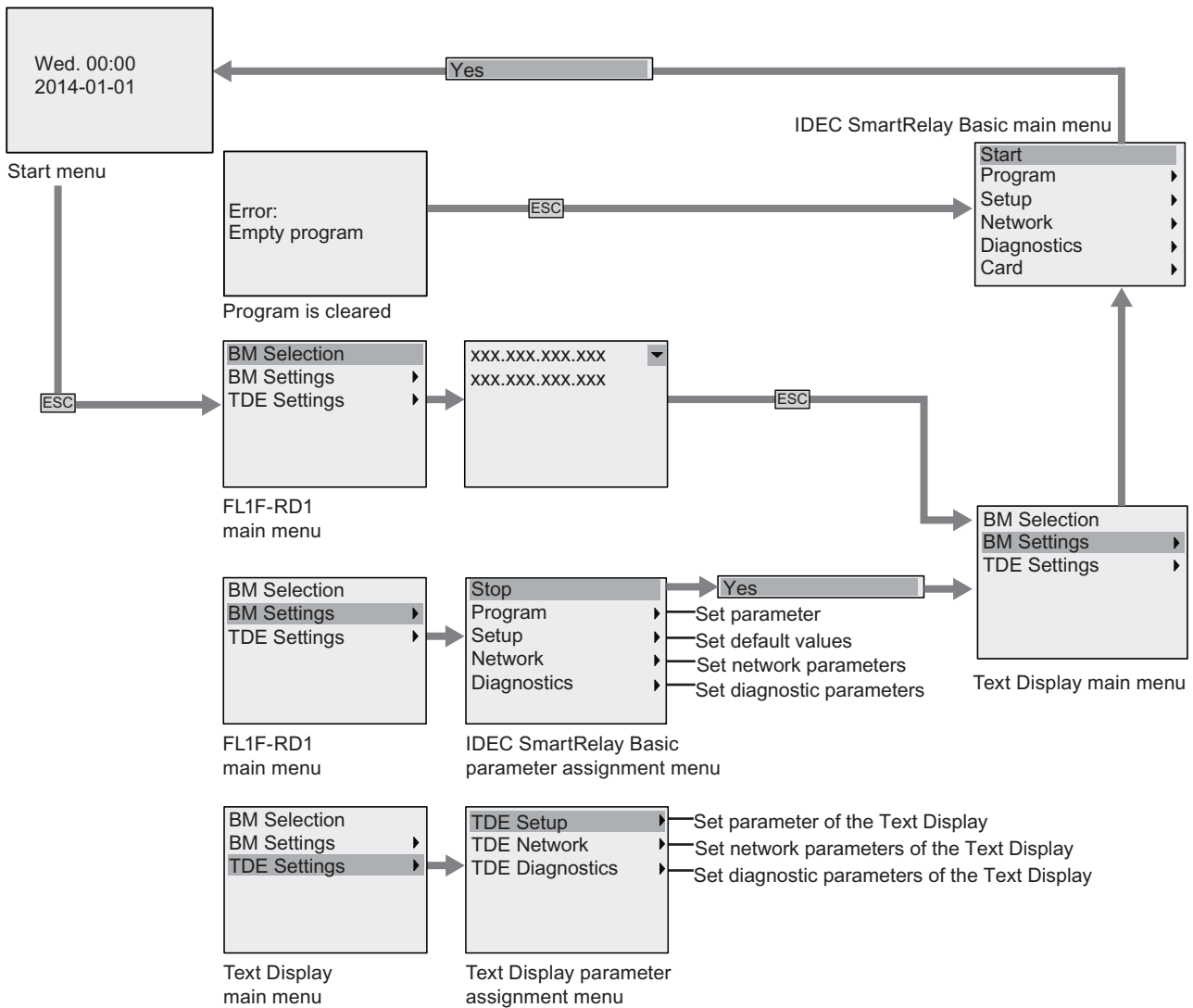

## D.2.2 Main menu

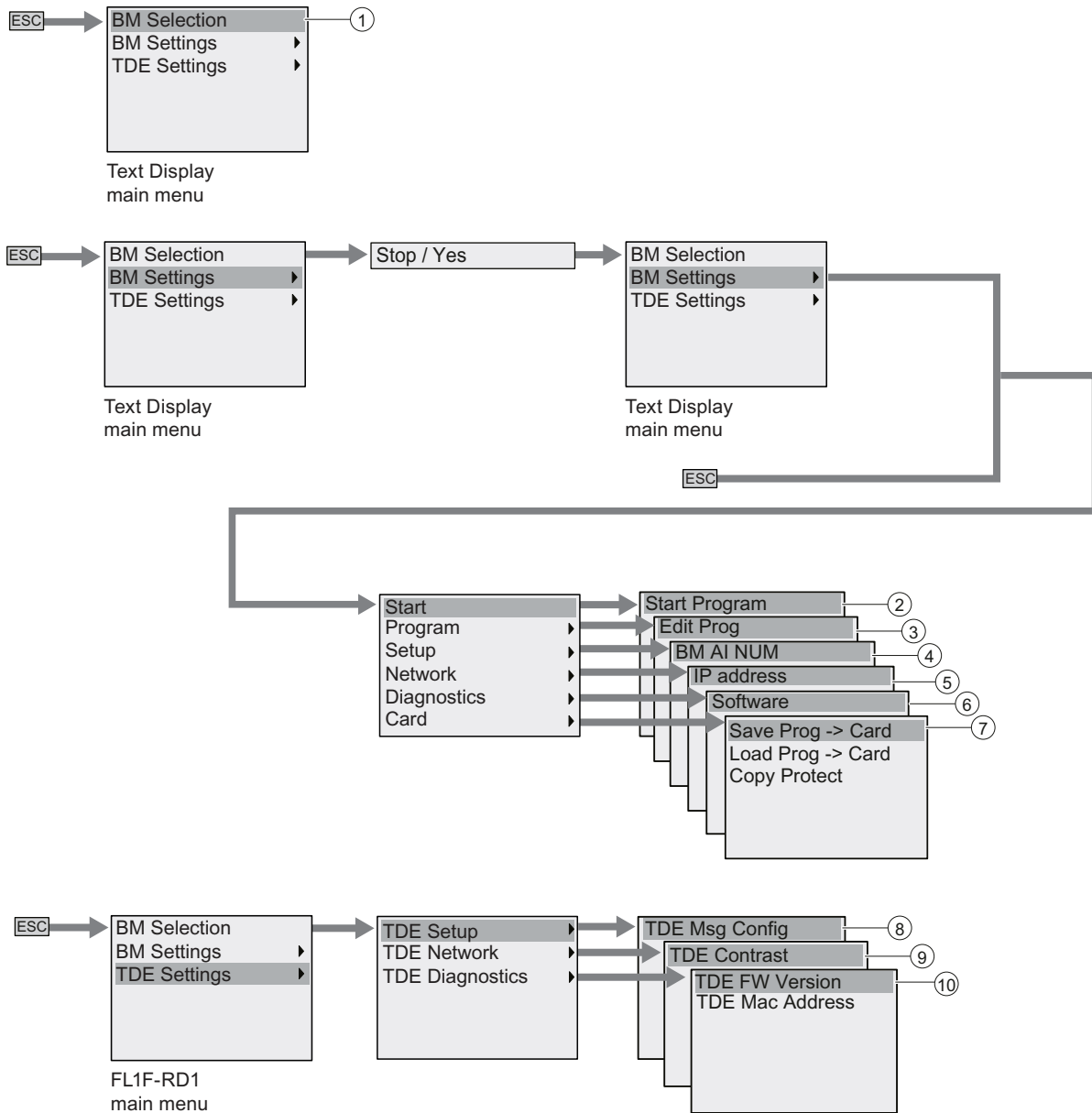

- |                                       |   |
|---------------------------------------|---|
| ① See "BM selection menu (Page 324)". | ⑥ See "Diagnostics menu (Page 320)".              |
| ② See "Setup menu (Page 319)".        | ⑦ See "Card menu (Page 318)".                     |
| ③ See "Programming menu (Page 318)".  | ⑧ See "Text Display setup menu (Page 327)".       |
| ④ See "Setup menu (Page 319)".        | ⑨ See "Text Display network menu (Page 327)".     |
| ⑤ See "Network menu (Page 320)".      | ⑩ See "Text Display diagnostics menu (Page 327)". |

### D.2.3 BM selection menu

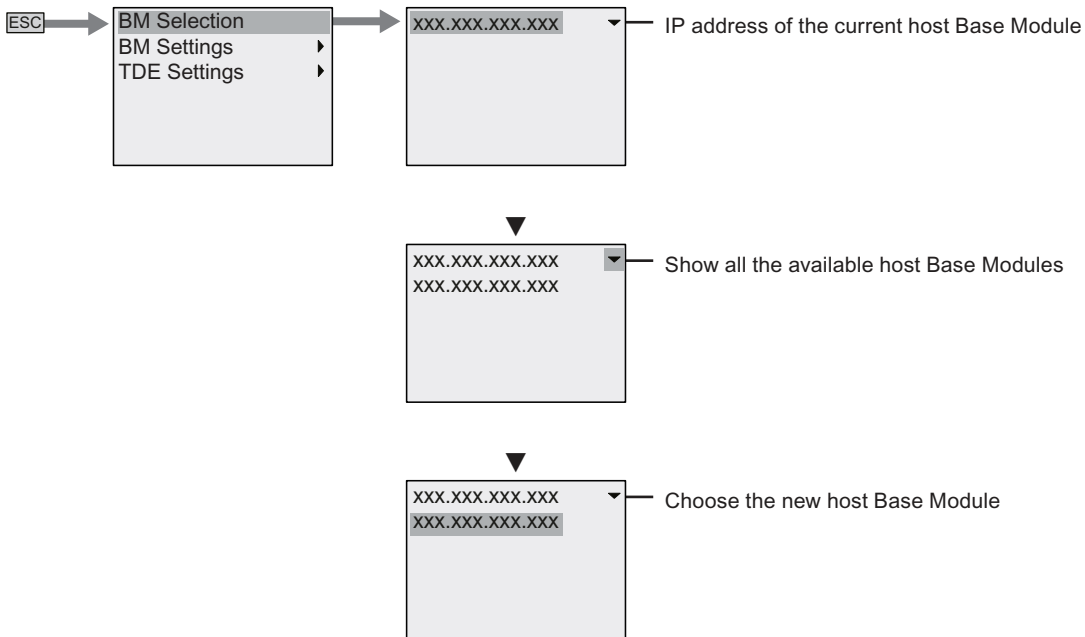

### D.2.4 BM settings menu

The Text Display allows you to view and configure settings of the connected Base Module in its BM settings menu.

### Program menu

The program menu is the same as that on the Base Module. See "Programming menu (Page 318)" for more information.



### Card menu

The card menu is the same as that on the Base Module. See "Card menu (Page 318)" for more information.



## Setup menu

The setup menu is different from that on the Base Module. See "Setup menu (Page 319)" for the complete setup menu for Base Module.

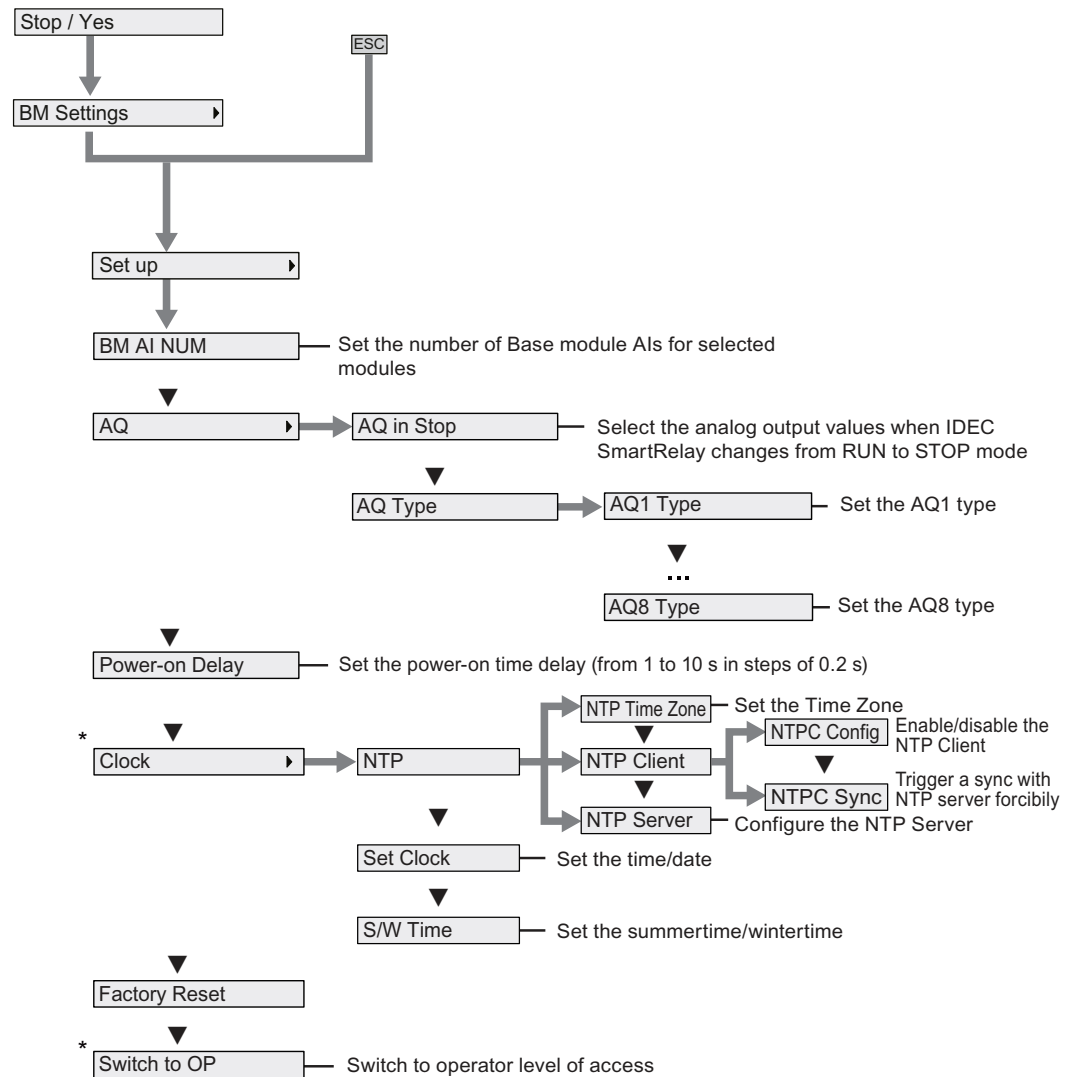

### Note

When IDEC SmartRelay is in RUN mode, only the menu commands with an asterisk (\*) are available in the above menu.



### Network menu

The network menu is the same as that on the Base Module. See "Network menu (Page 320)" for more information.



### Diagnostics menu

The diagnostics menu is the same as that on the Base Module. See "Diagnostics menu (Page 320)" for more information.

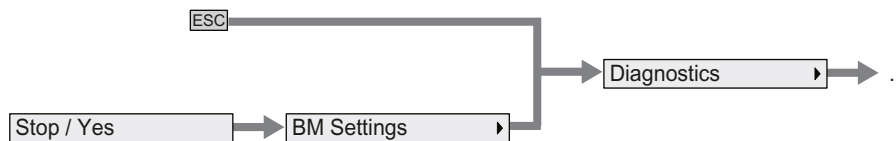

### Start menu

The start menu is the same as that on the Base Module. See "Start menu (Page 321)" for more information.

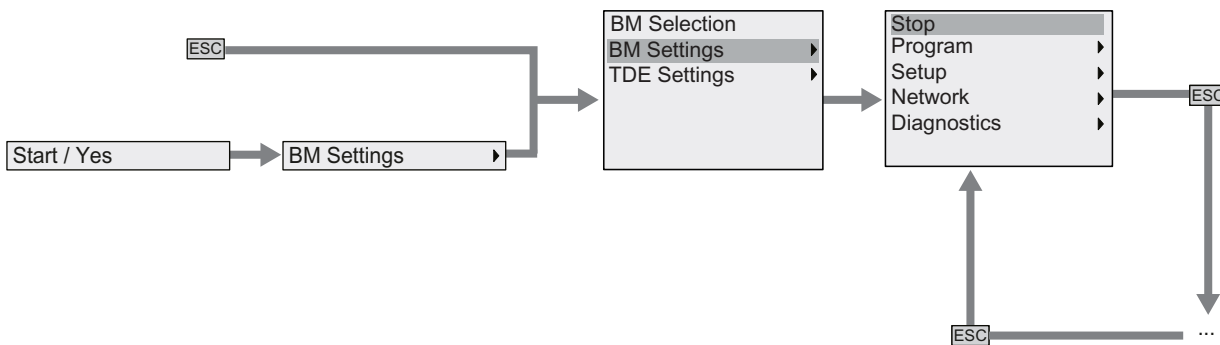

---

#### Note

The start screen of the Text Display is always the clock display when Base Module is in RUN mode.

---

## D.2.5 Text Display settings menu

The Text Display allows you to view and configure settings of the Text Display itself.

The following Text Display settings menu structure applies both when the connected Base Module is in RUN or STOP mode.

### Text Display setup menu

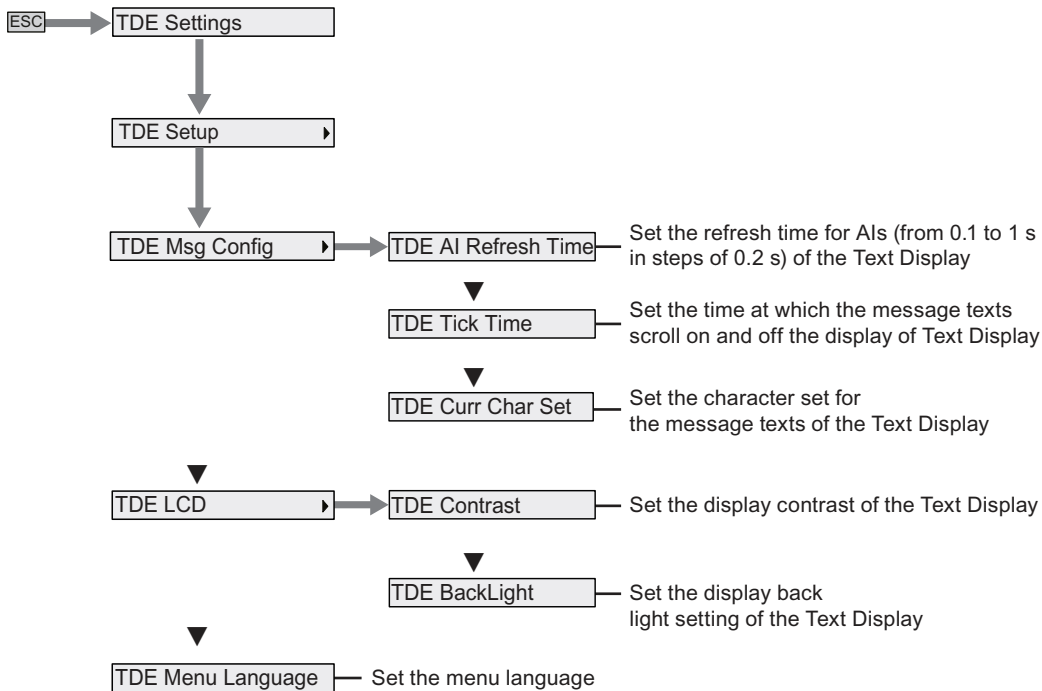

### Text Display network menu

You can use the menu below to set the FL1F-RD1 network configurations.

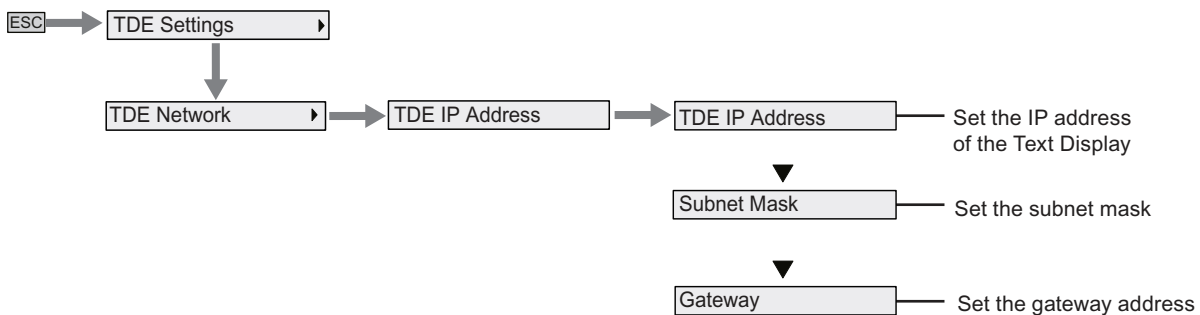

#### Note

The IP address of the Text Display is read-only when it is in RUN mode.

### Text Display diagnostics menu

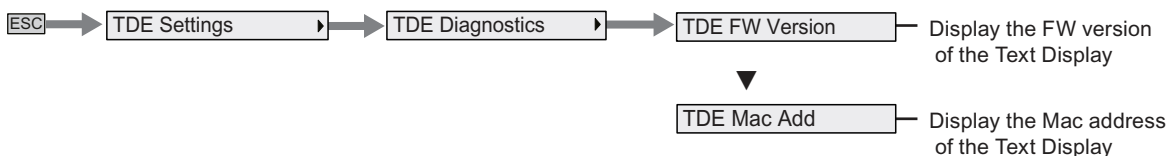



# Type numbers



## Modules

Variant	Type number
Base Modules (Base Module with display)	FL1F-H12RCE * FL1F-H12SCD * FL1F-H12RCA FL1F-H12RCC
Base Modules (Base Module without display)	FL1F-B12RCE * FL1F-B12RCA FL1F-B12RCC
Digital modules	FL1F-M08B2R2 FL1F-M08B1S2 FL1F-M08D2R2 FL1F-M08C2R2
Analog modules	FL1F-J2B2 FL1F-K2BM2
Text Display module with Ethernet interfaces	FL1F-RD1

\*: Also with analog inputs

## Accessories

Accessories	Type number
WindLGC	FL9Y-LP1CDW
User's Manual	FL9Y-1789
Mounting Clip for Base module	FL1F-PSP1PN05
Mounting Clip and Waterproof Gasket for Text Display	FL1F-KW1



# Abbreviations

# F

AM	Analog module
B1	Block number B1
BM	Base Module
C	IDEC SmartRelay device designation: integrated clock
Cnt	Count = Counter input
Dir	Direction (of count, for example)
DL	Data Log
DM	Digital Module
EM	Expansion Module
En	Enable = switching on (for example, clock generators)
FL1F device	The latest Base Module version, described in this manual
Fre	Input for frequency signals to be analyzed
GF	Basic Functions
Inv	Input for inverting the output signal
NAI	Network analog input
NAQ	Network analog output
NI	Network input
No	Cam (parameter of the timer)
NQ	Network output
Par	Parameter
R	Reset input
Ral	Reset all = Input for resetting all internal values
S	Set (latching relay, for example)
SF	Special functions
T	Time = parameter
TDE	Text Display with Ethernet interfaces
Trg	Trigger (parameter)
UDF	User-Defined Function



# Index

## B

- Backlight markers, 115
- Basic functions
  - AND, 119
  - AND, with edge, 120
  - NAND, 120
  - NAND, with edge, 121
  - NOT, 124
  - OR, 122
  - XOR, 124
- Basics on special functions, 125
- Block number, 53
- Blocks, 52

## C

- Certification and approvals
  - CE label, 10
  - cFMus, 10
  - C-tick label, 11
  - cULus, 10
- Ch by Ch ticking, 201
- Character set marker, 116
- Character sets, 197
- Circuit protection, 28
- Compatibility, 19
- Connectors, 51
- Constants and connectors, 113
- Counters
  - frequency trigger, 176
  - operating hours, 172
  - Up/down, 169
- Current impulse relay, 195

## D

- Data log, 257
- Days of the week, 157
- Demo versions, 289
- DIN rail, 20
- Display modules, 2

## E

- Error event diagnostics, 102
- Ethernet interface, 43
- Expansion modules, 2

## F

- Formatting micro SD cards, 273

## G

- Gain, 128
- GB-2312, 197

## H

- Hysteresis, 188

## I

- IDECE SmartRelay network setup, 16
- IDECE SmartRelay security
  - menu access protection, 59
  - network security, 281
  - program copy protection, 284
  - program password protection, 70
- IDECE SmartRelay software, 287
- IDECE SmartRelay structure, 4
- IDECE SmartRelay versions, 9
- Inputs
  - analog inputs, 114
  - cursor keys, 116
  - digital inputs, 113
  - inverting, 118, 129
  - Text Display function keys, 117
- Installation and removal
  - DIN rail mounting, 21
  - Text Display, 25
  - wall-mounting, 23
- Internet support, 336
- Inverter, 124
- ISO8859-1, 197
- ISO8859-16, 197
- ISO8859-5, 197
- ISO8859-9, 197

## L

- Latching relay, 194
- LED, 316
- Ln by Ln ticking, 201
- Logical inputs, 125



**M**

Master/slave mode, 100  
Maximum switched current, 40  
Memory markers, 115  
Memory space, 107  
Message ticking, 201

**N**

Network I/O, 117  
NTP, 94

**O**

On-/Off-times, 157  
On-delay, 134  
Open connectors, 117  
Operating states  
    Base Modules, 47  
    Expansion Modules, 47  
Outputs  
    analog outputs, 114  
    digital outputs, 114  
Overflow error, 228

**P**

Parameter assignment mode, 259  
Parameter inputs, 126  
Parameter protection, 127  
PC-IDEA SmartRelay mode, 290  
Program cycle, 313  
Program name  
    change, 70  
    character set, 69  
Program password  
    assign, 70  
    change, 72  
    deactivate, 73  
Programming mode, 63

**R**

Relay outputs, 308  
Retentivity, 127

**S**

Sensor connections, 32  
Setting default values  
    AI number, 270  
    clock, 265  
    contrast and backlight, 267  
    menu language, 269  
    start screen, 271  
Setup with different voltage classes, 18  
Seven-day time switch  
    examples, 158  
    settings, 158  
SF, 125, 129  
Shift register bits, 116  
Shift-JIS, 197  
Signal status transitions, 31  
Special functions, 129  
    Analog amplifier, 192  
    Analog comparator, 184  
    Analog differential trigger, 182  
    Analog filter, 230, 238  
    Analog math, 225  
    Analog math error detection, 228  
    Analog multiplexer, 210  
    Analog ramp control, 213  
    Analog trigger, 179  
    Analog watchdog, 189  
    Astronomical clock, 164  
    Asynchronous pulse generator, 147  
    Average value, 236  
    Basics, 125  
    Current impulse relay, 195  
    Edge-triggered interval time-delay relay, 145  
    Frequency trigger, 176  
    Integer/Float Converter, 240  
    Interval time-delay relay, 143  
    Latching relay, 194  
    Max/Min, 232  
    Message texts, 197  
    Off-delay, 137  
    On-/off-delay, 139  
    On-delay, 134  
    Operating hours counter, 172  
    PI controller, 217  
    Pulse Width Modulator (PWM), 222  
    Random generator, 149  
    Relays, 194, 195  
    Retentive on-delay, 141  
    Seven-day time switch, 156  
    Shift register, 208  
    Softkey, 206  
    Stairwell light switch, 151  
    Stopwatch, 167  
    Twelve-month time switch, 159  
    Up-down counter, 169  
Startup marker, 115

Summertime/wintertime conversion, 90  
Supported operating systems, 288  
Switch to RUN mode, 74

## T

Text Display, 7  
    backlight lifetime, 311  
    display lifetime, 311  
    function keys, 2  
    LCD lifetime, 311  
    menus, 2  
    power-up screen, 2  
Time response, 126  
Timebase, 126, 134  
Timer accuracy, 126  
Timers  
    Astronomical clock, 164  
    Asynchronous pulse generator, 147  
    Dual-function switch, 153  
    Edge-triggered interval time-delay relay, 145  
    Interval time-delay relay/Pulse output, 143  
    Off-delay, 137  
    On-/off-delay, 139  
    On-delay, 134  
    Random generator, 149  
    Retentive on-delay, 141  
    Seven-day time switch, 156  
    Stairwell light switch, 151  
    Stopwatch, 167  
    Twelve-month time switch, 159  
Timing inaccuracy, 126

## U

User-Defined Function (UDF), 253

## V

Voltage levels, 117

## W

Web server, 243  
    logon, 245  
    logout, 251  
Wire ferrules, 26

## Z

Zero division error, 228  
Zero offset, 128

## **Additional support**

At our Internet address (<http://www.idec.com/smartrelay>) you can quickly and easily find answers to your queries about IDEC SmartRelay.